

International Association of Fire Fighters

# First Responder Operations

## Participant Guide

June 2014, United States Edition



Developed by

**HazMat/WMD Training Department**

International Association of Fire Fighters  
1750 New York Avenue, NW  
Washington, DC 20006

Funded by





## Disclaimer

Disclaimer and Notice of Copyright © 2013

The programs developed by the International Association of Fire Fighters (IAFF) are funded by one or more of the following federal agencies:

- National Institute for Occupational Safety and Health (NIOSH)
- National Institute of Environmental Health Sciences (NIEHS)
- Department of Energy (DOE)
- Department of Transportation (DOT)
- Department of Homeland Security (DHS)
- The Federal Government of Canada

Every effort has been made to ensure that the information contained in course materials is accurate and reflects the latest scientific knowledge on its subject matter. However, proper training for, and understanding of, any emergency response situation is the responsibility of the responding agency or organization, and not of the IAFF. Furthermore, the IAFF and/or its agents cannot warranty that the material presented in this program complies with requirements found in local policies or procedures.

To assist departments in building a self-sufficient training program, the IAFF provides train-the-trainer programs for all curricula. Students who successfully complete a train-the-trainer program are authorized to make use of these IAFF training materials to train others, in accordance with local, state or provincial laws, regulations or policies for training programs.

These materials are copyrighted and may not be sold. Reproduction of these materials in the course of conducting any for-profit training program is prohibited. Exact and complete copies of the materials may be reproduced solely for the purpose of assisting departments in building a self-sufficient, non-profit training program. Permission to duplicate these materials for any purpose may be revoked by the IAFF at any time for failure to comply with these terms.

Delivery of this program is free of charge by the IAFF, as federal funding permits. For information in obtaining delivery of this program by the IAFF, please contact the Hazardous Materials/Weapons of Mass Destruction Training Department at [hazmat@iaff.org](mailto:hazmat@iaff.org) or 202-737-8484.



## Preface

### Introduction

The IAFF developed First Responder Operations (FRO) for those fire, rescue, emergency medical service (EMS) personnel and other personnel who may respond to incidents involving hazardous materials (hazmats) and/or weapons of mass destruction (WMDs).

This course will focus on enabling participants to:

- Protect their health and safety before, during and after responding to potential or actual hazmat/WMD incidents
- Acquire the knowledge and skills needed to recognize and identify the clues that determine the presence of hazmats/WMDs
- Learn how to research and evaluate technical information
- Practice making decisions and executing responder actions in a team-based learning environment

Responding to hazmat/WMD incidents will require emergency responders to systematically apply a specific decision-making process for safely operating at hazmat/WMD incidents. This course articulates a decision-making process, relating how to think, along with what to do and what not to do.

The FRO course is a three-day (24-hour) participant-centered, instructor-led training program. This course is delivered in three 8-hour days. Class size of 25 is recommended.

The activities are designed by responders, for responders, to address key issues related to their health and safety at hazmat/WMD incidents. The overall goal of the program is to train responders to use Analyze, Plan, Implement and Evaluate (APIE): A Risk-Based Response Process to effectively respond to incidents involving hazmats/WMDs, and reduce responder injury and death.

This course also gives responders the opportunity to learn new strategies they can use to help decrease injury and death in their departments. Topics include pre-incident planning, as well as the specific actions for each step in APIE: A Risk-Based Response Process.

### Compliance

Attending this training satisfies the hazardous materials training requirements as stated in Title 29 Code of Federal Regulations (CFR) 1910.120 Hazardous Waste Operations and Emergency Response (HAZWOPER). However, 1910.120 (q)(6)(ii) requires that the employer certify that an individual has met all of the requirements and competencies identified under 1910.120(q)(6)(i) and 1910.120 (q)(6)(ii). It is still the responsibility of the employer/department to ensure that all competencies are met. Additional information that needs to be covered includes ensuring the employee has an understanding of the relevant emergency response plans (ERPs) as well as the standard operating procedures/guidelines (SOPs/SOGs) for the authority having jurisdiction (AHJ).



## How This Course has Changed from the Previous Version

The most significant change from the previous edition of First Responder Operations (2005) is the opportunity for participants to earn certification through the National Board on Fire Service Professional Qualifications (The Pro Board). The curriculum has been updated to meet the competencies in NFPA® 472, Standard for Competence of Responders to Hazardous Materials/Weapons of Mass Destruction Incidents, 2013 Edition at the **Awareness, Core Operations** and Mission-Specific **Personal Protective Equipment (PPE)** and **Product Control** levels. These levels have been included in order to facilitate participants' ability to fulfill the OSHA training requirements, as well as the requirements for NFPA® 1001, Standard for Fire Fighter Professional Qualifications, at the Fire Fighter I level.

As a result of this major change, the curriculum will involve hands-on activities and performance evaluation. Participants of hands-on activities will need to be fit-tested and trained to use self-contained breathing apparatus (SCBA) and structural fire fighter protective clothing (SFPC) prior to attendance. Fire service organizations requesting this training will also be required to provide a skills evaluation site and water supply, as well as the equipment required for participants to don/doff the PPE, perform emergency decontamination, perform defensive product control and undergo technical decontamination.

The IAFF will continue to provide this curriculum to non-fire service emergency responders, first receivers and other allied professionals requiring awareness and operations level training in accordance with the HAZWOPER regulation. For these individuals, the course includes written pre- and post-test, a certificate of completion of HAZWOPER training requirements, and with a passing score of 70 percent on the post-test—a Pro Board certification at the Awareness level of NFPA® 472. Participants, who have not been fit-tested or trained in the use of SCBA or SFPC, will not be permitted to participate in the hands-on activities.

Additionally, the IAFF will continue its effort to train local instructors in preparation for indirect training. Course materials, registration and survey forms are provided to these local instructors, to deliver training within their departments. Organizations seeking to train their own instructor cadre to deliver FRO may request a train-the-trainer program which includes a thorough review of the course materials and opportunities to practice delivery of the program. For additional information regarding indirect training, please contact the IAFF's HazMat/WMD Training Department.

It is important to note that students of indirect deliveries will not receive Pro Board certification. Pro Board certification testing may only be performed by IAFF master instructors. Participants of indirect training will receive a certificate of completion of the HAZWOPER training requirements for the awareness and operations levels described in the OSHA regulation 29 CFR 1910.120.





## Table of Contents

<b>Module 1 - Introduction</b> .....	<b>1</b>
Lesson 1.1 - Course Goals, Laws and Regs.....	1
Lesson 1.2 - Medical Surveillance .....	17
Lesson 1.3 - APIE: A Risk-Based Response Process .....	35
<b>Module 2 - Analyze the Problem</b> .....	<b>39</b>
Lesson 2.1 - Recognizing Hazardous Materials.....	39
Lesson 2.2 - Placards, Labels and Markings .....	51
Lesson 2.3 - Emergency Response Guidebook.....	83
Lesson 2.4 - NIOSH Pocket Guide and Chemical/Physical Properties.....	91
Lesson 2.5 - Health and Safety Threats.....	121
Lesson 2.6 - WMD Incidents .....	131
Lesson 2.7 - Shipping Papers and Facility Documents.....	157
Lesson 2.8 - Container Shapes and Sizes.....	215
Lesson 2.9 - Pre-Incident Planning .....	269
Lesson 2.10 - Using the APIE Model .....	279
<b>Module 3 - Plan the Initial Response</b> .....	<b>295</b>
Lesson 3.1 - Response Objectives and Action Options.....	295
Lesson 3.2 - Personal Protective Equipment.....	305
Lesson 3.3 - Decontamination .....	333
<b>Module 4: Implement the Planned Response</b> .....	<b>339</b>
Lesson 4.1 - Scene Control and Responder Roles.....	339
<b>Module 5 - Evaluate the Progress</b> .....	<b>355</b>
Lesson 5.1 - Terminate the Incident.....	355
Lesson 5.2 - Final Simulation.....	363
<b>Cross-Reference to OSHA 1910.120 and NFPA® 472 Standard</b> .....	<b>A-1</b>
<b>Glossary</b> .....	<b>A-8</b>



<b>APIE: A Risk-Based Response Model .....</b>	<b>A-27</b>
APIE Checklist .....	A-28
APIE Worksheet.....	A-29
Chemical/Physical Properties Identification Form.....	A-30
<b>Performance Checklists.....</b>	<b>A-34</b>
Checklist #: 472-OPS-001 Emergency Decon (Mandatory).....	A-34
Checklist #: 472-OPS-MS-001 Foam Application/Vapor Suppression .....	A-35
Checklist #: 472-OPS-MS-002 Absorption.....	A-36
Checklist #: 472-OPS-MS-003 Adsorption.....	A-37
Checklist #: 472-OPS-MS-004 Damming.....	A-38
Checklist #: 472-OPS-MS-005 Diking.....	A-39
Checklist #: 472-OPS-MS-006 Dilution .....	A-40
Checklist #: 472-OPS-MS-007 Diversion.....	A-41
Checklist #: 472-OPS-MS-008 Retention.....	A-42
Checklist #: 472-OPS-MS-009 Remote Valve Shut-Off .....	A-43
Checklist #: 472-OPS-MS-010 Vapor Dispersion .....	A-44
Checklist #: 472-OPS-MS-011 PPE.....	A-45
Checklist #: 472-OPS-MS-012 Undergoing Technical Decontamination .....	A-46
<b>United Nations' Globally Harmonized System of Classification.....</b>	<b>A-47</b>
OSHA Fact Sheet on Training Requirements .....	A-47
OSHA Brief on Hazard Communication Standard: Labels and Pictograms.....	A-49
OSHA Brief on Hazard Communication Standard: Safety Data Sheets .....	A-58



## Module 1 - Introduction

### Lesson 1.1 - Course Goals, Laws and Regs

#### Lesson Objectives

After this lesson, you will be familiar with the course goals and objectives, as well as the requirements for passing the knowledge and skills evaluations.

#### NFPA® 472, 5.1.1.3

Identify and describe governmental occupational health and safety regulations.



#### Expected Course Outcomes

*Use the space below for your notes.*

---

---

---

---

---

---

---

---





## Course Goals

### The IAFF's Goal



As part of its mission, the International Association of Fire Fighters (IAFF) works to place its members on a higher plane of skill and efficiency.

The mission of the IAFF's HazMat/WMD Training Department is to educate emergency responders about strategies to safeguard their health and safety, and reduce occupational deaths and injuries related to hazardous materials and weapons of mass destruction response, so they can better protect the communities they serve.

Through this course, the IAFF is working to ensure that all emergency responders have the knowledge and skills to safely stabilize and/or mitigate incidents involving hazardous materials (hazmats) and weapons of mass destruction (WMDs).





## Occupational Safety and Health Administration



OSHA regulation requires responders at the awareness and operations levels to have the following knowledge and skills. A cross-reference between the requirements below and the content of this guide has been placed in the appendices beginning on page A-1.

### Awareness Level Knowledge and Skills

- An understanding of what hazardous substances are, and the risks associated with them in an incident
- An understanding of the potential outcomes associated with an emergency created when hazardous substances are present
- The ability to recognize the presence of hazardous substances in an emergency
- The ability to identify the hazardous substances, if possible
- An understanding of the role of awareness personnel as described in the employer's emergency response plan, including site security and control and the Emergency Response Guidebook (ERG)
- The ability to realize the need for additional resources, and to make appropriate notifications to the communication center

### Operations Level Knowledge and Skills

- Knowledge of the basic hazard and risk assessment techniques
- Know how to select and use proper personal protective equipment provided to the first responder operational level
- An understanding of basic hazardous materials terms
- Know how to perform basic control, containment and/or confinement operations within the capabilities of the resources and personal protective equipment available with their unit
- Know how to implement basic decontamination procedures
- An understanding of the relevant standard operating procedures and termination procedures

Participants who complete this course, will receive a certificate of completion indicating they have received training at the awareness and operations levels as required by OSHA 1910.120.

### Rationale

As an emergency responder, you will respond to a variety of incidents that may initially appear routine, but subsequently turn out to involve hazardous materials or WMDs which will require special handling. With respect to hazardous materials, keep the following factors in mind.

Hazardous materials are virtually everywhere—from the overturned tanker to the EMS call. Furthermore, many substances become hazardous when heated or combined with other substances—factors commonly encountered during emergency incidents.

Hazardous materials do not frequently raise concern, because typically they are contained or enclosed. They become dangerous when they threaten to, or actually get out of their containers (exposing the public and potentially causing harm to life, property and the environment).

An understanding of hazardous materials and how they can affect you improves your ability to take the proper precautions to guard against being exposed to them.

And, if you do not take the proper safety precautions, you will put health and safety at risk—your own, and that of others.



## National Fire Protection Association® (NFPA®)



The competencies described in NFPA® 472: Standard for Competence of Responders to Hazardous Materials/Weapons of Mass Destruction Incidents, 2013 Edition are also covered in this course. Specifically, this curriculum covers:

- Chapter 4: Competencies for Awareness Personnel
- Chapter 5: Core Competencies for Operations Level Responders
- Chapter 6: Competencies for Operations Level Responders Assigned Mission-Specific Responsibilities
  - Section 6.2: Personal Protective Equipment
  - Section 6.6: Perform Product Control

A cross-reference between the competencies outlined in NFPA® 472 and the content of this guide has been placed in the appendices beginning on page A-1.

## Pro Board Certification



Participants who score 70 percent or higher on the written exam, and pass the corresponding skills performance evaluation, will be certified through the National Board on Fire Service Professional Qualifications (The Pro Board).

Candidates who are certified by an accredited agency have:

- Recognition for demonstrating proficiency in meeting the NFPA® professional qualification standards
- A permanent record of the accomplishment
- Transferability/portability of qualifications, as reciprocity among certifying entities means Pro Board certification will be recognized by:
  - Members' departments as members seek promotions
  - Other departments should members seek to transfer
- Improved employment opportunities





## Terminal Objectives



After completing this course, you will be able to perform the duties of awareness and operations level personnel when responding to hazmat/WMD incidents in accordance with OSHA 1910.120 training requirements, NFPA<sup>®</sup> 472 Chapters 4, 5, 6.2 and 6.2,<sup>1</sup> and the IAFF's risk-based response process.

- Analyze the incident to identify the problem and the behavior of hazmat/WMDs and containers present.
- Plan an initial response, develop an incident action plan and communicate that plan in accordance with standard operating procedures/guidelines (SOPs/SOGs).
- Implement the planned response while observing operations and outcomes.
  - Use PPE at hazmat/WMD incidents.
  - Control products at hazmat/WMD incidents.
- Evaluate the progress to assess the effectiveness of the actions taken to stabilize the incident, and protect people, property and the environment.



<sup>1</sup> NFPA 472<sup>®</sup> Standard for Competence of Responders to Hazardous Materials/Weapons of Mass Destruction, 2013 Edition.





## Laws and Regulations

### Events Leading to Laws and Regulations

#### 1962 Rachel Carson's Silent Spring



It suggested that the pesticide DDT may lead to death in apes and reproductive abnormalities in birds.

The food chain links these risks to humans: insects consume DDT, animals eat insects, and people subsequently eat animals.

#### 1969 Florida Everglades Fertilizer Fire

- The Everglades fire prompted the first workers compensation lawsuit that identified a specific fire as the source of illness and death of fire fighters exposed to toxic products of combustion.

#### 1976 Love Canal

- Tons of chemicals had been dumped into this canal over a period of 60 years by nearby Hooker Chemical Company.
- In 1953, the company filled in the canal, developed housing on it, and sold a parcel of the property to the Niagara Falls School Board for the building of a new elementary school.
- Respiratory problems, immune disorders and cancer rates became unexpectedly high.
- Such medical abnormalities were noted by company officials and by the city government, but not shared with the public.
- Under the Carter administration, the homes were evacuated and the school closed.



#### 1984 Union Carbide – Bhopal, India

- Methyl isocyanate (MIC) was accidentally released.
- A gas cloud of the MIC slowly drifted through the cool night air resulting in 3,800 dead and 200,000 injuries.
- Approximately 10 survivors still die every month as a result of their exposures.



## Time Line of Protective Legislative Action

### Summary of Federal Regulations

1976 Resource Conservation and Recovery Act (RCRA)

1980 Comprehensive Environmental Response,  
Compensation, and Liability Act (CERCLA)



### Legislation to Decrease Casualties and Injuries from Accidents Involving Chemicals



1983 Hazard Communication (HAZCOMM) (29 CFR 1910.1200)

2012 Revised Hazard Communication Final Rule brings the United States into alignment with the Globally Harmonized System of Classification and Labeling of Chemicals (GHS)

1986 Hazardous Waste Operations and Emergency Response (HAZWOPER) (29 CFR 1910.120)

### National Consensus Standards

1989 National Fire Protection Association® (NFPA®)  
standards for hazmat response



- **NFPA® 471: Recommended Practice for Responding to Hazardous Materials Incidents** (Withdrawn after 2002)
- **NFPA® 472: Standard for Competence of Responders to Hazardous Materials/Weapons of Mass Destruction** (2013 Edition)
- **NFPA® 473: Standard for Competence of EMS Personnel Responding to Hazardous Materials/Weapons of Mass Destruction** (2013 Edition)
- **NFPA® 475: Recommended Practice for Responding to Hazardous Materials Incidents/Weapons of Mass Destruction** (Proposed for 2016)
- **NFPA® 1072: Standard for Hazardous Materials/ Weapons of Mass Destruction Emergency Response Personnel Professional Qualifications** (Proposed for 2016)

Following are descriptions of regulations that have pioneered changes in emergency response, particularly in the areas of hazardous materials and worker health and safety. This summary information is not intended to be all inclusive or to provide legal interpretation.



## Summary of Federal Regulations

### Environmental Protection Agency (EPA)



The EPA is responsible for regulation, control and management of air and water pollution; hazardous waste disposal; and licensing of pesticides, fungicides and rodenticides. The Superfund Amendments and Reauthorization Act (SARA) legislation expanded EPA's responsibilities to include occupational health and safety. EPA law (40 CFR 311) applies the OSHA regulation (29 CFR 1910.120) to those states and local government workers not covered by OSHA law.

### RCRA

In 1976, Congress passed the Resource Conservation and Recovery Act (RCRA) which **allowed federal government regulation of the creators, transporters and treatment/disposal operators of hazardous wastes.** This was the federal government's first effort at managing hazardous wastes and their effects on public health and the environment. However, this act did not affect the many hazardous waste sites created prior to the passage of RCRA—many of which were abandoned, and contained unknown quantities of unknown wastes.

### CERCLA

In order to address the cleanup of those sites not covered under RCRA, Congress enacted the Comprehensive Environmental Response, Compensation and Liability Act of 1980 (CERCLA). CERCLA quickly became known as the Superfund Act, in part because it created **funds for the cleanup and proper reclamation of abandoned and inactive hazardous waste disposal sites.** Specifically, this act created a five-year program that allowed the government to spend \$1.6 billion to clean up hazardous waste sites. It further empowered the federal government to negotiate with responsible parties for cleanup of hazardous waste sites. Where negotiations broke down, the federal government was allowed to seek legal actions forcing those parties to either clean up the site or assume financial responsibility for the cleanup costs.

### SARA

In an effort to overcome these obstacles, and after much discussion and many drafts, Congress passed the Superfund Amendments and Reauthorization Act of 1986 (SARA). **The overriding purpose of SARA was to expand and accelerate the cleanup efforts originally established by CERCLA.** In order to do this, SARA provided additional funding (\$7.5 billion) and time (an additional five years) to the original Superfund program. SARA also made changes in the law that **promote speedier action and a more definitive direction for the cleanup efforts.**



## Occupational Safety and Health Administration (OSHA)

OSHA is responsible for promulgating legally enforceable health and safety standards to protect workers. OSHA standards fall into four categories:



- General Industry
- Maritime
- Construction
- Agriculture

### Occupational Illness and Injury

Facilities with 11 or more employees must maintain records of occupational injuries and illnesses as they occur. An **occupational injury** is an injury such as a cut, fracture, sprain or amputation that results from a work-related accident or from exposure involving a single incident in the work place. An **occupational illness** is any abnormal condition or disorder other than one resulting from an injury, caused by exposure to environmental factors associated with employment. Included are acute and chronic illnesses or diseases that may be caused by inhalation, absorption, ingestion or direct contact with toxic substances or harmful agents.

### Safety and Health Programs

All employees are required to comply with a health and safety program. Most facilities choose to extend this program to contractors, subcontractors, visitors, regulatory agency personnel and site owners or their representatives. The rights and responsibilities of employees and the employer are described by OSHA. OSHA has several standards that apply to the health and safety of workers. These are described in the table on the next page.



<b>OSHA 29 CFR</b>	<b>Description</b>
1910.95 Occupational Noise Exposure	Identifies the type of protection necessary against a variety of noise exposures. In addition, the standard requires facilities to establish a hearing conservation program and communicate the effects of noise exposure.
1910.120 HAZWOPER	Deals with hazardous waste operations and emergency response.
1910.133 Eye and Face Protection	Identifies acceptable eye and face protection. Eye and face protection are required when a reasonable probability of injury exists.
1910.134 Respiratory Protection	The primary objective of the Respiratory Protection Standard is to control occupational disease caused by breathing contaminated air. Breathing air is contaminated when harmful dusts, fogs, fumes, mists, gases, sprays or vapors exist in the work place.
1910.135 Occupational Head Protection	Requires workers to wear protective helmets when working in areas where the potential for head injury exists, due to falling objects.
1910.136 Occupational Foot Protection	Protects employees working in areas where harmful foot exposure exists. Protective footwear must be issued when hazards from falling and/or rolling objects, objects piercing the sole, or even electrical hazards are present in the work place.
1910.138 Occupational Hand Protection	Protective hand protection is mandated when employees' hands are exposed to one or more of the following conditions: skin absorption of harmful substances, severe cuts or lacerations, severe abrasions, punctures, chemical burns, thermal burns and/or temperature extremes.
1910.146 Confined Space	Identifies requirements for confined space entry and practices/procedures to protect employees from the hazards of permit-required confined spaces.
1910.147 The Control of Hazardous Energy	More commonly known as the Lockout/Tagout (LO/TO) Standard, it establishes minimum performance requirements for control of energization (start up) of machines or equipment, or the release of stored energy that could cause injury. This standard requires employers to publish a written LO/TO program. Facilities are required to institute policies and procedures which protect workers from mechanical hazards during routine maintenance.



OSHA 29 CFR	Description
1910.1030 Bloodborne Pathogens	Covers occupational exposure to blood or other potentially infectious materials. This standard focuses on communicable disease such as HIV, Hepatitis B and Hepatitis C.
1910.1200 Hazard Communication	Requires employers to identify the hazards present in the work place.

### HAZWOPER (OSHA 29 CFR 1910.120)

OSHA's 29 CFR 1910.120 deals with hazardous waste operations and emergency response. The standard targets three separate groups of workers, including employees who:

- Work at RCRA facilities
- Respond to emergencies
- Work at clean-up sites dealing with hazardous substances

HAZWOPER addresses six main issues that have an impact on fire fighters and other emergency response personnel:

- Medical surveillance programs
- Training programs
- Emergency response planning
- Incident management systems
- Decontamination procedures
- Equipment selection and maintenance

Prior to 1986, the United States Department of Labor's OSHA regulations did not apply to state and local government employees, such as fire fighters. While some OSHA regulations had already been established, they were designed to protect standard workplace employees (primarily private sector) who might be exposed to work-related hazards. In order to balance this inequity and extend protection to all workers, a special regulation for public employees (29 CFR 1910.120) was written and added to the OSHA law. At this point, EPA's regulation (40 CFR 311) mirrors OSHA's regulations (29 CFR 1910.120).

This new law also required the EPA to issue its own set of regulations for workers who:

- Handle chemicals at hazardous waste sites (uncontrolled as well as licensed sites)
- Respond to emergencies involving hazardous materials

Regulation 29 CFR 1910.120 is divided into 17 paragraphs, a through q, and includes requirements such as medical monitoring, health and safety plans and site characterization. Employees who work at RCRA facilities are covered by paragraph p. Employees who work at clean-up sites are covered by paragraphs b through o. Fire fighters who handle emergency response are covered by paragraph q, which is described on the next page.



## Paragraph Q — Emergency Response

This paragraph covers employees who are responding to an emergency response regardless of the location. Elements of paragraph q include:

- Development of an Emergency Response Plan with the following elements:
  - Pre-emergency planning with outside parties
  - Personnel roles, lines of authority and communication
  - Emergency recognition and prevention
  - Safe distances and places of refuge
  - Site security and control
  - Evacuation routes and procedures
  - Decontamination procedures
  - Emergency medical treatment and first aid
  - Emergency alerting and response procedures
  - Critique of response and follow-up
  - PPE and emergency equipment
- Procedures for handling emergency response
- Skilled support personnel
- Specialist employees
- HAZWOPER specifies five levels of training, each progressively leading to more response capability and offensive actions. The five levels (in accumulating order of complexity and responsibility) are:
  - **First Responder Awareness Level:**
    - ◆ Trained to recognize that a hazardous materials emergency exists, and then take protective actions and execute the notification process—in other words, keep people away and call for help.
  - **First Responder Operations Level:**
    - ◆ Trained to analyze the emergency and implement defensive actions, such as isolating the area, containing/confining the release, establishing decontamination, and initiating an Incident Management System (IMS).
  - **Hazardous Materials Technician:**
    - ◆ Trained to determine the hazards of the release and implement offensive actions by performing specialized control functions to mitigate the emergency, e.g., repairing a container. These skills are beyond those taught in this course.
  - **Hazardous Materials Specialist:**
    - ◆ Specialists support the technician with specialized knowledge, and advise the incident commander about specific hazardous materials present.





- **On-site Incident Commander:** The most senior official at the scene who is responsible for making the decisions and assigning duties
  - ◆ Training requirements include initial training to the operations level, plus sixteen additional hours of incident command training, specifically related to hazardous materials response

HAZWOPER also provides regulatory requirements for:

- Trainers
- Refresher training
- Medical surveillance and consultation
- Chemical protective clothing
- Post-emergency response operations (includes possible removal of hazardous substances, health hazards and contaminated materials)

## Hazard Communication Standard (OSHA 29 CFR 1910.1200)

OSHA has written a standard that requires employers to identify the hazards present in the work place. The Hazard Communication Standard, written in 1987, outlines methods for identifying and communicating the presence of hazards. Also known as the employee Right-to-Know law, the hazard communication standard applies to all chemicals that pose hazards to workers. This standard categorizes chemicals based on their threat to human health. Hazards at hazardous waste operations and emergency response sites can be classed into two categories: safety hazards and chemical hazards.

Chemical hazards pose either a health hazard or a physical hazard to the worker. While there are two broad categories of hazards, the hazard communication standard only addresses the chemical hazards present in the work place.

Safety hazards consist of hazards such as noise or thermal extremes. Safety hazards result from conditions in the work place that might harm workers, and can be identified using good hazard communication labels. Safety hazards include:

- High noise levels
- Oxygen deficient or enriched conditions
- Shock hazards
- Static discharges
- Mechanical hazards
- Thermal extremes
- Poor ergonomics
- Hazards from welding/cutting/brazing operations
- Excavation hazards
- Hazards from ionizing radiation



## Hazardous Materials Transportation Act



This act gives the Department of Transportation (DOT) regulatory authority to protect the public from the possible risks associated with the transportation of hazardous substances. To that end, the DOT establishes transportation regulations such as the placarding and labeling of hazardous materials containers, and places limitations on the quantities and/or types of materials that may be transported under certain conditions. In addition, the DOT oversees inspection and compliance with these regulations. Detailed information on DOT regulations can be found in Titles 33 and 49 of the Code of Federal Regulations.

## National Fire Protection Association® (NFPA®)



NFPA® has identified the minimum competencies that responders to hazardous materials/WMD incidents should possess. They are specified within NFPA® 472 for the purpose of reducing accidents, injuries, illnesses, disabilities and deaths that occur during—and result from—incidents involving hazardous materials.

This standard covers competencies for first responders as they accumulate increasing levels of training. Each of the cumulative levels of training includes minimum competencies for the responder. When hazardous materials are involved, emergency personnel need to respond in accordance to—and within the limits of—the training they have received. (Any given response will also be affected by the availability of appropriate protective equipment and clothing, and other supplementary resources.)



## State and Local Regulations

Many state and local governments develop their own regulations pertaining to the manufacture, storage and transportation of hazardous materials within their jurisdictions. While these regulations must at least meet the minimum federal requirements and should not contradict federal regulations, they may be somewhat different from federal law. Such irregularities can create confusion from state to state, and possibly from jurisdiction to jurisdiction.

Title III of SARA mandates that each state establish a State Emergency Response Commission (SERC). The SERC then determines how many Local Emergency Planning Committees (LEPCs) or local emergency planning districts should be established in the state. LEPCs must include representatives from the state and local governments, police and fire departments, civil defense (homeland protection), public health organizations, environmental agencies, medical treatment facilities, industry, media and community groups.

Each LEPC is expected to:

- Develop a district-wide emergency response plan (which must be exercised and validated annually).
- Conduct commodity flow studies pertaining to hazardous materials transportation.
- Help develop emergency plans for the storage and use of hazardous materials.
- Conduct public education programs.
- Organize regular LEPC meetings and activities.
- Receive and publicly distribute Tier II information upon request (reporting what chemicals are stored at specific sites).
- Evaluate available resources.

## Authority Having Jurisdiction

An organization, office or individual responsible for enforcing the requirements of a code or standard, or for approving equipment, materials, an installation or a procedure.<sup>1</sup>

### Emergency Response Plans (ERPs) and Standard Operating Procedures/Guidelines (SOPs/SOGs)

Personnel at the awareness level and responders at the operations level should be able to identify the location of both the ERP and SOPs/SOGs of the authority having jurisdiction (AHJ).

<sup>1</sup> NFPA® 472, 2013 Edition, 3.2.2



Page left blank intentionally.



## Lesson 1.2 - Medical Surveillance

### Lesson Objectives



After completing this lesson, you will be able to:

- Discuss the causes of fire fighter fatalities, injuries and illnesses, including the cumulative and/or ongoing exposures to occupational health risks.
- Discuss the importance of early detection of occupational illnesses and diseases in treatable stages.
- Describe the components of a medical surveillance program.
- Review local exposure reporting procedures.
- Discuss the requirements for assessing responders' health, as outlined in NFPA® 1500.

### Fire Fighter Fatalities<sup>1</sup>

- Eighty three (83) fire fighters died while on duty in 2011. In that same time period, 73 fire fighters died of cancer.
- Activities related to emergency incidents resulted in the deaths of 45 fire fighters.
- Twenty-eight (28) fire fighters died while engaging in activities at the scene of a fire.
- Eleven (11) fire fighters died while responding to, or returning from, emergency incidents.
- Heart attacks were the most frequent cause of death, with 48 fire fighter deaths.
- Eight (8) fire fighters died while they were engaged in training activities.

### Fire Fighter Injuries<sup>2</sup>

- A total of 70,090 fire fighter injuries in the line of duty were reported in 2011.
- In addition to injuries, there were 9,000 exposures to infectious diseases, and 23,400 exposures to hazardous conditions.
- Almost half—30,505 or 43.5% of all fire fighter injuries occurred during fireground operations.
- An estimated 14,905 injuries occurred at nonfire emergency incidents, 3,870 while responding/returning from an incident, 7,515 during training activities, and 13,295 occurred during other on duty activities.
- The major types of injuries during fireground operations were: strain, sprain, muscular pain (50.7%); wound, cut, bleeding, bruise (14.5%); thermal stress (6.9%) burns (6.2%). Strains, sprains and muscular pain accounted for 61.1% of all nonfireground injuries.
- The leading causes of fireground injuries were overexertion, strain (28.4%) and fall, slip, jump (21.0%).

1 United States Fire Administration: Firefighter Fatalities in the United States in 2011, July 2012.  
2 United States Firefighter Injuries - 2011, National Fire Protection Association®

### Health and Safety Standards



**NFPA® 1500: Fire Department Occupational Safety and Health Program**—sets the groundwork for a medical surveillance program.

**NFPA® 1582: Standard on Comprehensive Medical Program for Fire Departments**—stipulates that every fire department “shall have an officially designated physician who shall be responsible for guiding, directing and advising the members with regard to their health, fitness and suitability for various duties.”





## Medical Surveillance

Medical surveillance is the ongoing, routine practice of collecting and interpreting health data. **Medical surveillance enables early detection of changes in health status so that potential problems can be prevented, and quality of life can be maintained.** Medical surveillance that is conducted by an employer or local health department is not meant to take the place of good health and safety practices, or serve as a replacement for annual medical exams with a private physician.

If medical surveillance indicates exposure:

- Affected responders should receive appropriate treatment and follow-up
- Department procedures should be reviewed for adequacy
- All costs of testing, treatment and medical follow-ups are incurred by the employer

Fire fighters die all too often from traumatic injuries at emergency scenes. The number of deaths that result from occupational exposures to hazardous materials should decrease, given wider use of in-depth medical surveillance. Illness stemming from exposures can be very subtle and may take years, even decades, to surface. Heart and lung diseases and cancer are a few of the many health conditions now associated with fire fighting and hazardous materials response.

Fire fighter deaths occur most frequently at two distinct time periods during a typical career:

- During the first five years on the job, due to traumatic injury and inexperience
- Between eighteen to thirty years of service, due to heart disease and cancer

## Baseline Physical Assessments

To effectively track your health status, you must have a baseline physical assessment followed by routinely scheduled evaluations. Health assessments are based on a variety of sources. These include:

- Questionnaire data
- Physical examinations
- Diagnostic medical testing
- Biological monitoring



## Periodic Medical Examinations

Hazardous materials responders need to get medical reviews or interval examinations annually so that new medical data can be compared to baseline information, increasing the chance for early detection of any changes in body systems. Changes can indicate a need for further testing or medical treatment. Test results can also substantiate changes needed to improve personal protective equipment or work practices.

These examinations can be performed more frequently if necessary, based on special hazards, exposures, symptoms, age and previous health conditions. Any exposures during the interval since the last exam should be discussed and further exams considered (targeting organs most likely affected by exposures.) Specific exposure information, medical history and results of the physical exam all help determine follow-up testing. For example, liver enzyme testing may be indicated if a first responder has been exposed to large amounts of petroleum-based solvents.

A fire fighter's department generally does not receive details, should a medical problem or disease be detected. When a physician communicates information to the fire department regarding the results of a fire fighter's medical examination, the notification is typically limited to whether the employee:

- Can work
- Can work in a limited capacity
- Cannot work
- Requires further medical evaluation

## Record Keeping

Maintenance of, and access to, your medical records by your employer must be in accordance with federal and state regulations. The procedures set forth in NFPA® 1500 should also be included in department policies. **If you are exposed, OSHA regulations require that your medical records be maintained by your department for thirty years after you leave employment.**

The results of medical tests must be made available to you on request. The employer is only informed about limitations in your work duties, not specific information about medical conditions. Medical surveillance programs are intended to provide confidentiality. If confidentiality cannot be expected, workers may not use medical monitoring to maximum benefit. Without the trust afforded by confidentiality, the program might be severely compromised.





## OSHA 29 CFR 1910.120

### Medical Surveillance Program for Fire Fighters

Fire fighters are entitled to medical surveillance when they:

- ▶ Operate as members of a Hazardous Materials Team.
- ▶ Are exposed to hazardous substances for thirty or more days per year, at or above exposure limits: OSHA permissible exposure limit (PEL).
- ▶ Become injured or suffer an illness due to overexposure from an emergency incident involving hazardous substances.

You should routinely document your own work-related exposures and keep a copy for your records. Medical record keeping needs to involve your employer as well. The employer typically retains:

- Records indicating your name
- The physician's written opinion
- Any employee medical complaint related to exposures
- A copy of information provided to the examining physician by the employer regarding employee exposures

By routinely recording occupational injuries and illnesses, weaknesses in current equipment and department procedures can be pinpointed for improvement.

Some local unions and state associations also keep exposure records. Such documentation can support needed changes and improvements in emergency operations. Documentation also plays a crucial role in diagnosis, treatment and insurance coverage for some medical conditions.



## Exposure Reporting Procedures



Use the space below for your notes.

1. **You have just arrived back at the station from a call that potentially involved hazardous materials. What are three things you would do, and in what order?**

---

---

---

2. **What is important to document?**

---

---

---

---

---



Page left blank intentionally.



## Exposure Report Form

Name:		ID #:	
Incident #:	Date:	Location:	
Circle Incident Type:	Fire 1. Structural 2. Trash/Dumpster 3. Vehicle 4. Marine 5. Wildland	Other 6. EMS 7. HazMat Spill 8. Rescue 9. Fire Station 10. Training Site	Not Listed 11. Other (explain)
Circle Primary Activity Type:	1. Extinguishment 2. Search/Rescue 3. Ventilation 4. Salvage 5. Support 6. Medical Care	7. HazMat Response 8. Vehicle Extraction 9. Command 10. Rehabilitation 11. Undetermined/Not Reported 12. Other (explain):	
Check PPE Worn:	Fire/Rescue <input type="checkbox"/> 1. Helmet <input type="checkbox"/> 2. Coat <input type="checkbox"/> 3. Trousers <input type="checkbox"/> 4. Boots <input type="checkbox"/> 5. Gloves <input type="checkbox"/> 6. Hood <input type="checkbox"/> 7. Eye Protection <input type="checkbox"/> 8. SCBA <input type="checkbox"/> 9. Respirator	EMS <input type="checkbox"/> 1. Gloves: Latex <input type="checkbox"/> 2. Eye Protection <input type="checkbox"/> 3. Mask: HEPA <input type="checkbox"/> 4. Mask: Surgical <input type="checkbox"/> 5. Fluid Resistant Clothing <input type="checkbox"/> Other <input type="checkbox"/> 1. Hearing Protection <input type="checkbox"/> 2. Other (specify):	HazMat <input type="checkbox"/> 1. Level A <input type="checkbox"/> 2. Level B <input type="checkbox"/> 3. Level C <input type="checkbox"/> 4. Level D
Check Area(s) Exposed:		Check Type(s) of Exposure:	
<input type="checkbox"/> 1. Face/Neck <input type="checkbox"/> 2. Hand/Arm/Fingers <input type="checkbox"/> 3. Trunk <input type="checkbox"/> 4. Legs/Foot <input type="checkbox"/> 5. Lungs/Respiratory Track <input type="checkbox"/> 6. Other (explain):		<input type="checkbox"/> 1. Airborne <input type="checkbox"/> 2. Skin Infection <input type="checkbox"/> 3. Blood/Body Fluid Contact <input type="checkbox"/> 3a. Boots <input type="checkbox"/> 3b. Gloves <input type="checkbox"/> 3c. Hood <input type="checkbox"/> 3d. Eye Protection <input type="checkbox"/> 4. Other (explain):	
Check Symptom(s):			
<input type="checkbox"/> 1. None at this time <input type="checkbox"/> 2. Eyes burn <input type="checkbox"/> 3. Cough <input type="checkbox"/> 4. Cuts/Bruises <input type="checkbox"/> 5. Dizziness/Nausea		<input type="checkbox"/> 6. Nose/Throat/Lung Irritation <input type="checkbox"/> 7. Ears ringing <input type="checkbox"/> 8. Headache <input type="checkbox"/> 9. Skin irritation/Rash <input type="checkbox"/> 10. Other (explain):	
Medical Attention Required: <input type="checkbox"/> Yes <input type="checkbox"/> No		Length of Exposure:	
List Specific Toxins:		List Type of Agent (e.g., biological, chemical):	
Signature:			



## NFPA 1500 Standard on Fire Department Occupational Safety and Health Programs



The NFPA® developed **NFPA® 1500 Standard on Fire Department Occupational Safety and Health Programs**. This standard specifically addresses the need for a comprehensive approach to the health and safety of fire fighters and emergency medical care providers.

### How Is My Health Assessed?

To effectively track the status of your health, you must have a baseline physical and assessment followed by routinely scheduled evaluations. Your health assessments are based on a variety of sources. These include:

- Questionnaire data
- Physical examinations
- Diagnostic medical testing
- Biological monitoring

### Questionnaire Data

Questionnaires provide important information regarding your:

- Medical history
- Occupational history
- Family history
- Current symptoms that might be related to hazardous materials exposure



A key component of the questionnaire is determining risk factors. Risk factors are areas that might predispose you to negative health effects. For example, someone with cardiac or respiratory disease history might not be able to wear fully encapsulating chemical protective clothing or self-contained breathing apparatus in strenuous situations.

Other risk factors include:

- Chronic Obstructive Pulmonary Disease (COPD)
- Severe asthma
- Previous heart attack
- Current obesity

In addition to risk factors, questionnaires should also include an area devoted to occupational history. This section looks at current job duties, previous employment and part-time work. This type of information, including non-occupational exposures, (perhaps from hobbies such as car repair) can help to pinpoint areas of potential concern. Previous known exposures to asbestos and solvents such as benzene are other examples.

### Physician's Written Opinion

The physician writes his or her opinion regarding the employee's fitness for duty. Copies of the written opinion must be sent to both the employer and the employee. Medical records regarding specific conditions that the employee may have are confidential, so they must be maintained separate from personnel records.



The opinion must include:

- Results of the medical exam and tests (available to employees only)
- Physician's opinion as to whether the employee has any detected medical conditions that could increase risk of health impairment
- Physician's recommended limitation, if any, on the employee's assigned work
- A statement that the employee has been informed by the physician of the results of the medical exam and any medical conditions that require further exams or treatment
- The written opinion obtained by the employer should not reveal specific findings or limitations unrelated to occupational exposure

### *Types of Physicians*

The physician conducting surveillance exams must be well acquainted with the fire/rescue service and the special needs of hazardous materials emergency responders. Physicians trained in occupational medicine or toxicology are ideally suited to conduct surveillance programs. It is essential that all physicians be familiar with OSHA/EPA requirements and NFPA® standards, as well as common work practices. Physicians must also be aware of, and follow, applicable confidentiality and reporting requirements. This exam should not replace your routine health care follow-up.

### Physical Examinations

There are a variety of medical examinations that may be appropriate during your participation in a comprehensive medical surveillance program. Some of these examinations are routine, and others are specific to known or possible exposures. Knowing the different types can help to ensure that you participate successfully.

Your employer must provide specific information to the health care provider conducting a medical surveillance exam under the OSHA or EPA regulations. If you are being sent to a community hospital or private clinic, this information should be made available in order to help the physician or other provider understand the nature of your work.

This information includes:

- A copy of 29 CFR 1910.120, The Hazardous Waste Operations and Emergency Response Standard
- A description of the employee's duties as they relate to his or her exposure
- The employee's previous exposure levels and anticipated exposure levels
- A description of any personal protective equipment used or to be used
- Information from the employee's previous medical exams that is not readily available to the examining physician

### *Pre-Placement Physical Exams*

A pre-placement exam is given at the time of hiring or change in job duties. It is an important opportunity to gain baseline or initial data for use in future comparisons. It allows the physician to determine if you can safely wear protective equipment while working in a hazardous environment. Pertinent history includes:

- Allergies
- Illnesses
- Risk factors
- Dietary and exercise habits
- Occupational history



Minimal items included in the comprehensive physical examination include:

- Physical evaluation
- Body composition
- Laboratory tests
- Vision tests
- Hearing evaluation
- Pulmonary function test
- EKG
- Cancer screening



OSHA 1910.134, the Respiratory Fit Standard, has a stand alone medical evaluation with which each emergency responder who is expected to wear a full faced positive pressure SCBA must comply. One of the things the physician needs to see is an example of the PPE that the employee would be expected to wear during normal operations.

### *Post-Exposure Monitoring*

Post-exposure monitoring may be necessary even if responders are not experiencing symptoms. Testing may also be required even after medical treatment has been completed. In some cases, depending on the type of exposure, specific tests can be administered to quantify the exposure. These tests can serve as the basis for determining whether additional medical treatment is necessary.

It is very important that all confirmed or suspected exposures be carefully documented in written form. These records are very useful during the annual medical review, and can also be used as claims evidence in applicable workers compensation cases.

These evaluations are designed to assist in the early identification of illness or injury that may be related to the adverse effect of a work site exposure or the working environment. In addition, any employer having workers with occupational exposures to infectious diseases is required to establish a written exposure control plan designed to eliminate or minimize exposures, and to handle them properly when they occur.

### *Exit Physical Examinations*

This examination is performed when you leave your department or transfer to work that does not involve continued exposure to hazardous materials. The purpose of an exit exam is to establish the state of a member's health at the conclusion of a specific job assignment. The components of the exam are similar to those of the periodic exam.

### *Diagnostic Medical Testing*

Diagnostic medical testing evaluates target organs. Diagnostic tests may include:

- Blood tests
- Urinalysis
- Lung function testing
- Electrocardiogram
- Stress tests
- Hearing test







## Biological Monitoring

Biological monitoring measures the level or effects of a specific agent. It is usually done only if you are exposed to an agent for which tests are available, such as:

- Pesticides
- Lead exposure

## Acute Medical Care

There is always a chance that hazardous materials responders will require medical attention as a result of operations at the scene of an emergency. Emergency responders may become injured or ill from exposures or heat stress. It is essential that provisions be made for emergency medical care at the site. Because of the nature of the work, Advanced Life Support should be available to treat and transport responders requiring attention.

As part of your pre-incident planning process, identify hospitals in your area that are equipped to handle chemical and toxicological emergencies. These facilities may have specially trained providers and equipment that could make the difference in an emergency.

## What is Included in an Annual Program Review?

Just like any other program, the medical surveillance component should undergo review to ensure that it is effective. This review, which should occur annually at a minimum, can also help to identify injury trends and special health effects. Review elements should include:

- Assessments of injuries and illnesses to determine the cause. This process allows you to modify health and safety procedures when necessary.
- A review of medical testing for exposures and environmental monitoring to ensure that they are useful.
- An examination of emergency response capabilities and treatment procedures and an updated list of emergency contacts and facilities. Through the on-going planning process, response capabilities should address new hazards and possible exposures.
- A careful analysis of group data to detect trends that may not be apparent through individual results. From these findings, deficiencies in such areas as training or personal protective equipment can be corrected.
- A review of hazardous materials responses, medical records and exposure reports to ensure that responders are receiving proper follow-up care.
- A review of confidentiality procedures and safeguards to ensure that member privacy is protected. An audit of reporting procedures can ensure that only information on work status and restrictions is communicated to management. This element builds trust in the medical surveillance system, and will encourage members to participate fully and completely in the process.



## Proactive Health Strategies

The goal is to remain as healthy as possible through a comprehensive personal program that takes into account physical, emotional and medical needs. If you pay daily attention to these needs, you will reap significant benefits in emergency performance. The benefits of a sustained commitment to well-rounded personal health include:

- Less risk of death or injury or a disabling disease
- Improved physical performance
- Decreased levels of stress, tension and anxiety
- Enhanced ability to rest and sleep
- Better ability to bounce back from strenuous events

Some key components of a proactive health strategy are:

- Medical review
- Fitness
- Stress management
- Nutrition

### Medical Review

An annual medical review helps ensure that emergency responders are well informed about their physical health. A life-long, consistent comparison of essential health data can help detect changes that require follow-up to eliminate the possibility of disease. It is a critical element in a proactive health strategy.

### Fitness

Physical fitness is critical to your overall health and your ability to perform safely and effectively as an emergency responder. Higher levels of aerobic fitness, good flexibility, muscular strength and endurance are key assets in the emergency response profession. All responders participating in fitness programs should be medically cleared prior to doing so. This clearance can establish a health baseline and rule out any existing medical issues that might preclude participating in a fitness program.

- **Aerobic Capacity.** Aerobic capacity is an integral part of a fitness program. Improved aerobic capacity leads to better cardiovascular fitness and keeps blood pressure, weight and body chemistry in the normal ranges. There is little debate that a high aerobic capacity is a prime goal for fire fighters and other emergency responders.
- **Flexibility.** Because emergency response work is physically demanding and often requires intense physical labor in restricted areas, the majority of injuries are sprains and strains. In addition, many fire fighters are forced into retirement each year because of disabling back injuries. An important part of injury prevention is a flexibility program that creates full range of movement for joints and muscles.
- **Muscular Strength and Endurance.** Muscular endurance is defined as the ability of a muscle group to perform work over a period of time sufficient to cause muscle fatigue. Fire fighting and emergency response work frequently requires maximum exertion. Maintaining an appropriate level of muscular strength not only allows you to perform your work efficiently, it establishes a reserve that can prevent sprains and strains. A routine strength-training component is a standard part of responder fitness.

### High Risk Behaviors

#### **Substance abuse:**

The abuse of alcohol is by far the largest concern. An effective program to educate responders and new hires about the problems associated with alcohol and drug abuse is an important part of health promotion. In addition, treatment at reasonable cost should be made available for those who require it.

#### **Tobacco use:**

The use of tobacco in any form is associated with a wide range of negative health effects including heart disease and cancer. Effective programs to stop the use of tobacco are essential.



## Stress Management

To manage stress effectively you must first be aware that you are subject to a variety of stressors. Among these are typical job stress, critical incident stress, stress from financial and legal concerns, family relations and stress from issues such as infectious disease exposure. To manage stress, you need to recognize common symptoms such as loss of appetite, trouble sleeping and anger. Every responder needs to make full use of programs to combat stress.

Such programs include professional counseling, peer support and education. The value of regular exercise as a tool to relieve stress should also be emphasized.

## Nutrition

Proper nutrition is a key part of proactive health maintenance. The daily diet can provide the basic fuel necessary to respond safely and effectively to emergencies. The higher the quality of the fuel you consume, the more effective and efficient you can be. High quality nutrition improves the quality of life and the performance of emergency responders. Some of the positive aspects of a good diet are:

- Increased energy
- Shortened recovery time
- Improved resistance to diseases



To learn more about health and nutrition, explore the IAFF's Menu Planner on the Fit to Survive web site, <http://www.iaff.org/HS/FTS/ftsdefault.asp>.

## Medical Exam Items

### Follow-up or Referral to Health Care Practitioner

The IAFF Wellness-Fitness Initiative (WFI) recognizes the importance of consultation and/or referral to outside health care providers and/or specialists. Aspects of the follow-up and referral program include:

- Abnormal findings on the annual physical must be addressed by follow-up or referral
- Revaccination or intervention following exposures must be managed by follow-up or referral
- Managed care or other provider referrals are appropriate for non-service connected problems
- Return to work determinations require clearance by the fire department physician or other provider following a consult with an outside physician or after extended leave
- Follow-up on findings from annual examinations must be reviewed by the fire department physician



**The health care provider (organization or individual) shall provide written documentation regarding follow-up/referral program or procedures.**



## Individualized Health Risk Appraisal

Written feedback to uniformed personnel concerning health risks and health status is required following the annual examination. Reporting findings and risks and suggesting plans for modifying risks improves the physician-patient relationship and helps uniformed personnel claim ownership of their health status. Individualized health risk appraisals also must include questions that attempt to accurately measure the uniformed personnel's perception of their health. Health perception can be a useful indicator of potential problems.

## Medical History Questionnaire

An initial pre-employment history questionnaire must be completed to provide baseline information with which to compare future medical concerns. A periodic medical history questionnaire must be completed to provide follow-up information. Periodic questionnaires focus on changes in health status.

## Hands-on Physical Examination

Hands-on Physical Examination:

- Vital Signs
- Head, eyes, ears, nose and throat
- Neck
- Cardiovascular
  - Inspection, auscultation, percussion and palpation
- Pulmonary
  - Inspection, auscultation, percussion and palpation
- Gastrointestinal
  - Inspection, auscultation, percussion and palpation
- Genitourinary
  - Hernia exam (also see cancer screening)
- Rectal (see cancer screening)
- Grip strength evaluation
- Curl-up evaluation
- Flexibility evaluation
- Lymph nodes
  - The examination of organ systems must be supplemented with an evaluation of lymph nodes in the cervical, auxiliary and inguinal regions.
- Neurological
  - The neurologic exam for uniformed personnel must include a general mental status evaluation and general assessment of the major cranial/peripheral nerves (motor, sensory, reflexes).
- Musculoskeletal
  - Includes an overall assessment of range of motion (ROM) of all joints. Additionally, observation of the personnel performing certain standard office exercises or functions is helpful in assessing joint mobility and function.





## Body Composition

This evaluation is optional since the accuracy, reliability and practicality of evaluation methods vary. Technical research and data review is continuing, which will allow a future determination to be made regarding the most accurate and consistent method for evaluating body composition of uniformed personnel. For the purposes of this initiative, the international database will not record body composition until such efforts are complete. Fire departments within the WFI will continue to assess body composition using different methods to assist in the research.

## Blood Analysis

The following are components of the blood analysis. At a minimum, laboratory services must provide these components in their automated chemistry panel (aka SMAC 20) and complete blood count (CBC) protocols:

- White Blood Cell Count
- Differential
- Red Blood Cell Count (Hematocrit)
- Platelet Count
- Liver Function Tests
  - Includes SGOT/AST, SGPT/ALT, LDH, Alkaline Phosphatase and Bilirubin
- Triglycerides
- Glucose
- Blood Urea Nitrogen
- Creatinine
- Sodium
- Potassium
- Carbon Dioxide
- Total Protein
- Albumin
- Calcium
- Cholesterol
  - Includes Total Cholesterol, Low Density Lipoprotein (LDL-C) level, High Density Lipoprotein (HDL-C) level and Total Cholesterol/HDL Ratio
- Urinalysis
  - Dip Stick: includes pH, Glucose, Ketones, Protein, Blood and Bilirubin
- Microscopic
  - Includes WBC, RBC, WBC Casts, RBC Casts and Crystals

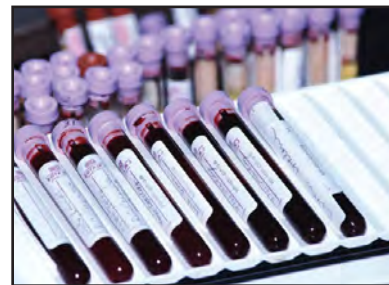

## Heavy Metal and Special Exposure Screening

Baseline testing for heavy metals may be assessed on the initial physical, but is not required under the WFI since the utility of such testing has not been medically established. However, evaluations are required to be done under special circumstances, such as following a known exposure, for recurrent exposures, or where required under federal, state or provincial regulations (e.g., OSHA standards).

- |                   |                         |                   |
|-------------------|-------------------------|-------------------|
| • Arsenic (urine) | • Cadmium               | • Polychlorinated |
| • Mercury (urine) | • Chromium              | Biphenyls (blood) |
| • Lead (urine)    | • Copper                |                   |
| • Lead (blood)    | • Nickel                |                   |
| • Aluminum        | • Zinc                  |                   |
| • Antimony        | • Organophosphates (RBC |                   |
| • Bismuth         | cholinesterase)         |                   |





## Vision Tests

Assessment of vision must include evaluation of distance, near, peripheral and color vision. Evaluate for common visual disorders including cataracts, macular degeneration, glaucoma and diabetic retinopathy.

## Hearing (Audiogram)

## Pulmonary (Spirogram)

## Chest-X-Ray

- Initial Baseline
- Repeat Chest X-Ray (every three years – optional)
- Repeat Chest X-Ray (every five years – mandatory)



## EKG (Resting)

## Cancer Screening Elements

- Clinical Breast Examination
- Mammogram
  - Annual, beginning at age 40
- Pap Smear
- Prostate Specific Antigen
  - Annual on all male uniformed personnel who have a positive family history of prostate cancer or are African-Americans beginning at age 40. All male uniformed personnel beginning at age 50.
- Digital Rectal Exam
- Fecal Occult Blood Testing
- Skin Exam
- Testicular Exam

## Immunizations and Infectious Disease Screening

- Tuberculosis Screen (Mandatory annual PPD)
- Hepatitis B Virus Vaccine (Mandatory)
- Hepatitis C Virus Screen (Baseline)
- Tetanus/Diphtheria Vaccine (Booster every 10 years)
- Measles, Mumps, Rubella Vaccine (MMR)
  - Vaccine is required for all uniformed personnel born in or after 1957 if there is no medical contraindication and no evidence of at least one dose of live vaccine on or after one's first birthday.
- Mumps Vaccine
  - Vaccine is required for all uniformed personnel born in or after 1957 if there is no documentation of physician-diagnosed mumps, no adequate immunization with live mumps after one's first birthday and no evidence of laboratory immunity.
- Rubella Vaccine
  - Vaccine is required unless proof of immunity is available.



- Polio Vaccine
  - Vaccine shall be given to uniformed personnel if vaccination or disease is not documented.
- Hepatitis A Vaccine
  - Vaccine shall be offered to high risk (HazMat, USAR and SCUBA) and other uniformed personnel with frequent or expected frequent contaminated water exposures.
- Varicella Vaccine (Required to be offered)
- Influenza Vaccine (Required to be offered)
- HIV Screening (Required to be offered)

HIV testing should be offered on a confidential basis as part of post-exposure protocols, and as requested by the physician and patient.

### Annual Fitness Evaluation

- Aerobic Capacity
  - Gerkin Protocol (Treadmill)
  - FDNY Protocol (Stairmill)
  - Maximal cardiopulmonary test with EKG
- Push-up Evaluation
- Leg Strength Evaluation
- Arm Strength Evaluation
- Grip Strength Evaluation
- Curl-up Evaluation
- Flexibility Evaluation







Page left blank intentionally.



## Lesson 1.3 - APIE: A Risk-Based Response Process

### Lesson Objectives

After completing this lesson, you will be able to describe the steps, goals and tasks of the APIE: Risk-Based Response Process:



- Analyze the problem
  - Identify the problem and behavior of hazardous materials.
- Plan the response
  - Develop and communicate an incident action plan.
- Implement the plan
  - Observe operations and outcomes.
- Evaluate the progress
  - Assess response effectiveness.





## APIE: A Risk-Based Response Model

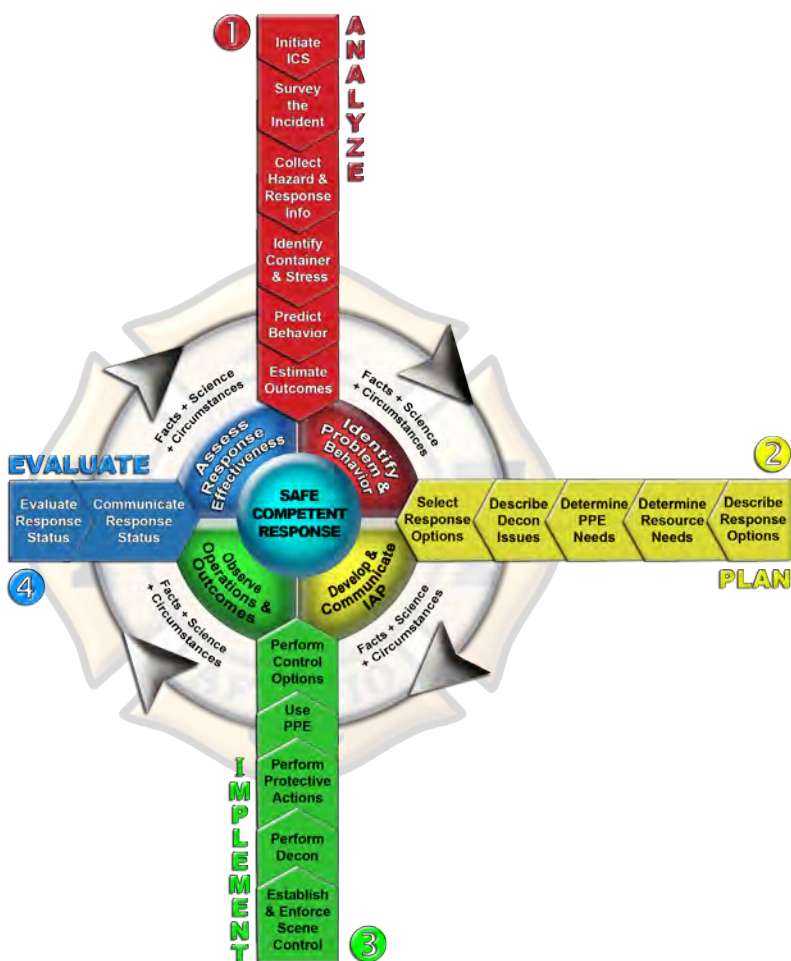

NFPA® defines risk-based response as a “systematic process by which responders analyze a problem involving hazardous materials/weapons of mass destruction (WMD), assess the hazards, evaluate the potential consequences, and determine appropriate response actions based upon facts, science, and circumstances of the incident.” The Federal Emergency Management Agency (FEMA) states that “by following a set of logical steps that includes gathering and analyzing information, determining operational objectives, and developing alternative ways to achieve the objectives, planning allows a jurisdiction or regional response structure to work through complex situations.”<sup>1</sup>

APIE: A Risked-Based Response Process is a logical, analytical, problem-solving process that can be applied to any type of emergency. The goal of APIE: A Risk-Based Response Process is **safe, competent response** aimed at mitigating emergencies while minimizing hazards that can result in exposure, injury and fatalities. Responders should consider the facts, science and the circumstances at each step, and take actions or make decisions based on risk-benefit analysis.

<sup>1</sup> Developing and Maintaining State, Territorial, Tribal and Local Government Emergency Plans, page 1-1, [http://www.fema.gov/pdf/about/divisions/npd/cpg\\_101\\_layout.pdf](http://www.fema.gov/pdf/about/divisions/npd/cpg_101_layout.pdf) (retrieved December 15, 2010).



When you use the APIE process, you begin by analyzing the situation, with the goal of identifying the problem and the likely behavior of the hazardous materials/WMDs and containers present. For the remainder of this course, you will **ANALYZE** clues that indicate when and where hazardous materials/WMDs may be present at an incident.

With practice interpreting and predicting how chemicals might act, you will become increasingly proficient in identifying the exact cause of a problem, and then relating the cause to the type of harm that could result as a consequence. This course teaches you how to make those connections and quickly draw conclusions that will protect lives of both responders and civilians, property and the environment.

The types of harm that can result from a hazardous materials/WMD incident and the routes of entry of a toxic material must be taken into consideration. As you will learn, hazardous materials/WMDs can enter through inhalation, ingestion, injection or absorption. This dictates the appropriate type of personal protective equipment (PPE) required for your protection. Typical fire fighter protective clothing does not provide sufficient protection to guard against most chemicals, so at times your plan to improve the emergency situation will include seeking additional resources.

The goal of the **PLAN** the response step is to develop an incident action plan (IAP) that identifies the incident priorities and objectives, and communicate the IAP to responders. The IAP is communicated using the normal chain of command established by the incident command system (ICS), as well as through a safety briefing prior to entry or operations. Locally developed forms should be used to document IAP information.

Once you know that available responders are trained for the tasks they will perform, prepared for the hazards present, and appropriately equipped, you will be ready to **IMPLEMENT** the planned response actions to stabilize the incident. During implementation, the goal is to observe operations and outcomes.

Hazardous materials/WMD incidents are dynamic, so the tactics may need to be adjusted according to ongoing **EVALUATION** of the progress. The goal of evaluation is to assess response effectiveness. The evaluation process is always critical. If the incident is not stabilizing, or is increasing in intensity, the plan's strategy and tactics may have to be changed to prevent additional harm to life, property and the environment.

**The APIE process is not necessarily linear; any or all steps may need to be repeated. The process is systematic but does not always progress in clear-cut, linear steps. Rather, the steps often overlap and occur simultaneously.** For example, the analysis and planning steps may merge; the implementation and evaluation steps may need to be repeated.

At hazardous materials/WMD incidents, first responders may or may not perform all of the tasks in the APIE process. For example, based on research in the Emergency Response Guidebook (ERG), first responders may request additional resources such as hazardous materials teams with technicians who will perform further, more technical research and mitigation.

**APIE: A Risk-Based Response Process** has four steps to help you work through an incident.

**A**nalyze the problem

**P**lan the response

**I**mplement the plan

**E**valuate the progress

At hazardous materials/WMD incidents, first responders may or may not perform all of the tasks in the APIE process. For example, based on research in the Emergency Response Guidebook (ERG), emergency responders may request additional resources such as hazardous materials teams with technicians who will perform further, more technical research.



Page left blank intentionally.



## Module 2 - Analyze the Problem

### Lesson 2.1 - Recognizing Hazardous Materials

#### Lesson Objectives

**NFPA® 472, 4.2.1<sup>1</sup>**

Identify those situations where hazmat/WMDs are present.



- (1) Identify the definitions of both hazardous material and WMD.
- (5) Identify typical occupancies and locations where hazmat/WMDs are manufactured, transported, stored, used or disposed of.



<sup>1</sup> NFPA 472® Standard for Competence of Responders to Hazardous Materials/Weapons of Mass Destruction, 2013 Edition.



### A Simple Definition

Hazardous materials or dangerous goods are substances which may be in one of the following states:

- ▶ Solid
- ▶ Liquid
- ▶ Gaseous
- ▶ Energy

And, have dangerous capabilities when released.

## Hazardous Materials Defined

### The United States Department of Transportation



United States Department of Transportation (DOT) defines hazardous materials as a substance or material that the Secretary of Transportation has determined is **capable of posing an unreasonable risk to health, safety, and property when transported in commerce**, and has designated as hazardous under section 5103 of Federal hazardous materials transportation law (49 U.S.C. 5103). The term includes hazardous substances, hazardous wastes, marine pollutants, elevated temperature materials, materials designated as hazardous in the Hazardous Materials Table (see 49 CFR 172.101), and materials that meet the defining criteria for hazard classes and divisions in part 173 of subchapter C of 49 CFR.<sup>1</sup>

### Transport Canada<sup>2</sup>



In Canada, the term dangerous goods is used for hazardous materials. Transport Canada considers dangerous goods to be products that are inherently dangerous whether or not they are in transport. Special precautions are called for to ensure their safe transportation. The Transport Dangerous Goods (TDG) Act, 1992, defines the term dangerous goods as follows:

*...means a **product, substance or organism included by its nature or by the regulations in any of the classes listed in the schedule***

The schedule referred to is the Schedule to the TDG Act, 1992, which identifies nine classes of dangerous goods.



### NFPA® 472, 3.3.29: Hazardous Material

NFPA® defines a hazardous material as a substance (either matter—solid, liquid or gas—or energy) that, when released, is capable of creating harm to people, the environment and property including weapons of mass destruction (WMD) as defined in 18 United States Code, Section 2332a, as well as any other criminal use of hazardous materials such as illicit labs, environmental crimes or industrial sabotage.

### NFPA® 472, Annex F.2.7: Dangerous Goods

NFPA® provides the following regarding dangerous goods. In the United Nations model codes, and regulations, hazardous materials are called dangerous goods.

<sup>1</sup> 49 CFR 171.8

<sup>2</sup> Transport Dangerous Goods Primer, [http://www.tc.gc.ca/eng/tdg/publications-primer\\_e-263.htm](http://www.tc.gc.ca/eng/tdg/publications-primer_e-263.htm), retrieved May 17, 2013.





## Clues for Recognizing Hazardous Materials

**Every incident should be assumed to involve hazardous materials until, and unless, proven otherwise. As soon as the clues prove that hazardous materials or WMDs are not present, the response can proceed as routine.**

Certain signs indicate the possible presence of hazardous materials at an emergency scene. Emergency responders use these signs to identify and characterize the specific chemical involved, and to subsequently plan appropriate response actions. Clues to help determine the presence of hazardous materials include:

- Clue #1: Dispatch Information
- Clue #2: Occupancy and Location
- Clue #3: Container Shape and Design
- Clue #4: Placards, Labels and other Markings
- Clue #5: Shipping Papers and Facility Documents

These clues can singularly or jointly:

- Help narrow the possibilities
- Corroborate other evidence
- Predict chemical reactions
- Instruct appropriate actions
- Expedite emergency response

Notice that the clues are specifically ordered to allow you to begin your analysis from a safe distance—while en route to the incident you can analyze the dispatch information and determine the type of occupancy and location. Upon arrival, and before approaching the scene, you can look for the containers involved, as well as the placards, labels and other markings. Finally, if you cannot identify the material, you may need to obtain the shipping papers or facility documents.

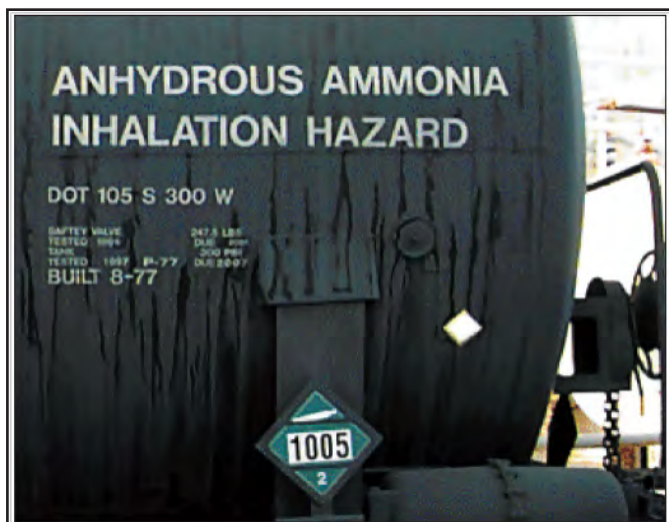

### Clues Found at Chemical Facilities

- ▶ Low-lying vapor clouds
- ▶ Visible corrosion on containers
- ▶ Chemical reactions
- ▶ Hissing sounds from valves

What clues can you find in this photograph?



## Dispatch Information

Whoever discovers a hazardous materials/WMD incident unfolding typically reacts by calling for help. They usually phone 9-1-1. The call taker at the dispatch center asks for an incident description. The caller's description will range from very detailed to somewhat vague, depending on their ability to recall and convey pertinent, complete information.

Emergency dispatchers normally ask callers what type of material is involved, what type of leak is occurring, and whether fire is involved. They request information such as the name of the building or company; call back numbers; and whether anyone is injured, exposed, or unaccounted for. Some newer dispatch systems automatically send information out to fire fighters (which may even include wind speed and direction). However, even with the newer dispatch systems, the amount of information relayed to the fire station's alert system may be limited.

When incomplete information is received, responders should request specific details to help analyze the situation and plan an appropriate response. If necessary, request:

- The name of the product involved (or at least its UN number, type of placard, size or type of container)
- What kinds of injuries and how many victims are involved
- The location, and whether the problem is inside or outside of a particular building
- What actions are currently being taken at the scene

Dispatch information can provide a key piece of the recognition and identification puzzle. On the way to the scene, consider the information provided by the caller or dispatcher. Were there any indications that hazardous materials might be involved (e.g., report of a suspicious odor, odd color of smoke, hissing sound, a victim collapsed in a confined space)?

Time spent en route to an emergency can also be used to look up UN numbers and other needed product information, and to check the ERG guide pages for directions on appropriate actions to take in order to safely respond to incidents involving hazardous materials.

As you approach the scene, use your detective abilities to recognize other clues or pieces of evidence signaling the potential presence of hazardous materials. Beginning this analysis process before entering the scene saves time and effort in the long run.



## Occupancy and Location

The occupancy and location of an emergency site can provide valuable clues regarding the potential for hazardous material/WMD involvement.

If the processes, materials used, or products manufactured at a particular site are known to be hazardous materials, first responders can begin to speculate about the hazards that might be present.

Hazardous materials incidents are not confined to industrial settings. A shopping center, dry cleaning facility, hardware store or automobile repair shop could also be the site of a leak, spill or fire involving hazardous materials.

Often, the people who use these materials are not aware of the potential hazards unless they work with the fire department to prepare in advance for an emergency situation. Later in this course, you will learn how to use pre-incident planning as a preventative measure before problems arise, and as a means of educating yourself and the public about the safe use and storage of hazardous materials in the local community.



Loading rack for petroleum at bulk storage tank farm (low pressure product cargo tank)



Virtually any industry or business can store or use hazardous materials.



## Hazardous Materials Locations

Fire fighters should expect hazardous materials anywhere, because they are, in fact, present at virtually every call. Emergencies involving hazardous materials can occur at various locations:

- Residences and other buildings or structures
- Commercial fixed sites
- Transportation routes
- Non-structural/outside locations

**Residences** account for the majority of all structural fires. You may not consider residences as potential sites for hazardous materials. While it is true that most homeowners do not store large quantities of hazardous materials, they generally possess small amounts of many hazardous substances (such as pesticides). In addition, even routine fires at residences will produce a variety of toxic chemicals. Carbon, for example, is produced at all fires; frequent exposure to carbon (present in soot) is highly correlated to cancer.

**Give examples of hazardous materials in residences.**

**Fixed sites** include structures housing businesses such as medical and research facilities, manufacturing and agricultural centers. Often the nature of the site itself can indicate the presence of hazardous materials. (For example, a plant named ACME Chemical Company probably houses potential hazards.) Always assume hazardous materials are present, no matter what type of structure is involved in an emergency incident.

**Give examples of commercial fixed sites in your jurisdiction that use or store hazardous materials.**

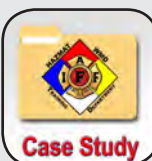

Hazardous materials can adversely affect many people in a very short time period. For example, an accidental leak of anhydrous ammonia at a Honeywell refrigeration plant in Baton Rouge, Louisiana sent four workers to the hospital and forced 600 residents to stay indoors (shelter-in-place).



**Transport** of hazardous materials increases their danger. Cargo tankers frequent the highways. They are constructed of thin, weight-saving materials and often transport highly flammable fuels.

Although railway accidents occur less frequently than those on the highway, major catastrophes can evolve because trains typically include many cars and different types of hazardous materials.

**Give examples of transportation corridors for hazardous materials in your jurisdiction.**

The table below shows the number of hazardous materials incidents by transportation mode in the United States for 2011, 2012 and the first half of 2013.\*

Transport Mode	2011	2012	2013*
Air	1,410	1,460	547
Highway	12,810	13,225	5,417
Railway	745	662	266
Water	71	70	29
<b>TOTAL</b>	<b>15,036</b>	<b>15,417</b>	<b>6,259</b>

The table below shows the number of hazardous materials incidents by transportation phase in United States for 2011, 2012 and the first half of 2013.\*

Transport Phase	2011	2012	2013*
In transit	3,889	4,085	1,692
In transit storage	565	573	197
Loading	2,858	3,062	1,178
Unloading	7,714	7,697	3,192
<b>TOTAL</b>	<b>15,026</b>	<b>15,417</b>	<b>6,259</b>





**Other non-structural /outside locations** that contain or transport hazardous materials include petroleum pipelines, electrical transformers, landfills and other waste disposal sites.

**Give examples of hazardous materials in other locations.**



Because of their mixed loads, dumpster fires may be among the most hazardous of routine fire responses.













## UN/DOT Hazard Classes and Divisions

The United Nations (UN), Department of Transportation (DOT) and Transport Canada (TC) have divided hazardous materials into nine (9) hazard classes. Each of the hazard classes may be further divided into divisions.

You can use the mnemonic, “Every Good Lieutenant’s Standard Operating Procedure Requires Constant Monitoring” as shown below to remember the names of the hazard classes.

Class 1 - <b>E</b> xplosives	→	<b>E</b> very	→	
Class 2 - <b>G</b> ases	→	<b>G</b> ood	→	
Class 3 - <b>L</b> iquids	→	<b>L</b> ieutenant’s	→	
Class 4 - <b>S</b> olids	→	<b>S</b> tandard	→	
Class 5 - <b>O</b> xidizers	→	<b>O</b> perating	→	
Class 6 - <b>P</b> oisons	→	<b>P</b> rocedure	→	
Class 7 - <b>R</b> adiological	→	<b>R</b> equires	→	
Class 8 - <b>C</b> orrosives	→	<b>C</b> onstant	→	
Class 9 - <b>M</b> iscellaneous	→	<b>M</b> onitoring	→	

You’ll learn more about the hazard classes in the next lesson.





## Key Points

When examining the data for hazard classes and divisions involved in hazmat incidents for all modes of transportation, note that:

- ▶ Over half (50%) of the incidents involved flammable/combustible liquids.
- ▶ About one quarter (25%) of the incidents involved corrosive materials.

Texas, California and Illinois had the highest number of hazmat incidents within the United States—over 1,000 incidents per year.

The top causes of hazardous materials incidents are:

1. Loose closure, component or device
2. Cause not reported
3. Human error
4. Dropped
5. Improper preparation for transportation
6. Forklift accidents
7. Inadequate blocking and bracing
8. Defective component or device
9. Impact with sharp or protruding object (e.g., nails)
10. Too much weight on package

The table below shows the number of incidents by hazard division in the United States for 2011, 2012 and the first half of 2013.

Hazard Class and Division	2011	2012	2013*
1.1: Explosive Mass Explosion Hazard	2	3	1
1.3: Explosive Fire Hazard	2	1	0
1.4: Explosive No Blast Hazard	32	30	17
1.5: Very Insensitive Explosive	1	4	0
2.1: Flammable Gas	343	428	209
2.2: Nonflammable Compressed Gas	589	442	176
2.3: Poisonous Gas	34	34	7
3: Flammable Combustible Liquid	7,355	7,983	3,384
4.1: Flammable Solid	76	72	37
4.2: Spontaneous Combustion	8	5	3
4.3: Dangerous When Wet	6	7	4
4.4 Flammable Solid (Pre 1991)	3	0	0
5.1: Oxidizer	485	563	290
5.2: Organic Peroxide	136	148	48
6.1: Poisonous Materials	288	322	123
6.2: Infectious Substance (Etiologic)	53	36	13
7: Radioactive Material	8	19	6
8: Corrosive Material	3,724	3,887	1,560
9: Miscellaneous Hazardous Material	637	711	320
Combustible Liquid	1,120	588	15
Other Regulated Material, Class D	154	170	63
<b>TOTAL</b>			

The table below shows the ten states in the United States with the highest rates of hazardous materials incidents during the first half of 2013. The table also shows the data for those states in 2011 and 2012.

State	2011	2012	2013*
Texas	1,476	1,408	575
California	1,314	1,272	571
Illinois	1,153	1,157	472
Ohio	835	954	396
Pennsylvania	740	785	305
Tennessee	695	754	304
Florida	619	686	273
Georgia	451	519	236
New York	468	404	216
Indiana	419	475	177

Source: Hazmat Intelligence Portal, United States, Department of Transportation, Pipeline and Hazardous Materials Safety Administration, Incident Statistics <http://phmsa.dot.gov/hazmat/library/data-stats/incidents> (\* Data as of 7/19/2013)



## Predicting Hazards

Use the space below for your notes.



Potential Hazards by Location
Construction sites:
Trenches, tanks or other confined spaces:
Residential fires:
Commercial buildings:
Trash, garbage or other wastes (as well as unknown materials):
Electrical transformers:
Cargo tanks/Rail cars:



Page left blank intentionally.



## Lesson 2.2 - Placards, Labels and Markings

### Lesson Objectives<sup>1</sup>



#### NFPA® 472, 4.2.1

- (2) Identify the UN/DOT hazard classes and divisions of hazmats/WMDs and identify common examples of materials in each hazard class or division.
- (3) Identify the primary hazards associated with each UN/DOT hazard class and division.
- (7) Identify facility and transportation markings and colors that indicate hazmats/WMDs are present (a-d, f).
- (8) Given an NFPA 704 marking, describe the significance of the colors, numbers and special symbols.
- (9) Identify United States and Canadian placards and labels that indicate hazmats/WMDs.

#### NFPA® 472, 4.2.2

- (2) Identify sources for obtaining the names of, UN/NA identification numbers for, or types of placards associated with hazmats/WMDs in transportation.
- (3) Identify sources for obtaining the names of hazmats/WMDs at a facility.

#### NFPA® 472, 5.2.1.2.2

Identify the markings indicating container size, product contained and/or site identification numbers.

#### NFPA® 472, 5.2.1.3

Identify the name(s) of hazmat(s) in pipelines, pesticide containers and radioactive packaging.

#### NFPA® 472, 5.2.1.3.2

Identify the hazard information on a pesticide label, then match the information to its significance in surveying hazmat incidents.

#### NFPA® 472, 5.2.1.3.3

Identify the type or category on a radioactive label, contents, activity, transport index and criticality safety index, as applicable.



<sup>1</sup> NFPA 472® Standard for Competence of Responders to Hazardous Materials/Weapons of Mass Destruction, 2013 Edition.



**NFPA® 472, 5.2.2(1)**

Match the definitions associated with the UN/DOT hazard classes and divisions of hazmats/WMDs, including refrigerated liquefied gases and cryogenic liquids, with the class or division.



## Placards, Labels and Markings

**Product labeling provides an extremely valuable clue in hazardous materials identification.** Locations housing hazardous material and their storage containers are often required to be labeled according to product type and hazard potential.

For materials being transported, regulations are specific regarding what materials get classified as hazardous, how they may be shipped, and under what circumstances they should be labeled with identifying placards.

The most common placarding and labeling systems, DOT and NFPA®, are discussed in this section, along with information on descriptive labeling of pesticides.



Placards are required on back, front and both sides of highway containers.



DOT markings may provide the initial and most valuable clue regarding any hazmats onboard.





U.S. Department  
of Transportation  
Pipeline and  
Hazardous Materials  
Safety Administration

# DOT CHART 15

## Hazardous Materials Markings, Labeling and Placarding Guide

Refer to 49 CFR, Part 172:

Marking - Subpart D

Labeling - Subpart E

Placarding - Subpart F



**NOTE:** This document is for general guidance only and should not be used to determine compliance with 49 CFR, Parts 100-185.

### HAZARDOUS MATERIALS MARKINGS

Package Orientation  
(Red or Black)



§172.312(a)

Keep Away from Heat



§172.317

Fumigant Marking  
(Red or Black)



§173.25(a)(4)



§172.302(g) and §173.9



§172.313(a)

Biological Substances,  
Category B

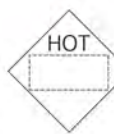

§172.325

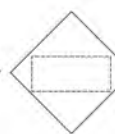

§172.332(a)

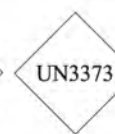

§173.199 (a)(5)

Limited Quantity\*



§172.315

ORM-D, Transition  
December 31, 2020



§172.316



Excepted Quantity



§173.4a(g)

Marking of IBCs

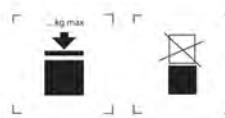

§178.703(b)(7)(i)

Marine Pollutant



§172.322

\* The new limited quantity marking designates hazardous material packages prepared for air transport (Y) and packages not prepared for air transport (all other modes). The ORM-D classification and the use of packagings marked "Consumer commodity, ORM-D" is authorized until December 31, 2020, for domestic highway, rail, and vessel transportation. Transitional exception—Square-on-point with Identification Number: except for transportation by aircraft and until December 31, 2014, a package containing a limited quantity may be marked with identification number, preceded by the letters "UN" or "NA".





# Hazardous Materials Warning Labels

Actual label size: at least 100 mm (3.9 inches) on all sides

**CLASS 1 Explosives:**  
 Divisions 1.1, 1.2, 1.3, 1.4, 1.5, 1.6



§172.411

\* Include compatibility group letter.

\*\* Include division number and compatibility group letter.

**CLASS 2 Gases:**  
 Divisions 2.1, 2.2, 2.3



§172.405(b), §172.415, §172.416, §172.417

**CLASS 3 Flammable Liquid**



§172.419

**CLASS 4 Flammable Solid, Spontaneously Combustible, and Dangerous When Wet:**  
 Divisions 4.1, 4.2, 4.3



§172.420, §172.422, §172.423

**CLASS 5 Oxidizer, Organic Peroxide:** Divisions 5.1 and 5.2



§172.426, §172.427

**CLASS 6 Poison (Toxic), Poison Inhalation Hazard, Infectious Substance:** Divisions 6.1 and 6.2



§172.323, §172.405(c), §172.429, §172.430, §172.432

For Regulated Medical Waste (RMW), an Infectious Substance label is not required on an outer packaging if the OSHA Biohazard marking is used as prescribed in 29 CFR 1910.1030(g). A bulk package of RMW must display a BIOHAZARD marking.

**CLASS 7 Radioactive**



§172.436, §172.438, §172.440, §172.441

**CLASS 8 Corrosive**



§172.442

**CLASS 9 Miscellaneous Hazardous Material**

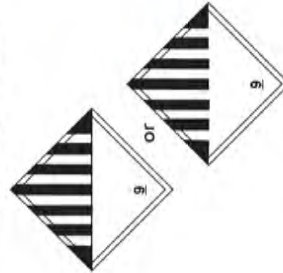

§172.446



§172.448

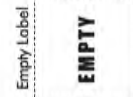

§172.450



# Hazardous Materials Warning Placards

Actual placard size: at least 250 mm (9.84 inches) on all sides

<p><b>CLASS 1 Explosives</b></p> <p>§172.522 §172.523 §172.524 §172.525</p> <p>* For Divisions 1.1, 1.2, or 1.3, enter division number and compatibility group letter, when required; placard any quantity. For Divisions 1.4, 1.5, and 1.6, enter compatibility group letter, when required; placard 454 kg (1,001 lbs) or more.</p>	<p><b>CLASS 2 Gases</b></p> <p>§172.528 §172.530 §172.532 §172.540</p> <p>For NON-FLAMMABLE GAS, OXYGEN (compressed gas or refrigerated liquid), and FLAMMABLE GAS; placard 454 kg (1,001 lbs) or more gross weight. For POISON GAS (Division 2.3), placard any quantity.</p>	<p><b>CLASS 3 Flammable Liquid and Combustible Liquid</b></p> <p>§172.542 §172.544</p> <p>For FLAMMABLE, placard 454 kg (1,001 lbs) or more. GASOLINE may be used in place of FLAMMABLE placard displayed on a cargo tank or portable tank transporting gasoline by highway. Placard combustible liquid transported in bulk. See §172.504(f)(2) for use of FLAMMABLE placard in place of COMBUSTIBLE. FUEL OIL may be used in place of COMBUSTIBLE on a cargo or portable tank transporting fuel oil not classed as a flammable liquid by highway.</p>	<p><b>CLASS 4 Flammable Solid, Spontaneously Combustible, and Dangerous When Wet</b></p> <p>§172.546, §172.547, §172.548</p> <p>For FLAMMABLE SOLID and SPONTANEOUSLY COMBUSTIBLE, placard 454 kg (1,001 lbs) or more. For DANGEROUS WHEN WET (Division 4.3), placard any quantity.</p>	<p><b>CLASS 5 Oxidizer &amp; Organic Peroxide</b></p> <p>Organic Peroxide, Transition-2011 (rail, vessel, and aircraft) 2014 (highway)</p> <p>§172.550, §172.552</p> <p>For OXIDIZER and ORGANIC PEROXIDE (other than TYPE B, temperature controlled), placard 454 kg (1,001 lbs) or more. For ORGANIC PEROXIDE (Division 5.2), Type B, temperature controlled, placard any quantity.</p>	<p><b>CLASS 6 Poison (Toxic) and Poison Inhalation Hazard</b></p> <p>§172.504(f)(10), §172.554, §172.555</p> <p>For POISON (PGI or PGI), other than inhalation hazard) and POISON (PGIII), placard 454 kg (1,001 lbs) or more. For POISON-INHALATION HAZARD (Division 6.1), inhalation hazard only, placard any quantity.</p>	<p><b>CLASS 7 Radioactive</b></p> <p>§172.556</p> <p>Placard any quantity - packages bearing RADIOACTIVE YELLOW-III labels only. Certain low specific activity radioactive materials in "exclusive use" will not bear the label, but the radioactive placard is required for exclusive use shipments of low specific activity material and surface contaminated objects transported in accordance with §172.504(e) Table 1 and §173.427(e)(6).</p>	<p><b>CLASS 8 Corrosive</b></p> <p>§172.558</p> <p>For CORROSIVE, placard 454 kg (1,001 lbs) or more.</p>	<p><b>CLASS 9 Miscellaneous</b></p> <p>§172.560</p> <p>Not required for domestic transportation. A bulk packaging containing a Class 9 material must be marked with the appropriate ID number displayed on a Class 9 placard, on orange panel, or a white square-on-point display.</p>	<p><b>CLASS 9 Miscellaneous</b></p> <p>§172.521</p> <p>A freight container, unit load device, transport vehicle, or rail car which contains non-bulk packages with two or more categories of hazardous materials that require different placards specified in Table 2 §172.504(e) may be placarded with DANGEROUS placards instead of the specific placards required for each of the materials in Table 2. However, when 1,000 kg (2,205 lbs) or more of one category of material is loaded at one loading facility, the placard specified in Table 2 must be applied.</p>	<p><b>Dangerous</b></p> <p>§172.315(o)(2) (Vessel transport only).</p>	<p><b>Limited Quantity Marking</b></p>
---	---	--	---	---	---	--	---	--	--	--	--

Safety begins with communication!





## General Guidelines on Use of Warning Labels and Placards

### LABELS

See 49 CFR, Part 172, Subpart E, for complete labeling regulations.

- The Hazardous Materials Table [§172.101, Col. 6] identifies the proper label(s) for the hazardous material listed.
- Any person who offers a hazardous material for transportation **MUST** label the package, if required [§172.400(a)].
- Labels may be affixed to packages when not required by regulations, provided each label represents a hazard of the material contained in the package [§172.401].
- For labeling mixed or consolidated packages, see §172.404.
- The appropriate hazard class or division number must be displayed in the lower corner of a primary and subsidiary hazard label [§172.402(b)].
- For classes 1,2,3,4,5,6, and 8, text indicating a hazard (e.g., "CORROSIVE") is **NOT** required on a primary or subsidiary label. The label must otherwise conform to Subpart E of Part 172 [§172.405].
- Labels must be printed on or affixed to the surface of the package near the proper shipping name marking [§172.406(a)].
- When primary and subsidiary labels are required, they must be displayed next to each other [§172.406(c)].
- For a package containing a Division 6.1, PG III material, the POISON label specified in §172.430 may be modified to display the text PG III instead of POISON or TOXIC. Also see §172.405(c).
- The ORGANIC PEROXIDE label [§172.427] indicates that organic peroxides are highly flammable. Use of the ORGANIC PEROXIDE label eliminates the need for a flammable liquid subsidiary label. The color of the border must be black and the color of the flame may be black or white.

### PLACARDS

See 49 CFR, Part 172, Subpart F, for complete placarding regulations.

- Each person who offers for transportation or transports any hazardous material subject to the Hazardous Materials Regulations must comply with all applicable requirements of Subpart F [§172.500].
- Placards may be displayed for a hazardous material, even when not required, if the placarding otherwise conforms to the requirements of Subpart F of Part 172 [§172.502(c)].
- For other than Class 7 or the DANGEROUS placard, text indicating a hazard (e.g., "FLAMMABLE") is not required. Text may be omitted from the OXYGEN placard only if the specific ID number is displayed on the placard [§172.519(b)(3)].
- For a placard corresponding to the primary or subsidiary hazard class of a material, the hazard class or division number must be displayed in the lower corner of the placard [§172.519(b)(4)].
- Except as otherwise provided, any bulk packaging, freight container, unit load device, transport vehicle or rail car containing any quantity of material listed in Table 1 must be placarded [§172.504].
- When the aggregate gross weight of all hazardous materials in non-bulk packages covered in Table 2 is less than 454 kg (1,001 lbs), no placard is required on a transport vehicle or freight container when transported by highway or rail [§172.504(c)].
- Notes: See §172.504(f)(10) for placarding Division 6.1, PG III materials.
- Placarded loads require registration with USDOT. See §107.601 for registration regulations.
- The new ORGANIC PEROXIDE placard became mandatory 1 January 2011 for transportation by rail, vessel, or aircraft and becomes mandatory 1 January 2014 for transportation by highway. The placard will enable transport workers to readily distinguish peroxides from oxidizers [§172.552].

## PLACARDING TABLES

[§172.504(e)]

TABLE 1

Category of material (Hazard Class or division number and additional description, as appropriate)	Placard name
1.1.....	EXPLOSIVES 1.1.....
1.2.....	EXPLOSIVES 1.2.....
1.3.....	EXPLOSIVES 1.3.....
2.3.....	POISON GAS.....
4.3.....	DANGEROUS WHEN WET.....
5.2 (Organic peroxide, Type B, liquid or solid, temperature controlled).....	ORGANIC PEROXIDE.....
6.1 (Materials poisonous by inhalation (see §171.8)).....	POISON INHALATION HAZARD.....
7 (Radioactive Yellow III label only).....	RADIOACTIVE <sup>1</sup> .....

<sup>1</sup>RADIOACTIVE placard also required for exclusive use shipments of low specific activity material and surface contaminated objects transported in accordance with §173.427(b)(4) and (5) or (c) of the subchapter.

TABLE 2

Category of material (Hazard Class or division number and additional description, as appropriate)	Placard name
1.4.....	EXPLOSIVES 1.4.....
1.5.....	EXPLOSIVES 1.5.....
1.6.....	EXPLOSIVES 1.6.....
2.1.....	FLAMMABLE GAS.....
2.2.....	NON-FLAMMABLE GAS.....
3.....	FLAMMABLE.....
Combustible Liquid.....	COMBUSTIBLE.....
4.1.....	FLAMMABLE SOLID.....
4.2.....	SPONTANEOUSLY COMBUSTIBLE.....
5.1.....	OXIDIZER.....
5.2 (Other than organic peroxide, Type B, liquid or solid, temperature controlled).....	ORGANIC PEROXIDE.....
6.1 (Other than materials poisonous by inhalation).....	POISON.....
6.2.....	(None).....
8.....	CORROSIVE.....
9.....	Class 9 (See §172.504(f)(9)).....
ORM-D.....	(None).....

## IDENTIFICATION NUMBER DISPLAYS



§172.332

Appropriate placard must be used with orange panel.

IDENTIFICATION NUMBER MARKINGS ON ORANGE PANELS OR APPROPRIATE PLACARDS MUST BE DISPLAYED ON: (1) Tank Cars, Cargo Tanks, Portable Tanks, and other Bulk Packagings; (2) Transport vehicles or freight containers containing 4,000 kg (8,820 lbs) in non-bulk packages of only a single hazardous material having the same proper shipping name and identification number loaded at one facility and transport vehicle contains no other material, hazardous or otherwise; and (3) transport vehicles or freight containers containing 1,000 kg (2,205 lbs) of non-bulk packages of materials poisonous by inhalation in Hazard Zone A or B. See §§172.301(a)(3), 172.313(c), 172.326, 172.328, 172.330, and 172.331.

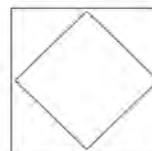

§172.527

Square white background required for placard for highway route controlled quantity radioactive material and for rail shipment of certain explosives and poisons, and for flammable gas in a DOT 113 tank car [§172.507 and §172.510].

This Chart is available online at the following link:  
<http://phmsa.dot.gov/hazmat>



U.S. Department of Transportation  
Pipeline and Hazardous Materials Safety Administration

USDOT/PHMSA/OHMIT/PHH-50  
1200 New Jersey Avenue, SE  
Washington, D.C. 20590  
Phone: (202) 366-4900  
Email: training@dot.gov

PHH50-0138-0413



## DOT System of Placards and Labels

The Department of Transportation (DOT) regulates labels and placards that must appear on hazardous materials containers and vehicles in transport.

Placarding requirements are very specific. Placards indicate the primary hazard associated with the material being transported. For example, a cargo tank shipment of gasoline must be placarded as a Flammable (Class 3); one carrying chlorine must be placarded as a gas posing an Inhalation Hazard (Class 2.3).

### Table 1 and Table 2

Materials are categorized as Table 1 or Table 2 materials in 49 CFR.

**Materials categorized as Table 1 are required to display an identifying placard, regardless of amount of product in transport.** Table 1 products include:

- Explosives (Classes 1.1, 1.2 and 1.3)
- Poison Gas (Class 2.3)
- Dangerous When Wet (Class 4.3)
- Organic Peroxides, Type B temperature-controlled solids and liquids (Class 5.2)
- Poison (Class 6.1, only those that are inhalation hazards)
- Radioactive (Class 7, in Radioactive III packaging only)

All other classes of hazardous materials are categorized as Table 2. Bulk shipments of 1,001 pounds or more of one specific material must have a respective hazard class appear on the placard when being transported between states.

### The Dangerous Placard

The Dangerous placard can be used if a shipment contains a mixed load of non-bulk packages. For example, a highway box truck which contains packages of two or more different Table 2 materials is allowed to be placarded with the DANGEROUS placard rather than having to carry a specific placard for each material on board. However, when 2,205 or more pounds of one type of material is loaded at a facility, its defining Table 2 placard must be affixed.





## General Characteristics and Requirements

DOT placards are diamond-shaped signs that are 10¾ inches square. They are required to be affixed on each side and each end of any vehicle carrying hazardous materials. A placard will contain a background color, a symbol and a class number. It may also include a four-digit identification number in cases of bulk shipment. Except for wordless placards, the name of the hazard class will be indicated.

DOT labels are four-inch diamonds affixed to non-bulk packages of hazardous materials. Generally, they are required for the same materials which require placards. Labels must be affixed to two opposite sides of a package, or on the side and the top of drums.

When only one label is required, it must be affixed on or near the package closure. If two or more different labels are required, they must be positioned next to one another. Labels must be affixed near the shipping name of the material. The class number must be displayed on a subsidiary label when the material has multiple hazards.

Both DOT placards and labels convey information by their color and symbol, the United Nations (UN) class number, and hazard class description or four-digit ID number.

Other labels may be present on packages—for example, labels required to meet the revised Hazard Communication Standard, 29 CFR 1910.1200, which will now comply with the Globally Harmonized System (which will be discussed later in this lesson, as well as within the lesson titled, Shipping Papers and Facility Documents).

### Reference

The OSHA documents related to the Globally Harmonized System are located in the appendices.

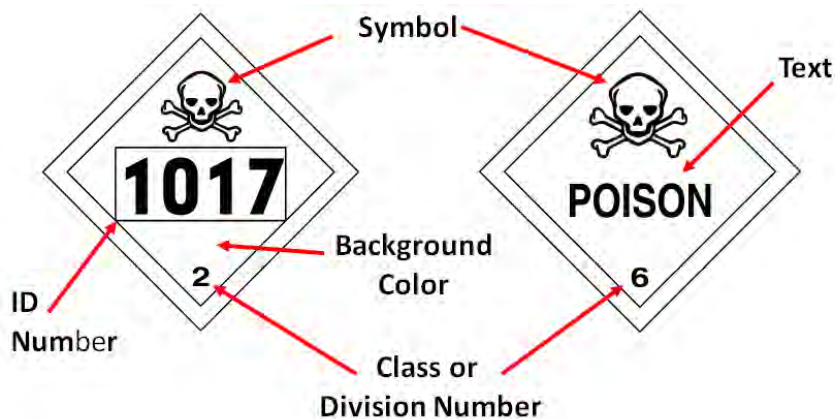





## Colors, Definitions and Hazards

Both DOT placards and labels convey information by their color and symbol, the United Nations (UN) class number, and hazard class description or four-digit ID number.









Placard Colors	Definitions and Hazards
Orange	<b>Explosive:</b> a substance, article, device designed to function via an extremely rapid release of gas and heat, or function in a similar manner by chemical reaction
Red	<b>Flammable Liquid:</b> any liquid with a flash point of not more than 60.5°C (141°F)  <b>Combustible Liquid:</b> any liquid that does not meet the definition of any other hazard class and has a flash point about 60°C (140°F) and below 93.3°C (200°F)  <b>Flammable Gas:</b> any material that is a gas and has a boiling point at 20°C (68°F) or less and 101.3 kPa (14.7 psi) of pressure, and is ignitable at 101.3 kPa (14.7 psi) when in a mixture of 13% or less by volume with air, or has a flammable range of 101.3 kPa (14.7 psi) with air of at least 12%, regardless of the lower limit
Green	<b>Non-Flammable Gas:</b> any material (or mixture) that exerts in the packaging an absolute pressure of 280 kPa (41 psia) at 20°C (68°F)
White	<b>Poisonous Material:</b> materials other than gases, known or presumed to be so toxic to humans that they afford a hazard to health during transportation
White with vertical red stripes	<b>Flammable Solid:</b> consists of wetted explosives, self-reactive materials or readily combustible solids
White over red	<b>Spontaneously Combustible:</b> pyrophoric or self-heating material
Blue	<b>Dangerous When Wet:</b> material that, by contact with water, is liable to become spontaneously flammable or give off flammable or toxic gas at a rate greater than 1 L/kg of the material per hour
Yellow*	<b>Oxidizer:</b> materials that can cause or enhance combustion  <b>Organic Peroxide:</b> any organic compound containing oxygen in the bivalent structure that can be considered a derivative of hydrogen peroxide
Yellow over white	<b>Radioactive Material:</b> any material having a specific activity greater than 0.002 microcuries per gram
White over black	<b>Corrosive Material:</b> a liquid or solid that causes visible destruction or irreversible alterations in human skin tissue, or a liquid that has a severe corrosion rate on steel or aluminum
Black stripes over white	<b>Miscellaneous Hazardous Material:</b> a material that presents a hazard during transport, but is not included in another hazard class
Red with a white band in the center	<b>Dangerous:</b> placard for a container, vehicle or rail car containing non-bulk packaging with two or more categories of hazardous materials that require different placards (used alone, instead of the two placards)
Red over yellow	An organic compound that contains the bivalent (-O-O-) structure which is a strong oxidizing agent and may be liable to explosive decomposition, be sensitive to heat, shock or friction or react dangerously with other hazardous materials. Commonly used in automobile body shops as body filler (example: dibenzoyl peroxide).

\*Note: Oxygen may be shipped as a Class 2 Compressed Gas with a yellow label.





## Symbols, Hazards and Table Assignments







Symbol	Associated Hazards and Table Assignment	
	<b>EXPLOSIVE</b>	
	Table 1: Classes 1.1, 1.2, 1.3	Table 2: Classes 1.4, 1.5, 1.6
	<b>FLAMMABLE</b>	
	Table 2: Class 3	
	<b>DANGEROUS WHEN WET</b>	
	Table 1: Class 4.3	
	<b>POISONOUS MATERIAL</b>	
	Table 1: Classes 2.3, 6.1 (inhalation hazard)	Table 2: Class 6.1 (other than inhalation)
	<b>OXIDIZING MATERIAL OR ORGANIC PEROXIDE</b>	
	Table 1: Class 5.2	Table 2: Class 5.1
	<b>NON-FLAMMABLE GAS</b>	
	Table 2: Class 2.2	
	<b>RADIOACTIVE</b>	
	Table 1: Class 7	
	<b>CORROSIVE</b>	
		Table 2: Class 8
	<b>INFECTIOUS SUBSTANCE</b>	
	On labels only	

Hazard Class 1.1 poses the greatest hazard (explosives with a mass explosion capability).



## DOT Table 1 Materials

**Certain categories of materials must always be placarded with their primary hazard placards, regardless of the amount being transported.** These are referred to as Table 1 materials because they appear in Table 1 of the placarding section of the Code of Federal Regulations (49 CFR 172.500).

If vehicle contains a material classified as:	Then it must show this placard:	Examples of materials:
Explosives (Division 1.1) (Division 1.2) (Division 1.3)	 ORANGE	TNT Black powder Dynamite
Poison Gas (Division 2.3)	 WHITE	Arsine Phosgene Chlorine
Dangerous When Wet (Division 4.3)	 BLUE	Calcium carbide Potassium Sodium
Poison (Toxic Materials), Inhalation Hazards (Division 6.1)	 WHITE	Aniline Phenol
Radioactive (Class 7, those substances in Radioactive III packaging only)	 YELLOW OVER WHITE	Cobalt Uranium
Organic peroxide, Type B, liquid or solid, temperature controlled (Division 5.2)	 RED OVER YELLOW	Dibenzoyl peroxide



## DOT's Flammable Gas Definition

According to the DOT, a flammable gas is any material which is:

- A gas at 68 °F (20 °C) or less and 14.7 psia (101.3 kPa) of pressure (a material which has a boiling point of 68 °F (20 °C) or less at 14.7 psia (101.3 kPa)) which:
  - Is ignitable at 14.7 psia (101.3 kPa) when in a mixture of 13 percent or less by volume with air.
  - Has a flammable range at 14.7 psia (101.3 kPa) with air of at least 12 percent regardless of the lower limit<sup>1,2</sup>

Which, if any, of the listed gases are flammable according to the above-stated criteria? Complete the table below to indicate whether the gas is a flammable gas and why.

Name of Gas	LEL	UEL	Flammable Gas/ Explanation
Methane	5.0%	15.0%	
Butane	1.6%	8.4%	
Propane	2.1%	9.5%	
Acetylene	2.5%	100.0%	
Carbon monoxide	12.5%	74.0%	
Ammonia, anhydrous	16.0%	25.0%	
Methylene chloride (about 100 °F)	13.0%	23.0%	





1 Class 2, Divisions 2.1, 2.2, and 2.3—Definitions. Title 49 (Transportation) CFR 173.115-10-1-11 Edition. Electronic Code of Federal Regulations. <http://www.gpo.gov/fdsys/pkg/CFR-2011-title49-vol2/pdf/CFR-2011-title49-vol2-sec173-115.pdf> (retrieved April 24, 2014).

2 Classification of Petroleum Crude Oil. Pipeline and Hazardous Materials Safety Administration, Office of Hazardous Materials Safety. [http://www.phmsa.dot.gov/staticfiles/PHMSA/DownloadableFiles/Petro%20Crude%20Classification%20\(Final\).pdf](http://www.phmsa.dot.gov/staticfiles/PHMSA/DownloadableFiles/Petro%20Crude%20Classification%20(Final).pdf) (retrieved April 24, 2014).









## DOT Table 2 Materials



Table 2 includes all other hazardous materials that need to be placarded. However, these materials **do not need to be placarded unless 1,001 pounds or more** are being carried (of any one, or a combination of two or more Table 2 materials). In other words, **any** quantity of Table 1 material must be placarded, but Table 2 materials require placards **only** if the gross weight is 1,001 pounds or more.

If vehicle contains a material classified as:	Then it must show this placard:	Examples of materials:
Explosives (Division 1.4)	 ORANGE	Fireworks Ammunition
Explosives (Division 1.5)	 ORANGE	Ammonium nitrate fuel oil mixture (ANFO)
Explosives (Division 1.6)	 ORANGE	Articles, explosive, extremely insensitive (EEI)
Flammable gas (Division 2.1) LEL < 13% or flammable range > 12%	 RED	Propane Acetylene
Non-flammable gas (Division 2.2)	 GREEN	Carbon dioxide Anhydrous ammonia Oxygen



If vehicle contains a material classified as:	Then it must show this placard:	Examples of materials:
Flammable liquid (Class 3)	 RED	Gasoline Diesel fuel
Combustible liquid (Class 3)	 RED	Fuel oil
Flammable solid (Division 4.1)	 WHITE WITH VERTICAL RED STRIPES	Nitrocellulose
Spontaneously combustible (Division 4.2)	 WHITE OVER RED	Phosphorous Aluminum alkyls
Oxidizer (Division 5.1)	 YELLOW	Ammonium nitrate Fertilizer Hydrogen peroxide
Organic peroxide: other than Type B, liquid or solid, temperature controlled (Division 5.2)	 YELLOW	Dibenzoyl peroxide



If vehicle contains a material classified as:	Then it must show this placard:	Examples of materials:
Toxic materials: other than Inhalation Hazard Zone A or B (Class 6.1)	 WHITE	Arsenic
Corrosive (Class 8)	 WHITE OVER BLACK	Nitric acid Sulfuric acid Hydrochloric acid
Miscellaneous (Class 9)	 VERTICAL BLACK STRIPES OVER WHITE	Dry ice PCBs Pharmaceuticals Certain cosmetics Molten sulfur

## Limited Quantity Marking

All materials which meet the criteria of one of the nine (9) hazard classes are regulated as hazardous materials for transport. However, when the amount of certain hazardous material packed within a package is limited, the magnitude of the hazard is reduced but not eliminated. Thus, exceptions can be applied for packaging and hazard communication as authorized for certain hazard classes.



In order to qualify for these exceptions, the United States' hazardous materials regulations (49 CFR Parts 171-180) authorize specific quantity limitations per inner and outer packaging for each hazard class and packing group. If the quantity of material contained within the inner packaging is below these limitations, and the gross weight of the outer package is within the authorized limits the consignment may be offered for transportation as a limited quantity. (<http://chemtelinc.com/index.php/guide-to-limited-quantities>)

## Mixed Loads

The Dangerous placard can be used if a shipment contains a mixed load of non-bulk packages. A freight container, unit load device, transport vehicle, or rail car which contains non-bulk packaging with two or more categories of hazardous materials that require different placards specified in Table 2 may be placarded with DANGEROUS placards instead of the specific placards required for each of the materials in Table 2. However, when 1,000kg (2,205lbs) or more of one category of material is loaded at one loading facility, the placard specified in Table 2 must be applied.



## ORM-D

An ORM-D is a material such as a consumer commodity, which presents a limited hazard during transportation due to its form, quantity and packaging. It must be a material for which exceptions are provided in 172.101. Shipping descriptions applicable to ORM-D materials are found in 49 CFR 172.101. (49 CFR 173.500(b)(4))





## Environmentally Hazardous Substance Labels

Environmentally Hazardous Substance labels are mandatory for all shipments by sea containing materials hazardous to marine life. It is required for combination packages where the inner package or single package is larger than 5 L (1.32 gal.) for liquids or 5 kg (11 lbs.) for solids.



## United Nations (UN) Identification Numbers

The four-digit identification number may replace the descriptive text in the center of the placard for bulk shipments of hazardous materials. However, it cannot replace the Dangerous placard or the class name for Radioactive Materials or any class of Explosives.

UN identification numbers can be incorporated into a DOT placard, or posted on a separate orange panel next to the placard. For example, the numbers may be displayed:

- In four-inch black numbers on a 6¾ x 15¾ inch orange panel adjacent to the placard



- In the center of the placard (except on Explosive, Radioactive and Dangerous)



### MUST BE DISPLAYED ON:

- ▶ Tank Cars, Cargo Tanks, Portable Tanks and other-Bulk Packages
- ▶ Vehicles or containers containing 8,820 lbs (4,000 kg) in non-bulk packages of only a single hazardous material having the same proper shipping name and identification number
- ▶ 2,205 lbs (1,000 kg) of materials poisonous by inhalation in Hazard Zone A or B

## Frequently Encountered Placards

Placard number	Product
1001	Acetylene
1005	Ammonia
1017	Chlorine
1075	Propane
1202 1993	Diesel
1203	Gasoline
1831	Sulfuric acid
2020	Solid chlorophenol







## Radioactive Labels

Placards are required for Table 1 Radioactives (Radioactive III) or for shipments of >1,001 lbs. of non-Table 1. These shipments are rare, except in the case of low specific activity (LSA) waste.

Radioactive material is the only hazardous material which has three possible labels, depending on the relative radiation levels external to the package. Also, labels for radioactive material are the only ones that require the shipper to write some information on the label. In all cases, labels for the radioactive packages will help the responder determine the contents and activity of the materials.

The information required on the labels includes:

- **Contents:** Listing the radioisotope inside package
- **Activity:** Listing the number of disintegrations per minute
- **Transport Index:** Listing the amount of radiation at surface of package and/or at 1 meter from package

	<p><b>AT SURFACE:</b> Does not exceed 0.5 mrem/hr</p> <p><b>1 METER FROM SURFACE:</b> Not applicable</p>	<p>Will list contents and activity only.</p>
	<p><b>AT SURFACE:</b> Does not exceed 50 mrem/hr</p> <p><b>AND</b></p> <p><b>1 METER FROM SURFACE:</b> Does not exceed 1 mrem/hr</p>	<p>Will list contents, activity and transport index.</p>
	<p><b>AT SURFACE:</b> Not to exceed 200 mrem/hr</p> <p><b>AND</b></p> <p><b>1 METER FROM SURFACE:</b> Not to exceed 10 mrem/hr</p>	<p>Will list contents, activity and transport index.</p>
 <p>Isotopes—atoms of the same element can have different numbers of neutrons; the different possible versions of each element are called isotopes.</p>	<p><b>Criticality Safety Index:</b> Assigned to a package, overpack or freight container containing fissile material is a number which is used to provide control over the accumulation of packages, overpacks or freight containers containing fissile material</p>	<p>Designed to keep an excess of packages from reacting—reaching critical mass.</p>



## Hazardous Materials Response Case Study

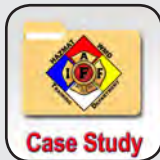

At 2200 hours, you respond to a motor vehicle accident on a major highway. It is partly cloudy, with temperature in the mid 70s °F. A tank truck has collided with a small four-door passenger car. The car broad sided the trailer, running underneath the valve assembly in the middle of the trailer.

The driver, a young mother of two, is trapped in the car. The children are in their car seats, in the back seat of the vehicle. There is no fire. As the first engine company arrives, they discover product spilling from a damaged valve on the underside of the tank truck, where the car hit it. The spilled material is beginning to pool. The truck driver is present, and unhurt. He says he just loaded the trailer a few miles back, and is trying to make a delivery in the morning, in a town about 200 miles away.

*Consider the chain of events, and then determine some things you would like to know before attempting to respond to this incident. Use the space below for your notes.*

Information needed BEFORE attempting to take action at this incident.
1.
2.
3.
4.
5.

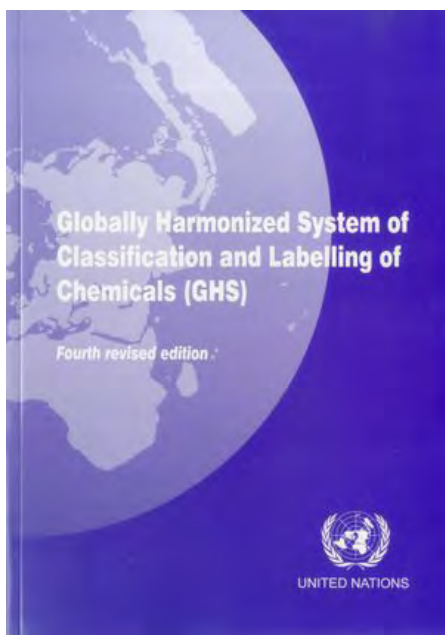

## What Is the Globally Harmonized System (GHS)?

GHS stands for the Globally Harmonized System of Classification and Labeling of Chemicals. GHS is a system that defines and classifies the hazards of chemical products, and communicates health and safety information on labels and material safety data sheets (called Safety Data Sheets, or SDSs). The goal is that the same set of rules for classifying hazards, and the same format and content for labels and SDSs will be adopted and used around the world. An international team of hazard communication experts developed GHS.<sup>1</sup>

## Why Is Global Harmonization Necessary?

Currently many different countries have different systems for classification and labeling of chemical products. In addition, several different systems can exist even within the same country. This situation has been expensive for governments to regulate and enforce, costly for companies who have to comply with many different systems, and confusing for workers who need to understand the hazards of a chemical in order to work safely.

## Implementation in the United States

The Hazard Communication Standard (HCS) is now aligned with the Globally Harmonized System of Classification and Labeling of Chemicals (GHS). This update to the Hazard Communication Standard (HCS) will provide a common and coherent approach to classifying chemicals and communicating hazard information on labels and safety data sheets. Once implemented, the revised standard will improve the quality and consistency of hazard information in the workplace, making it safer for workers by providing easily understandable information on appropriate handling and safe use of hazardous chemicals. This update will also help reduce trade barriers and result in productivity improvements for American businesses that regularly handle, store and use hazardous chemicals while providing cost savings for American businesses that periodically update safety data sheets and labels for chemicals covered under the hazard communication standard.

OSHA is requiring that employees are trained on the new label elements (i.e., pictograms, hazard statements, precautionary statements and signal words) and SDS format by December 31, 2013, while full compliance with the final rule will begin in 2015. OSHA believes that American workplaces will soon begin to receive labels and SDSs that are consistent with the GHS, since many American and foreign chemical manufacturers have already begun to produce HazCom 2012/GHS-compliant labels and SDSs. It is important to ensure that, when employees begin to see the new labels and SDSs in their workplaces, they will be familiar with them, understand how to use them, and access the information effectively. For more information, see <http://www.osha.gov/dsg/hazcom/effectivedates.html>.

The three major changes are in hazard classification, labels and safety data sheets.









- ▶ **Hazard classification:** The definitions of hazard have been changed to provide specific criteria for classification of health and physical hazards, as well as classification of mixtures. These specific criteria will help to ensure that evaluations of hazardous effects are consistent across manufacturers, and that labels and safety data sheets are more accurate as a result.
- ▶ **Labels:** Chemical manufacturers and importers will be required to provide a label that includes a harmonized signal word, pictogram, and hazard statement for each hazard class and category. Precautionary statements must also be provided.
- ▶ **Safety Data Sheets:** Will now have a specified 16-section format.

<sup>1</sup> Globally Harmonized System (GHS), <http://www.ccohs.ca/oshanswers/chemicals/ghs.html> (retrieved July 1, 2013)



## Hazard Communication Standard Pictograms

As of June 1, 2015, the Hazard Communication Standard (HCS) will require pictograms on labels to alert users of the chemical hazards to which they may be exposed. Each pictogram consists of a symbol on a white background framed within a red border and represents a distinct hazard(s). The pictogram on the label is determined by the chemical hazard classification.

<p><b>Health Hazard</b></p>  <ul style="list-style-type: none"> <li>• Carcinogen</li> <li>• Mutagenicity</li> <li>• Reproductive Toxicity</li> <li>• Respiratory Sensitizer</li> <li>• Target Organ Toxicity</li> <li>• Aspiration Toxicity</li> </ul>	<p><b>Flame</b></p>  <ul style="list-style-type: none"> <li>• Flammables</li> <li>• Pyrophorics</li> <li>• Self-Heating</li> <li>• Emits Flammable Gas</li> <li>• Self-Reactives</li> <li>• Organic Peroxides</li> </ul>	<p><b>Exclamation Mark</b></p>  <ul style="list-style-type: none"> <li>• Irritant (skin and eye)</li> <li>• Skin Sensitizer</li> <li>• Acute Toxicity</li> <li>• Narcotic Effects</li> <li>• Respiratory Tract Irritant</li> <li>• Hazardous to Ozone Layer (Non-Mandatory)</li> </ul>
<p><b>Gas Cylinder</b></p>  <ul style="list-style-type: none"> <li>• Gases Under Pressure</li> </ul>	<p><b>Corrosion</b></p>  <ul style="list-style-type: none"> <li>• Skin Corrosion/ Burns</li> <li>• Eye Damage</li> <li>• Corrosive to Metals</li> </ul>	<p><b>Exploding Bomb</b></p>  <ul style="list-style-type: none"> <li>• Explosives</li> <li>• Self-Reactives</li> <li>• Organic Peroxides</li> </ul>
<p><b>Flame Over Circle</b></p>  <ul style="list-style-type: none"> <li>• Oxidizers</li> </ul>	<p><b>Environment (Non-Mandatory)</b></p>  <ul style="list-style-type: none"> <li>• Aquatic Toxicity</li> </ul>	<p><b>Skull and Crossbones</b></p>  <ul style="list-style-type: none"> <li>• Acute Toxicity (fatal or toxic)</li> </ul>



### NFPA Diamond Example



- Health Hazard → Blue
- Flammability Hazard → Red
- Reactivity Hazard → Yellow
- Special Hazard → White

The numbers in this example indicate a very significant health hazard (4), a significant flammability hazard (3) and moderate reactivity (2). The W indicates the special hazard of water-reactivity.

## NFPA 704 Marking System

The National Fire Protection Association (NFPA) has developed a marking system for fixed sites to indicate the dangers associated with various hazardous materials handled at a location. This marking system is not used in transportation, and is not federally regulated or required. However, it can be mandated by local ordinance.

The NFPA marking system (detailed in NFPA 704) uses a diamond divided into four color-coded quadrants. Each quadrant is a specific color and indicates a hazard type:

- Health Hazard: Blue
- Flammability Hazard: Red
- Reactivity Hazard: Yellow
- Special Hazard: White

The health, flammability and reactivity hazards are ranked from zero to four. Zero indicates no risk and four indicates the greatest possible risk. The hazard area may contain a special symbol or letter to indicate a specific danger. The health hazards, flammability hazards and reactivity hazards are described in detail on the next page.

NFPA recognizes two types of special hazard symbols:

- OX indicates an oxidizer
- W indicates a water-reactive material

Although not recognized by NFPA, some localities may insert the letters ALK for alkaline materials and ACID for acidic materials. A trefoil indicates radioactive, COR indicates corrosive, and SA indicates simple asphyxiant. The pre-incident planning stage affords an ideal opportunity to note such local practices.

### Key Point

Since different hazardous materials may be stored together at a fixed site, the NFPA 704 numbers displayed often represent a cumulative hazard rating for all of the materials stored. Alone, very few materials have an NFPA 704 rating of 4-4-4, although first responders are likely to see such a rating at a fixed site where multiple different products are manufactured or stored.







<b>NFPA 704 Marking System</b>			
<b>Number</b>	<b>Health Hazard</b>	<b>Flammability Hazard</b>	<b>Reactivity Hazard</b>
<b>4</b> EXTREME	Very short exposure could cause death or major residual injury.	Very flammable gases or very volatile flammable liquids. Shut off flow and keep cooling water streams on exposed tanks or containers.	Capable of detonation or explosive reaction at normal temperatures and pressures; sensitive to mechanical or localized thermal shock.
<b>3</b> HIGH	Short exposure could cause serious temporary or residual injury.	Materials which can be ignited under almost all normal temperature conditions. Water may be ineffective because of the low flash point.	Capable of detonation or explosive reaction if exposed to a strong ignition source or if heated under confinement; may react explosively with water.
<b>2</b> MODERATE	Intense or continued (but not chronic) exposure could cause temporary incapacitation or possible residual injury.	Materials which must be moderately heated for ignition to occur. Water spray extinguishes fire because material can be cooled below its flash point.	Readily undergoes violent chemical change at elevated temperatures and pressures; may react violently with water.
<b>1</b> SLIGHT	Exposure could cause irritation, but only minor residual injury.	Materials that must be preheated before ignition can occur. Water fog gently applied to the surface of the material will extinguish the fire.	May become unstable when exposed to heat and pressure; may react with water, but not violently.
<b>0</b> LEAST	Exposure under fire conditions would present no hazard beyond that of ordinary combustible material.	Material that will not burn.	Normally stable, even under fire conditions; not water reactive.



## Comparison of NFPA 704 and HazCom 2012 Labels

	 NFPA 704	 HazCom 2012
Purpose	Provides basic information for emergency personnel responding to a fire or spill and those planning for emergency response.	Informs workers about the hazards of chemicals in workplace under normal conditions of use and foreseeable emergencies.
Number System: NFPA Rating and OSHA's Classification System	0-4 0-least hazardous 4-most hazardous	1-4 1-most severe hazard 4-least severe hazard • The Hazard category numbers are NOT required to be on labels but are required on SDSs in Section 2. • Numbers are used to CLASSIFY hazards to determine what label information is required.
Information Provided on Label	<ul style="list-style-type: none"> <li>• Health-Blue</li> <li>• Flammability-Red</li> <li>• Instability-Yellow</li> <li>• Special Hazards*-White</li> </ul> *OX Oxidizers W Water Reactives SA Simple Asphyxiants	<ul style="list-style-type: none"> <li>• Product Identifier</li> <li>• Signal Word</li> <li>• Hazard Statement(s)</li> <li>• Pictogram(s)</li> <li>• Precautionary statement(s); and</li> <li>• Name address and phone number of responsible party.</li> </ul>
Health Hazards on Label	Acute (short term) health hazards ONLY. Acute hazards are more typical for emergency response applications. Chronic health effects are not covered by NFPA 704.	Acute (short term) and chronic (long term) health hazards. Both acute and chronic health effects are relevant for employees working with chemicals day after day. Health hazards include acute hazards such as eye irritants, simple asphyxiants and skin corrosives as well as chronic hazards such as carcinogens.
Flammability/ Physical Hazards on Label	NFPA divides flammability and instability hazards into two separate numbers on the label. Flammability in red section Instability in yellow section	A broad range of physical hazard classes are listed on the label including explosives, flammables, oxidizers, reactives, pyrophorics, combustible dusts and corrosives.
Where to get information to place on label	Rating system found in NFPA Fire Protection Guide to Hazardous Materials OR NFPA 704 Standard System for Identification of the Hazards of Materials for Emergency Response 2012 Edition. Tables 5.2, 6.2, 7.2 and Chapter 8 of NFPA 704	OSHA Hazard Communication Standard 29 CFR 1910.1200 (2012). 1) Classify using Appendix A (Health Hazards) and Appendix B (Physical Hazards) 2) Label using Appendix C
Other	The hazard category numbers found in section 2 of the HC2012 compliant SDSs are NOT to be used to fill in the NFPA 704 diamond.	Supplemental information may also appear on the label such as any hazards not otherwise classified, and directions for use.
website	<a href="http://www.nfpa.org/704">www.nfpa.org/704</a>	<a href="http://www.osha.gov">www.osha.gov</a> OR <a href="http://www.osha.gov/dsg/hazcom/index.html">www.osha.gov/dsg/hazcom/index.html</a>

For more information:





The substance: "NOMIXUP 7042012"

**To create an OSHA label per HazCom 2012:**

**Step 1:** Perform the classification in accordance with Appendix A: Health Hazards & Appendix B Physical Hazards of 29 CFR 1910.1200 - this is where you find the criteria for each hazard class and hazard category.

Class: Flammable Gas, Category 1

Class: Carcinogen, Category 1B

Class: Specific Target Organ Toxicity (Single Exposure), Category 3

Class: Substances and Mixtures Which, in Contact with Water, Emit Flammable Gases, Category 3

**Step 2:** Gather labeling information (Pictograms, Signal Word, Hazard Statements) from Appendix C of 29 CFR 1910.1200 based on the chemical's hazard class and category.

**Step 3:** Create the Label

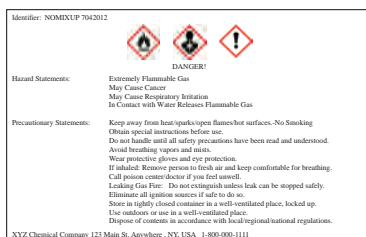

**To Create NFPA 704 label:**

**Step 1:** Collect information on hazards from applicable sections of SDS. Some SDSs may provide the NFPA diamond symbol with hazard rating numbers filled in already. Note: Do NOT use the hazard category numbers given in section 2 of HazCom 2012 compliant SDS on 704 label!

If the diamond is not provided on the SDS you can obtain the information under the following sections of the SDS. Note that additional information may be provided in other sections of the SDS.

- Health hazard information under Section 11
- Flammability information under Section 9
- Instability information under Section 10
- Special information under Section 9, 10, 11

**Step 2:** Obtain current edition copy of NFPA 704 or view on line at [www.nfpa.org/704](http://www.nfpa.org/704). Compare the criteria on the SDS sections as shown above with the criteria shown in Tables 5.2 (Health), 6.2 (Flammability), 7.2 (Instability) and 8.2 (Special Hazards)

**Step 3:** Place numbers for the degree of hazard associated with the criteria obtained in Step 2 in the correct quadrant of NFPA 704 placard.

NFPA Label for NOMIXUP 7042012



For more information:



National Fire Protection Association  
[www.nfpa.org](http://www.nfpa.org) | 800.344.3555





Occupational Safety  
and Health Administration  
U.S. Department of Labor  
[www.osha.gov](http://www.osha.gov) | 800.321.OSHA (6742)









## Quiz on Placards, Labels and Markings

Work with your team to complete the quiz items below.

Match the 704 symbol below with the most nearly correct description below. Some symbols may be used more than once.

	1. Poses the greatest health hazard
	2. The most flammable product
	3. The most reactive product
	4. The water-reactive product
	
A	
	
B	
	
C	

Match the placards and labels below with the most nearly correct descriptions. Some placards may be used more than once; some are not used at all. Mark 'N' if no answer is correct.

	1. A flammable liquid		
	2. A product that may release oxygen		
	3. Medical waste		
	4. TNT		
	5. Radioactive material		
	6. Organic peroxide		
	7. A spontaneously combustible product		
	8. Corrosive product		
			
A.	B.	C.	D.
			
E.	F.	G.	



## Hazardous Materials Identification System

The Hazardous Materials Identification System® (HMIS®) is very similar to the NFPA® marking system. HMIS® was developed by the National Paint and Coatings Association (NCPA), now known as the American Coatings Association, to help employers comply with OSHA's Hazard Communication Standard (HAZCOMM). HMIS® is currently in its third edition.

HMIS® communicates hazard information through training and the use of colors, numbers, letters of the alphabet, and symbols that include pictograms of types of personal protective equipment (PPE) and icons for Target Organs and Physical Hazards.<sup>1</sup> HMIS® labels communicate the:

- Name of the material (top, white bar)
  - An asterisk (\*) indicates the health hazard associated with the chemical is a chronic (long-term effect)<sup>2</sup>
- Health hazard (blue bar)
- Flammability (red bar)
- Physical hazards (orange bar)
- Personal protective equipment that should be used (white, bottom bar)

Hazards for health, flammability and physical hazards are rated as follows:

- 0 = Minimal Hazard
- 1 = Slight Hazard
- 2 = Moderate Hazard
- 3 = Serious Hazard
- 4 = Severe Hazard











1 HMIS® Implementation Manual, Third Edition. [www.jjkeller.com](http://www.jjkeller.com) (retrieved January 8, 2014).  
2 Safety in the Chemistry Laboratory. <http://chemlabs.uoregon.edu/Safety/HMIG.html> (retrieved January 8, 2014).



## Military Marking System (Fire and Explosion Hazards)

The military has developed its own marking system, which is used on military shipments and at fixed site facilities. This system consists of seven symbols that identify detonation, fire and special hazards. The seven military class markings are as follows. The Class 1 – 4 symbols have an orange background with black numbers.

Military Marking System			
	Class 1: Mass Detonation Hazard  ORANGE BACKGROUND BLACK TEXT		Chemical Hazard Symbol: Highly toxic chemical agents  BLUE BACKGROUND RED TEXT
	Class 2: Explosion with Fragmentation Hazard  ORANGE BACKGROUND BLACK TEXT		Chemical Hazard Symbol: Harassing agents  BLUE BACKGROUND YELLOW TEXT
	Class 3: Mass Fire Hazard  ORANGE BACKGROUND BLACK TEXT		Chemical Hazard Symbol: White phosphorus munitions  BLUE BACKGROUND WHITE TEXT
	Class 4: Moderate Fire Hazard  ORANGE BACKGROUND BLACK TEXT		Apply No Water  WHITE BACKGROUND BLACK AND RED TEXT
			Wear Protective Mask or Breathing Apparatus  BLUE BACKGROUND WHITE TEXT





## Pesticides Label Marking

The U.S. Environmental Protection Agency (EPA) monitors the use and labeling of agricultural chemicals and pesticides, including those materials regulated by DOT for interstate transport. EPA labeling requirements are usually incorporated into the manufacturer's product labels, which must include:

- The name of the product
- The name and address of the manufacturer
- The product number registered with EPA (pest control number in Canada)
- Active ingredients
- Specific warning statements (warning statements typically appear on the back label and describe the health effects of the pesticide and instructions for avoiding contact)

### Signal Word

The EPA signal word, usually found at the center of the front panel of the product label, indicates how hazardous the pesticide is. However, under extreme conditions, some low toxicity pesticides can become much more hazardous. One of three signal words must appear on the front of the label.

1. **Danger:** required for highly toxic materials (the word Poison may also appear if the pesticide is easily absorbed into the body)
2. **Warning:** required for moderately toxic materials
3. **Caution:** required for materials with relatively low toxicity

People tend to take these signal words lightly because they are so accustomed to seeing them on agricultural products. The fact is, many of these materials can be extremely dangerous, especially in uncontrolled situations such as fire. For example, Dieldrin (an insecticide used in termite control) is only required to be labeled with the EPA signal word Caution, however it may produce highly poisonous gases when heated.

### Signal Words Indicating Degree of Hazard (Pesticides)

Hazard Indicators	I: Danger	II: Warning	III: Caution
Oral LD <sub>50</sub> (mg/kg)	≤50	50 – 500	500 – 5,000
Dermal/Skin Contact LD <sub>50</sub> (mg/kg)	≤200	200 – 2,000	2,000 – 20,000
Inhalation LC <sub>50</sub> (mg/L)	≤0.2	0.2 – 2	2 – 20

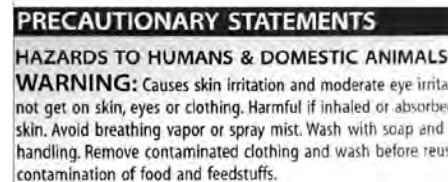
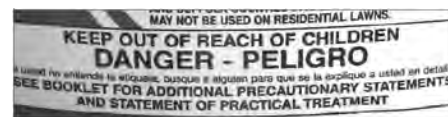

Sample Pesticide Labels



## Precautionary Statement

A statement of practical treatment, also called the first aid statement, may appear near the signal word on the front panel. The statement may include both precautionary information and instructions about what to do in case of exposure. There may also be a note to the physician giving antidotal or treatment information. The note to the physician and practical treatment statement may be located together.

## Hazard Statement

Some pesticide labels may also include a statement about physical or chemical hazards. This statement will be on a side panel of the label and will list any special flammability, explosion or chemical hazards that the product may have. Caustics, acids, oxidizers and pressure containers will have such precautionary statements.

## Name of Pesticide

The product's chemical and brand names will appear on the front panel. Use this information to obtain the correct spellings and full names of the product so that you can consult other sources for additional information.

## Active Ingredient

All pesticide containers must have ingredient labels. The ingredients are listed as active or inert. Active ingredients must be listed by chemical name. Sometimes the common name is also listed. Inert ingredients usually are not named; only their total percentage is given. Remember, however, that inert ingredients can also be hazardous.

## EPA Registration Number

The EPA registration number must also appear on every pesticide label. This number is essential to positively identify the product and formulation. All pesticides sold in the U.S. must bear an EPA registration number. This number appears as a hyphenated number, such as: 1234-56 or 1234-56-789. For example, the EPA registration number for Prentox Cube® Flea and Tick Dip (rotenone) is 655-688. When referring to the number, indicate all dashes.

- The first set of numbers identifies the manufacturer
- The second set of numbers identifies the specific product
- The third set of numbers, if present, is an alternate formula of the specific product

Note: A U.S. Department of Agriculture number may appear on products registered prior to 1970.



In addition to helping identify a product, the EPA registration number allows poison control centers and pesticide hotlines to access more specific information in emergencies.

Other parts of labels may give information on product storage and disposal, and potential environmental or wildlife hazards.

All labels must be clearly visible and placed in a conspicuous location. For example, when a pesticide container is enclosed in an outer wrapper/package that obscures the container label, another label must be securely attached to the outer wrapper/package. When pesticides are transported in bulk—such as in cargo tanks or tank cars—a copy of the label must accompany the shipping papers. If the bulk container is stationary, a copy of the label, including directions for use, must be attached to the container near the discharge valve.

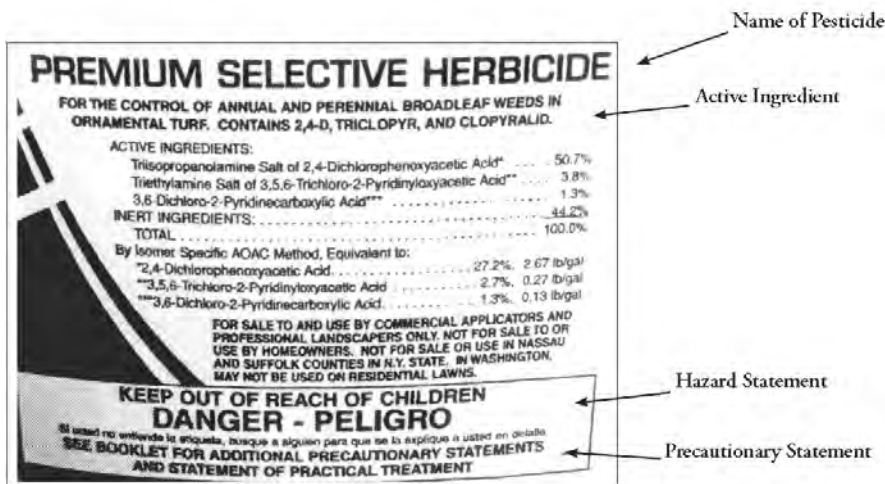



Page left blank intentionally.



## Lesson 2.3 - Emergency Response Guidebook

### Lesson Objectives<sup>1</sup>

#### NFPA® 472, 4.2.2

From a safe location, identify the hazmats/WMDs involved in each situation by name, UN/NA identification number, or type of placard applied.



- (2) Identify sources for obtaining the names of, UN/NA identification numbers for, or types of placards associated with hazmats/WMDs in transportation.
- (3) Identify sources for obtaining the names of hazmats/WMDs at a facility.

#### NFPA® 472, 4.2.3

Identify the fire, explosion and health hazard information for each material by using the current edition of the DOT Emergency Response Guidebook.

- (1) Identify the three methods for determining the guidebook page for a hazmat/WMD.
- (2) Identify the two general types of hazards found on each guidebook page.

#### NFPA® 472, 5.2.4(1)

Identify a resource for determining the size of an endangered area of a hazmat/WMD incident.



<sup>1</sup> NFPA 472® Standard for Competence of Responders to Hazardous Materials/Weapons of Mass Destruction, 2013 Edition.

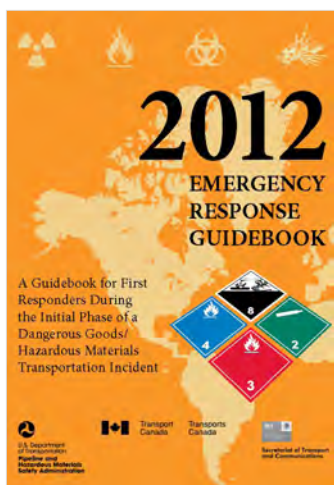

Before an emergency – become familiar with this guidebook!

## The Emergency Response Guidebook (ERG)

The ERG should be used by first responders (fire fighters, police and other emergency services personnel) who may be the first to arrive at the scene of a transportation incident involving hazardous materials/WMDs. It is designed to assist first responders in making defensive tactical decisions during the initial response phase of a hazardous materials/WMD emergency.

Although the ERG can assist you in making decisions about response actions, remember that it is only one source of information. **You should always check the recommended actions with at least two other sources, including your jurisdiction's standard operating procedures (SOPs).**

It is important that first responders use the current edition of the ERG (currently 2012) and be aware of the errata (errors that have been identified and the corrections) that has been discovered and released for the ERG. To find an electronic copy of the ERG, the ERG mobile app, the video about using the ERG and the errata, follow the link below.

<http://www.tc.gc.ca/eng/canutec/guide-menu-227.htm>

The ERG is primarily a guide to help first responders:

- Quickly identify the specific or generic classification of the material(s) involved in the incident
- Protect themselves and the general public during this initial response phase of the incident

The ERG was developed jointly by the:

- United States Department of Transportation (DOT)
- Transport Canada (TC)
- Secretariat of Communications and Transportation of Mexico (SCT)

### The ERG's Five Sections

1. **White.** Contains explanations, instructions, references and glossaries. Also contains pictures of placards (pages 6 - 7) and silhouettes of rail cars and highway transportation.
2. **Yellow.** Lists hazardous materials according to UN identification numbers.
3. **Blue.** Lists hazardous materials in alphabetical order.
4. **Orange.** Contains sets of two-page guides recommending response actions for hazardous materials.
5. **Green.** Contains tables of protective action distances (Table 1) and toxic inhalation hazard details. Chemicals in Table 1 with an asterisk (\*) are also listed in Table 3 which suggests protective action distances for different sized containers for six (6) common gases.





## Steps for Using the ERG

1. **Identify the material's identification number or name** from a placard, orange panel, shipping papers or package.
2. **Identify the 3-digit Guide number:**
  - **If you have the material's ID number**, locate it in the ID Number Index—yellow-bordered pages.
  - **If you know the material's name**, look it up in the Name of Material Index—blue-bordered pages.
  - **If the product poses a toxic inhalation hazard (TIH) is a chemical warfare agent or a dangerous water reactive material** (i.e., it produces toxic gas upon contact with water), it will be highlighted in green in either index.
    - ◆ **If there is no fire**, go directly to Table 1 (green-bordered pages), look up the ID number and name of the material and identify the initial isolation and protective action distances.
    - ◆ **If there is fire or a fire is involved**, also consult the assigned orange guide. If applicable, apply the evacuation information shown under public safety.
  - **If a reference to a guide cannot be found** and the incident is believed to involve hazmats:
    - ◆ **Use Guide 111** until additional information becomes available
    - ◆ **Use Guide 112**, explosives (other than 1.4 and 1.6).
    - ◆ **Use Guide 114**, explosives (1.4 and 1.6).
3. **Turn to the appropriate Guide** (orange pages). Read the entire guide carefully and follow its suggestions for response actions. The product's predominant hazard is listed first on these Guide pages (e.g., health or fire).

**If a placard is the only source of information**, turn to pages 6-7 and use the 3-digit guide next to the placard and proceed to numbered Guide in orange-bordered pages.

**As a last resort: if only the container can be identified**, consult the table of rail car and road trailer identification chart (pages 8-9). Information associated with these containers is for worst-case scenarios.

The ERG should be carried in every emergency response vehicle.

If the name in Table 1 is shown with "When Spilled In Water", these materials produce large amounts of Toxic Inhalation Hazard (TIH) gases when spilled in water. Some Water Reactive materials are also TIH materials themselves (e.g., Bromine trifluoride (1746), Thionyl chloride (1836), etc.). In these instances, two entries are provided in Table 1 for land-based and water-based spills. If the Water Reactive material is NOT a TIH and this material is NOT spilled in water, Table 1 and Table 2 do not apply and safety distances will be found within the appropriate orange guide.



## Guided Activity

Use the ERG to complete this individual activity.

1. Use the YELLOW pages to search by United Nations (UN) identification number. What material(s) is (are) listed for UN **1017**? To what Guide page would you turn to determine response actions for this material?

---

2. Use the BLUE pages to search by name of material. On what page in the ERG would you find **sulfuric acid**? What is its UN ID? To what Guide page would you turn to determine response actions for this material?

---

Use the BLUE pages to find and list the Guide pages for the following hazardous materials/WMDs.

Ammonia \_\_\_\_\_

Hydrogen Cyanide, Anhydrous, Stabilized \_\_\_\_\_

Ethanol \_\_\_\_\_

Sarin \_\_\_\_\_

Which of the chemicals above are also in Table 1? \_\_\_\_\_

Which of the chemicals above are also in Table 3?  
\_\_\_\_\_

3. There is a rail car of **ethylene oxide** that may release its contents. What is the initial isolation zone according to the ERG?

---



## Emergency Response Guidebook Quiz



Use the ERG to complete the quiz on this and the next two pages.

### Team 1 Assignment

1. What is the initial isolation zone and downwind protective action distance day and night when there is a small leak from a highway cargo tanker with the placard pictured below?



Isolation zone: \_\_\_\_\_  
Protective distance day: \_\_\_\_\_  
Protective distance night: \_\_\_\_\_

2. What is the primary hazard of the product with the ID number UN 1824?

---

3. What type of fire fighting foam should be used on a large spill fire involving the product in this highway cargo tanker placard?

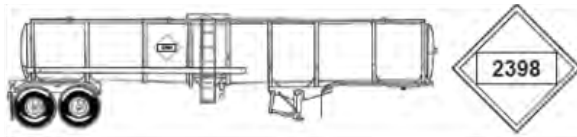

---

4. What type of protective clothing should be worn to handle a spill involving hydrofluoric acid solution?

---

*Activity continues on the next page.*



## Team 2 Assignment

5. In case of accidental eye contact with methanol, what actions should you take?

---

6. What are the recommended extinguishing agents for the materials with this UN number?



---

7. Which Guide number should be used for the product spilled from the 55-gallon drum in this picture?



---

8. What is the recommended evacuation distance if a truck load of explosives with this placard is involved?



---



### Team 3 Assignment

9. Identify the hazards and product name of the display found on an intermodal container.



---

10. What is the initial isolation for sarin, UN 2810, when used as a weapon?

---

11. Which Guide number should be used for emergency response information with a spill involving material with this placard?



---

12. If a highway cargo tanker is involved in a fire, what sights or sounds should cause an immediate withdrawal of emergency response personnel, according to this Guide page?

*Activity continues on the next page.*





## Team 4 Assignment

13. For the product methyl dichloroacetate, what unusual health information is listed?

---

14. What does the 'P' stand for when you look up styrene monomer, inhibited?

---

15. You arrive on the scene and find a worker down on a loading dock near a 55-gallon plastic drum. He is conscious and yelling, "Help me!" As you continue to survey the scene, you observe a portion of the DOT label. It is white on top and black on the bottom.

What type of material is this? Wearing your SFPC and SCBA, would you assist this individual?

---

16. You are returning to your station from an EMS response and come upon a vehicle accident that has just happened. A car has rear-ended a small delivery truck. The rear cargo door of the truck has opened as a result of the crash and a cardboard box has rolled out across the hood of the car and through the windshield, bursting open and contaminating the driver of the car. As you approach the vehicle, you observe a blue DOT placard on the truck and a blue DOT label on the box. There is only minor damage to the vehicle, but the driver cannot extricate himself from the car and is screaming, "I'm burning!"

What type of material is this? Wearing your SFPC and SCBA, would you assist this individual?

---





## Lesson 2.4 - NIOSH Pocket Guide and Chemical/Physical Properties

### Lesson Objectives<sup>1</sup>



#### NFPA® 472, 5.2.2 (8)

Describe the properties and characteristics of (a) alpha, (b) beta, (c) gamma and (d) neutron radiation.

NFPA® 472, 5.2.3(1)(a) Match the following chemical/physical properties with their significance and impact on the behavior of a container and its contents:

- i. Boiling point
- ii. Chemical reactivity
- iii. Corrosivity (pH)
- iv. Flammable (explosive) range [lower explosive limit (LEL) and upper explosive limit (UEL)]
- v. Flash point
- vi. Ignition (autoignition) temperature
- vii. Particle size
- viii. Persistence
- ix. Physical state (solid, liquid, gas)
- x. Radiation (ionizing and non-ionizing)
- xi. Specific gravity
- xii. Toxic products of combustion
- xiii. Vapor density
- xiv. Vapor pressure
- xv. Water solubility

#### NFPA® 472, 5.2.3 (8)(a)

Identify the health hazards associated with alpha, beta, gamma and neutron radiation.

#### NFPA® 472, 5.2.4(5)

Describe the impact that time, distance, and shielding have on exposure to radioactive materials specific to the expected dose rate.

Emergency responders must understand some of the basic chemical and physical properties of the materials they respond to in order to complete a safe hazard and risk assessment at any incident. This understanding can help with:

- Identifying, choosing and planning response actions
- Anticipating the effects of other actions and reactions involving rising temperature, impinging flames, dangerous chemical combinations, etc.
- Judging whether you can be adequately protected from exposure



<sup>1</sup> NFPA 472® Standard for Competence of Responders to Hazardous Materials/Weapons of Mass Destruction, 2013 Edition.



## NIOSH Pocket Guide To Chemical Hazards

The **NIOSH Pocket Guide** helps first responders initially weigh risks and benefits of entry at a hazardous materials scene based on chemical and physical properties of the probable product(s) involved. The NIOSH Pocket Guide provides descriptions of many chemicals along with their properties and effects, as well as recommended precautions and response guidance. The data is consolidated by using abbreviations and codes.

The NIOSH Pocket Guide is intended as a source of general industrial hygiene information on several hundred chemicals/classes for workers, employers and occupational health professionals. It provides key information and data in an abbreviated tabular form for 677 chemicals or substance groupings commonly found in the work environment.

The NIOSH Pocket Guide does not contain an analysis of all pertinent data. It does not make recommendations (like the ERG) for handling an emergency involving a substance. It does provide information that a responder may use to help predict the behavior of a substance. The information in the NIOSH Pocket Guide should help users recognize and control occupational chemical hazards.

As with most references, an extensive set of instructions and explanations is included. It is highly recommended that these instructions and explanations be thoroughly reviewed before making decisions based on the information found in the Guide.



The NIOSH Pocket Guide contains information on:

- Chemical names, synonyms and trade names
- Conversion factors
- Chemical Abstracts Service (CAS), Registry of Toxic Effects of Chemical Substances (RTECS) and DOT numbers
- Physical description of chemicals:
  - Chemical and physical properties
  - Incompatibilities and reactivities
- NIOSH Recommended Exposure Limits (RELs)
- OSHA Permissible Exposure Limits (PELs)
- NIOSH Immediately Dangerous to Life and Health values (IDLHs) (documentation for those values)
- Measurement methods
- Personal protection and sanitation recommendations
- Respirator recommendations
- Information on health hazards including route, symptoms, first aid and target organ information

There are two (2) chemicals listed per page. The 677 substances are listed by name, alphabetically (used in 29 CFR 1910.1000). **There is also a list of synonyms and trade names located in the back of the Guide (page 383).** If you cannot find a chemical, a check of the Chemical, Synonym and Trade Name Index may help you find the page number where the substance appears.



## Exposure Limits

Governmental organizations use the following abbreviations for exposure limits. OSHA stipulations are a matter of law. Exposure limit abbreviations such as these appear in references and on safety data sheets (SDSs). These definitions are important, e.g., the IDLH value may help determine if a victim who has been inside a tank for a long time is likely to survive (viable).

OSHA (Occupational Safety and Health Administration)		
PEL	<b>P</b> ermissible <b>E</b> xposure <b>L</b> imit	Average concentration that must not be exceeded during an 8-hour work shift of a 40-hour work week
STEL	<b>S</b> hort <b>T</b> erm <b>E</b> xposure <b>L</b> imit	15-minute exposure limit, separated by a 1-hour break, no more than 4 times per day that should not be exceeded
NIOSH (National Institute for Occupational Safety and Health)		
REL	<b>R</b> ecommended <b>E</b> xposure <b>L</b> imit	Average concentration limit recommended for up to a 10-hour work day during a 40-hour work week
IDLH	<b>I</b> mmediately <b>D</b> angerous to <b>L</b> ife or <b>H</b> ealth	Maximum concentration from which a person could escape (in the event of respirator failure) without permanent or escape-impairing effects
ACGIH (American Council of Governmental Industrial Hygienists)		
TLV-TWA	<b>T</b> hreshold <b>L</b> imit <b>V</b> alue – <b>T</b> ime <b>W</b> eighted <b>A</b> verage	Average concentration limit for a conventional, weighted average 8-hour work day and a 40-hour work week that should not cause adverse effects for nearly all workers
TLV-STEL	<b>TLV</b> – <b>S</b> hort <b>T</b> erm <b>E</b> xposure <b>L</b> imit	15-minute exposure limit that should not occur more than 4 times during any given work day; should be 60 minutes between successive exposures
TLV-C	<b>TLV</b> – <b>C</b> eiling	Concentration that should not be exceeded during any time of working exposure

## Key Points

If a chemical has data listed for any of the exposure limit terms, the values are small (ppm). The smaller the exposure limit, the more toxic the material.

1% = 10,000 parts per million (ppm)

1 ppm = 1,000,000 mm in 1 km  
(1 inch in 15.78 mile)

1 ppm = 1¢ in \$10,000.00

## Immediately Dangerous to Life or Health (IDLH)

is a condition that poses a threat of exposure to airborne contaminants when that exposure is likely to cause death or immediate or delayed permanent adverse health effects, or prevent escape from such an environment.

As a safety margin, IDLH values are based on effects that might occur as a consequence of a 30-minute exposure. However, the 30-minute period was NOT meant to imply that workers should stay in the work environment any longer than necessary; in fact, EVERY EFFORT SHOULD BE MADE TO EXIT IMMEDIATELY!



## States of Matter

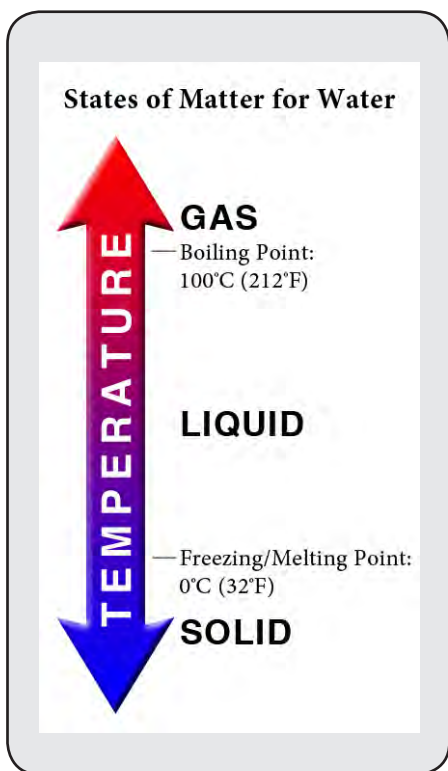

All elements exist in nature in one of three states: solid, liquid or gas. Substances can change from one state to another as changes occur in temperature, pressure or both. **A toxic substance is often more hazardous in the gaseous state than in the liquid state because it is easier to inhale as a gas and more difficult to control.** Emergency responders must recognize these differences, because a change in a material's physical state is likely to:

- Affect the degree of hazard posed by the material
- Influence the tactics needed to control the situation

Temperature is of paramount importance to both fire fighting and hazardous materials response because it changes a product's physical state. Temperature can affect all three states of matter.

Three different scales are used to measure temperature: Celsius (C), Fahrenheit (F) and Kelvin (K). The first two scales are in common use and appear in reference textbooks and chemical databases. The Kelvin scale is used primarily in technical and scientific settings.

### Two Most Common Temperature Scales

#### Celsius:

To convert Celsius to Fahrenheit, use this formula:

$$37^{\circ}\text{C} \times 9/5 + 32 = 98.6^{\circ}\text{F}$$

#### Fahrenheit:

To convert Fahrenheit to Celsius, use this formula:

$$(98.6^{\circ}\text{F} - 32) \times 5/9 = 37^{\circ}\text{C}$$

Reference Points	Celsius	Fahrenheit
Boiling point of SULFUR TETRAFLUORIDE	-40°	-40°
Freezing point of water	0°	32°
Normal room temperature	20°	68°
Normal body temperature	37°	98.6°
Boiling point of water	100°	212°



## Solids

**A solid is a substance that retains a definite size and shape under normal conditions.** Solids include dusts and powders. Solids can be affected by the wind, water and gravity.

The **particle size** of a solid is significant as it influences how long a solid will remain suspended in air—**larger particles will settle more quickly than smaller particles.** Particle size is usually measured in microns ( $\mu$ ) (one micron equals one millionth of a meter). Some common particle sizes include: the width of a human hair can range from 18 - 80  $\mu$ , while weapons grade anthrax spores range from 1 - 3  $\mu$ .

When most solids melt, they change to liquid. The temperature at which this occurs is the **melting point.**

## Liquids

**A liquid is a substance that flows and has a specific volume but takes the shape of its container.** The temperature at which a liquid freezes is called the **freezing point.** The temperature at which a liquid changes to a gas is its **boiling point.** At this point, vaporized liquid rises to the surface and enters the surrounding air as vapor. Different liquids reach their boiling points at different temperatures.

## Gases

**A gas is a substance that expands or compresses readily and has no independent shape or volume.** Gases may condense to form liquids when the gas is cooled to, or below, its boiling point. (Depending on the pressure, gases can also turn into solids.) Gases may also be liquefied by exerting pressure on the gas. Materials that exist as gases have boiling points lower than 68°F and vapor pressures greater than that of atmospheric pressure.



## Vapor Pressure

**Vapor Pressure (VP) is a measure of the force created when a liquid evaporates.** Evaporation is the process of changing from a liquid to a gas state. Vapor pressure is often expressed in millimeters of mercury (mmHg or simply mm), but other units such as atmospheres (atm) or pounds per square inch (psi) may also be used.

$$760\text{mmHg} = 1 \text{ atm} = 14.7 \text{ psi} = 1 \text{ bar}$$

The higher the vapor pressure, the faster the evaporation. **Products with high vapor pressures are more volatile than those with low vapor pressures and will give off more vapor.** For example:

Vapor pressures of select materials at 68°F	
Rock	0 mmHg
Water	18 mmHg
Acetone	180 mmHg
Acetylene	33,592 mmHg

States of matter and vapor pressure	
Solids	VP is almost always equal to, or near, 0 mmHg
Liquids	VP is less than 760 mmHg
Gases	VP is equal to, or greater than, 760 mmHg

VP is measured at 68°F. Temperatures greater than 68°F will cause products to evaporate quicker than usual. As temperature increases, the VP of a liquid also increases. If the temperature of the product increases enough, the VP rises until it reaches atmospheric pressure (760 mmHg or 1 atm). When it reaches its boiling point, the liquid becomes a gas.

The effect of temperature can be demonstrated by comparing vapor pressures:

Water at 212°F = VP of 760 mmHg  
(rapid evaporation at its boiling point)

Water at 122°F = VP of 93 mmHg

Water at room temperature = VP of 18 mmHg

Water at 32°F = VP of around 0



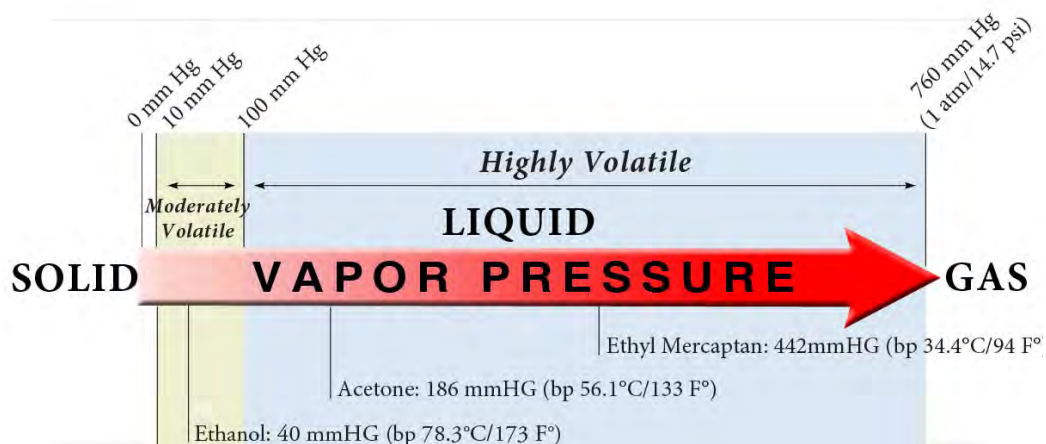

The vapors of a liquid burn—rather than the liquid itself. Vapor pressure indicates how quickly a flammable liquid vaporizes, how quickly it reaches the lower explosive limit.

Vapor pressure also indicates how readily a chemical will contaminate the air. This is important because inhalation is the primary route of exposure.

Liquid	Vapor Pressure	Boiling Point
Water	18 mmHg	212°F
Ethanol	40 mmHg	173°F
Acetone	186 mmHg	133°F
Ethyl mercaptan	442 mmHg	94°F



## Gas Compression

Compared with other states of matter, **gases are the least dense and most difficult to contain or control once released.** They can be reduced in volume by increasing pressure (or decreasing temperature) to force the gas into a smaller volume. Certain gases are classified as **cryogenic** because of their low temperatures. **DOT defines cryogenic gases as those with boiling point temperatures at or less than -130°F.**

Unlike other compressed gases, a cryogenic gas can be particularly problematic during a fire because of its extreme coldness coupled with large expansion ratios. Cryogenic containers are equipped with safety relief devices which allow built-up pressure to be vented. **Applying water may freeze these devices and cause the container to rupture.**

Compressed gases can be dangerous because of their expansion ratios. When a container fails, it can release the entire quantity of gas it is intended to contain. The expansion ratio refers to a volume of the gas compared to its volume as liquid. For example, liquefied natural gas (LNG) has an expansion ratio of 1 to 600. This means that one cubic foot of LNG will expand to 600 cubic feet of gas if released from its container.

Liquefied Gas	Gas Expansion Ratio
Liquefied oxygen (LOX)	860 times
Liquefied ammonia (NH <sub>3</sub> )	800 times
Liquefied helium-3 (He)	757 times
Liquefied nitrogen (N <sub>2</sub> )	696 times
Liquefied natural gas (LNG)	600 times
Liquefied carbon dioxide (CO <sub>2</sub> )	553 times
Liquefied chlorine (Cl)	460 times
Propane	270 times



## Boiling Point

The boiling point of water is 212°F. As the temperature of a liquid increases, the molecules of a liquid gain energy and, as a result, move around more. At the boiling point of the liquid, these molecules enter the surrounding air as vapor. The higher a chemical's vapor pressure, the quicker it boils, producing more and more vapors.

The boiling point of a liquid is affected by atmospheric pressure, that is, the pressure the atmosphere exerts on the liquid. Boiling point is measured at one standard atmosphere, which equals 760 mmHg on a barometer, or 14.7 psi (at sea level). At levels above sea level, atmospheric pressure decreases, resulting in quicker vaporization of liquids.

At its boiling point, 212°F, the vapor pressure of water is equal to atmospheric pressure (760 mmHg). Boiling point is defined technically as the temperature at which a liquid's vapor pressure equals atmospheric pressure.

When entering the gas state, a liquid product gives off many times its original volume in vapor. Think of water in a teapot, heating up and converting into steam. If the product were contained inside a closed vessel with no mechanism for ventilation, the vapors generated as the liquid heats exert increasing pressure on the vessel. Over-pressurization can lead to catastrophic container failure.

Low vapor pressure = high boiling point

High vapor pressure = low boiling point

### Boiling Point

Boiling point is the temperature at which a liquid's vapor pressure equals atmospheric pressure.

When the temperature of the product is below the boiling point, the material is a liquid; when the product is above its boiling point, it is a gas.

### Boiling Point Example 1

In a car radiator, the cooling system is pressurized so the water it contains can absorb heat beyond its normal boiling point (212°F). When a car overheats, steam spews out when the radiator cap is removed because the water, which is under pressure and above its normal boiling point, is exposed to normal pressure and boils off instantly.

### Boiling Point Example 2

A pressure cooker is a sealed container that is pressurized by water-generated steam in order to heat its contents beyond 212°F, and thereby speed up the cooking process.



### Additional Information

Additional information related to BLEVEs is available in the ERG, beginning on page 364.

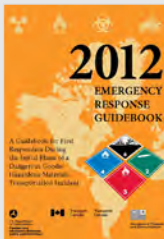

# **B**oiling **L**iquid **E**xpanding **V**apor **E**xplosion

A BLEVE occurs if a container holding a pressurized liquefied gas fails catastrophically. Catastrophic failure of the vessel is followed by the explosive release of boiling liquid and expanding vapor.

The BLEVE is a physical explosion where the hazards are blast and projectiles. It should be noted that a commodity does not have to be flammable for a BLEVE to occur.<sup>1</sup>

The following is the process that results in BLEVEs.

1. When heat (e.g., flame) is added to liquefied gases or liquids in closed containers, their vapor pressure will increase.
2. An increase in vapor pressure will increase the material's boiling point (the temperature at which a liquid's vapor pressure equals atmospheric pressure).
3. An increase in the material's boiling point will allow the liquid to rise in temperature, thereby increasing vapor pressure, thereby increasing pressure, thereby increasing boiling point, etc.
4. The liquid level in the container will drop as more material is converted to vapor and/or relief systems operate and dump excess pressure and product into the environment.
5. The lower level of heat absorbing liquid in the container exposes the container to thermal stress, and container pressure may be exceeding design limits.
6. The container may fail and when it does, the material in the container is now at 760 mmHg (1 atm), but its temperature is much higher than the boiling point at 1 atm.
7. The material, now much higher than its boiling point, flash boils—it all tries to turn into a vapor/gas instantly.
8. This creates a large increase in pressure which, combined with the release of the container pressure, produces a great deal of force—capable of propelling large pieces of the container thousands of feet.
9. If the material is flammable and encounters an ignition source, it will ignite, producing even more pressure and significant thermal hazards.

Additional information on BLEVEs is provided in the chemical reactivity section of this lesson.

<sup>1</sup> BLEVE: Response and Prevention, Birk, A. M., Queens University, Department of Mechanical Engineering, Kingston, ON, Canada (September 1995), page 5.



## Persistence

Persistence is a military term that describes **the length of time a chemical agent will remain effective in the environment after it has been dispersed**. It is directly related to volatility, the tendency of a substance to vaporize, and vapor pressure—as volatility and vapor pressure increase, persistence decreases.

The rule of thumb to remember is—**a low boiling point plus high vapor pressure produces less persistence** (material lingers or stays in the area longer).

The military's desire for persistent agents explains why many military chemicals, such as mustard, vaporize slowly compared to many industrial chemicals.





## Vapor Density

Vapor density is a measure of the weight of a gas compared to an equal volume of air. **Vapor density is important when sampling the air, identifying safe areas during an emergency, and predicting how a gas will spread.**

- Air has a vapor density of one (1).
- Air has a molecular weight of 29.
- There are some common substances with vapor densities less than one—lighter than an equal volume of air. Being lighter than air, they rise through it.
- All liquids and many gases have vapor densities greater than one—heavier than an equal volume of air. They will sink in air, and often collect in low-lying areas or close to the ground.

In order to determine whether a gas or vapor has a vapor density less than air, the molecular weight of the chemical can be used. The molecular weight is the mass that is assigned to atoms or molecules that make up a chemical. **This unit of measure may be found in references such as the NIOSH Pocket Guide to Chemical Hazards.** In the NIOSH Pocket Guide, gases will have a notation for “R<sub>GasD</sub>” (relative gas density)—this is the vapor density as compared to air.

Liquids will not have R<sub>GasD</sub>. To determine the relative density of vapors (material that evaporates from liquids) compare the molecular weight (MW) of the material to that of air – 29. **Materials with MW greater than 29 will tend to sink in air, and materials with MW less than 29 will tend to rise.**



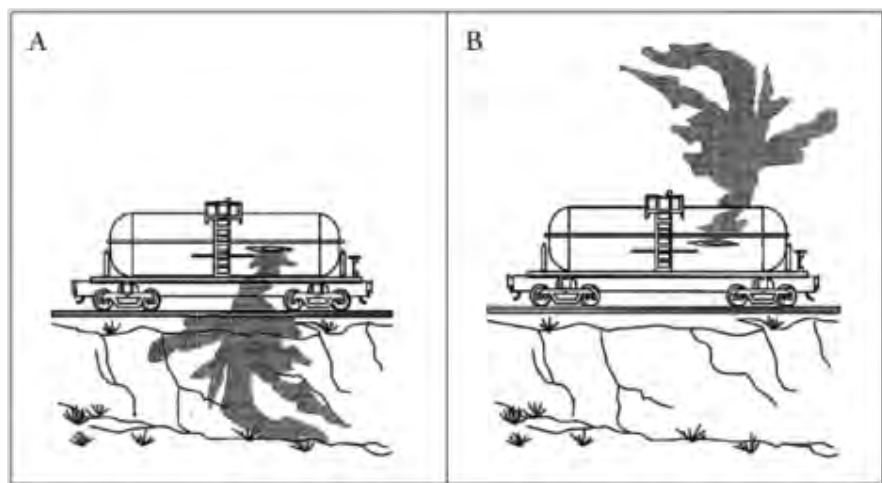

- A. Chemical sinks if: vapor density is greater than 1, and molecular weight is greater than 29.
- B. Chemical rises if: vapor density is less than 1, and molecular weight is less than 29.

Commonly Encountered Lighter than Air Gases (i.e., having a vapor density < 1)

Gas	Approximate Vapor Density	Molecular Weight
Hydrogen	0.07	2.02
Helium	0.14	4.0026
Hydrogen Fluoride	0.69	20.0
Hydrogen Cyanide	0.93	27.03
Methane	0.55	16.043
Ethylene	0.96	28.01
Diborane	0.96	28.01
Carbon Monoxide	0.96	28.01
Ammonia	0.59	17.03
Neon	0.69	20.18
Nitrogen	0.96	28.01
Acetylene	0.90	26.04

### Vapor Density

A measure of the weight of a gas compared to an equal volume of air



## Specific Gravity

### Key Point

Relate that the concept of specific gravity is important for first responders, because a chemical that is lighter than water will float while the heavier water sinks to the bottom.

Floating products are easier to capture and contain than sinking ones. In order to keep the chemical away from the public, emergency responders use specific tactics to keep a floating product from spreading further. (They might place a dike at the source so no more product would enter the water; put some hay on it to act as a sponge; or build a dam or place a boom in a low-lying ditch to siphon floating product off the top.)

Specific gravity is a concept used to measure the weight of solids and liquids in comparison to an equal volume of water.

- Water has a specific gravity of one (1).
- A solid or liquid that is heavier than an equal volume of water has a specific gravity greater than one. This substance would sink in water.
- A solid or liquid that is lighter than an equal volume of water has a specific gravity less than one. This substance would float in water.

Specific gravity has no unit of measure. It is only a relative value (relative to water). Specific gravity can also help determine response strategy (for example, the type of dam or dike that is best suited to control a liquid spill in water).

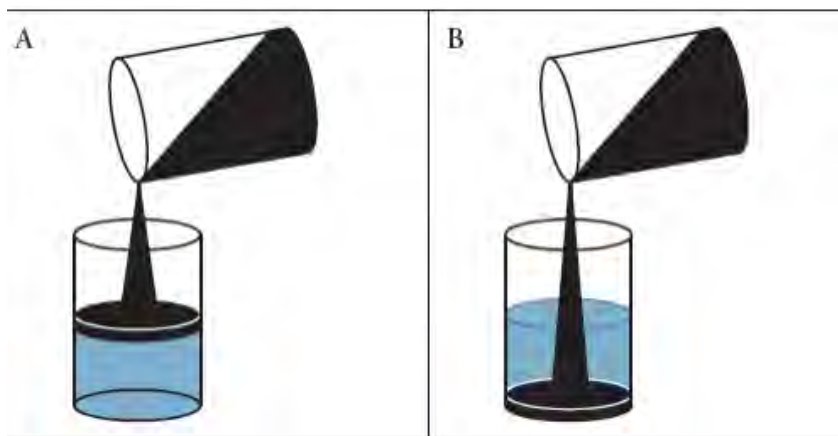

A. Specific gravity less than one

B. Specific gravity greater than one

### Examples of Specific Gravity

Examples of materials that have a specific gravity  $> 1$ :

- Sulfuric acid
- Hydrogen peroxide

Examples of materials that have a specific gravity  $< 1$ :

- Gasoline
- Most hydrocarbons



## Water Solubility or Miscibility

Solubility or miscibility refers to the degree that one substance mixes with another substance. In such a mixture, the substance present in greater amount is called the solvent. Water can be a solvent, although the term usually relates to petroleum-based chemicals. In general, the substance present in lesser amount is called the solute.

### Examples of Water Solubility

Examples of materials that are soluble in water:

- Methyl alcohol
- Acetone

Examples of materials that are insoluble in water:

- Benzene
- N-Hexane

### Key Point: Water Solubility

The attribute of miscibility is important to first responders, because if a chemical has the ability to mix with water, it will sink below the water line, making it impossible to soak up, dam up or divert it from further spreading and affecting the public.



## Flammability

### Flash Point

Flash point is the minimum temperature at which a liquid releases enough vapors to create an ignitable mixture near the surface of the liquid.

According to DOT, a flammable liquid is a liquid with a flash point less than 141°F. A combustible liquid is one with a flash point above 141°F and below 200°F.

**Flammable liquids with high vapor pressures tend to be more dangerous than those with low vapor pressures.** They more readily form ignitable mixtures, becoming subject to inhalation.

### Definitions of Flash Point

Entity	Flammable	Combustible
DOT	≤ 140°F	141 - 200°F
NFPA	≤ 100°F	101 - 200°F

### Fire Point

Fire point is the temperature at which a material will continue to burn. Usually a material's fire point is a few degrees higher than its flash point.

### Ignition Temperature

References may list the ignition temperature of a chemical (also called the **auto-ignition temperature**). This is the temperature at which a material starts to burn without an ignition source. At this temperature, gases or vapors are consumed in fire as rapidly as they are formed, and the material continues self-sustained combustion. Many flammable solids have ignition temperatures greater than 400°F, much higher than flash points of flammable liquids. One notable exception is phosphorus (white or yellow), with an ignition temperature of 86°F. Phosphorus is pyrophoric (ignites in air) and is commonly shipped immersed in water.



## Flammable (Explosive) Range

The explosive—or flammable limit—refers to the concentration of a flammable vapor or gas in the air.

Below the lower explosive limit (LEL), a mixture is too lean to ignite. There are not enough flammable vapors in the air to ignite. Above the upper explosive limit (UEL), the highly concentrated mixture is oxygen deprived, and therefore too rich to ignite.

Between the LEL and UEL, the mixture is explosive or flammable.

**Remember that sources of electricity such as lights, motors, traffic and even static electricity can ignite mixtures between the LEL and UEL.**

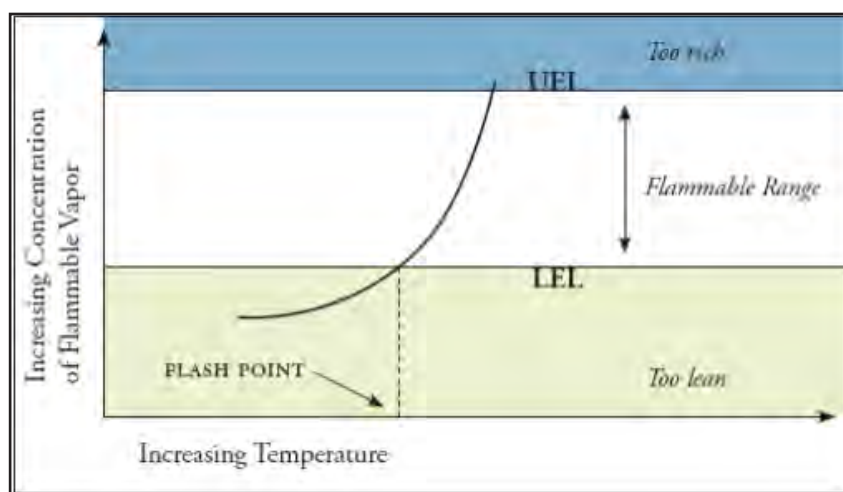

Imagine responding to a liquid chemical spill on an asphalt road surface involving a material with a boiling point of 100°F. If the air temperature is 80°F, the asphalt may very well register 100°F or higher. Because the spilled chemical is near its boiling point, it will be evaporating very quickly. The concentration of vapors in the atmosphere will be increasing. These vapors may burn (not the liquid itself). Vapors from a chemical will trail the initial product spill or release. A spark could set this entire vapor path aflame, endangering everything along the way. Static electricity, even sparks from a car's ignition, can be sufficient to ignite a fire from these vapors.



## Corrosivity

### Reference

Acids are materials which donate protons (H+), and bases are acceptors of protons (OH-). The more ionized the material is, the stronger the acid or base. In general, the strength of an acid is inversely proportional to the strength of the H+ bond.

Concentration refers to the amount of available H+ or OH- in a liquid, based on weight. For example, you may have solutions of both sulfuric acid and acetic acid with similar strengths but dissimilar concentrations.



Is this product an acid or a base?

Corrosive materials are characterized by the extent to which they contain either acids or bases. The pH scale indicates a material's corrosive level. It ranges from 0 to 14, with 7 (the midpoint) being neutral. Values lower than 7 indicate increasing acidity, while those higher than 7 indicate increasing basicity.

The pH scale is a logarithmic scale in which two adjacent values increase or decrease by a factor of 10. The difference in acidity from pH 6 to pH 7 is small, while the difference from pH 3 to pH 4 is greater, and the difference in acidity between pH 1 and pH 2 is greater yet. The difference between pH of 0 and 1 is even greater, with pH of 0 being 10,000,000 times more acidic than 1.

When dealing with acids and bases, it is also important to obtain information about the concentration or strength of the acid or base. A high concentration of a weak acid can be equally as dangerous as a low concentration of a strong acid.

Both acids and bases can cause injury. Materials with a low or high pH are the most hazardous; any highly concentrated acids or bases should be carefully assessed before action is taken. **Base chemical burns can be the most devastating of all eye injuries.**

pH scale values	
Relationship to neutral pH	Range of pH values
10,000,000 times more acidic	0
1,000,000 times more acidic	1
100,000 times more acidic	2
10,000 times more acidic	3
1,000 times more acidic	4
100 times more acidic	5
10 times more acidic	6
neutral	7
10 times more basic	8
100 times more basic	9
1,000 times more basic	10
10,000 times more basic	11
100,000 times more basic	12
1,000,000 times more basic	13
10,000,000 times more basic	14





## Chemical Reactivity

Chemical reactions result when two or more substances combine to form new chemicals which cause energy to be absorbed or released. Combustion, polymerization and ionization are examples of chemical reactions.

Some chemical reactions take place in an instant, like the reaction of an ignited stick of dynamite. However, other reactions take months (for example, the length of time required for a nail to rust). The rate of reaction depends on various factors:

- **Temperature:**
  - Increasing temperature usually speeds reactions.
- **Concentration:**
  - Increasing the concentrations of the reacting materials usually increases the rate of reaction.
- **Presence of catalysts:**
  - Catalysts increase the rate of chemical reactions, but are not themselves affected by the reaction.

In addition to the factors listed above, the physical and chemical properties of reactive materials can influence reactions. For example, gases and vapors react more readily than liquids and solids, and highly reactive materials can spontaneously explode or ignite when exposed to some other substance.

Some materials react when exposed to water. For example, sodium metal is extremely water-reactive and may explode if it comes in contact with water. It is stored dry or in mineral oil or kerosene. Air-reactive materials, such as phosphorus, react when exposed to air. A related term, pyrophoric, is used to describe a material (liquid or solid) that spontaneously ignites in air, at or below 130°F.

## Polymerization

**Polymerization is the process of single chemical units (monomers) combining to form larger chemical units (polymers).** A monomer represents a link in a chain; all the units linked together form a polymer chain. Ethylene (a monomer) can polymerize to form polyethylene (a polymer). Inhibitors are added to materials to maintain their stability during shipment. Should an inhibitor fail, the risk of polymerization increases. **Events that can cause inhibitors to fail include: exposure to heat, time lapse, and vessel or load contamination. Polymerization in a closed container can cause an explosion.**



## Explosion

Explosions are sudden chemical reactions that release tremendous energy. Explosions can be classified by how quickly gases are created. Force is created when gases expand rapidly. The more gas created, the greater the force. When high explosives such as dynamite detonate, they release gas quickly. Low explosives, such as ignited loose black powder, typically create gas at a slower rate, producing less force than dynamite.

## More on BLEVEs

Flammable gases are particularly hazardous when transported or stored in their liquefied form because there is added potential for this liquid to create a **BLEVE**. A vapor explosion could be caused by a ruptured container of liquefied flammable gas, and could then result in an uncontrollable fire.

For example, a BLEVE can occur when a container is exposed to fire, and the flames impinge on the tank shell. The liquid inside the tank begins to boil and vaporize. As vapor is vented from the relief valve, the level of liquid drops. After time, the relief valve is unable to sufficiently vent the vapors. Heat and pressure build inside the tank, causing the container to weaken, tear and/or rupture. When the released product hits the atmosphere, it triggers an explosive instantaneous ignition.

## BLEVE Lessons Learned

Fact	Response guidance
Relief valves may not be able to relieve enough pressure to avoid a BLEVE.	If a vertical torch shoots up from the relief valve and a shrieking sound can be heard, a BLEVE is imminent; personnel should be out of the area.
Attempts to cool an LP-gas container to prevent a BLEVE requires a lot of continually-applied water.	A cooling effort will probably fail without an immediate, steady, substantial water supply.
According to NFPA® 58, above ground piping and valves for propane are to be protected from physical harm with fencing.	Protective fencing should be verified within community pre-incident planning efforts.
The decision to protect exposed buildings where there is no threat to human life has imperiled—if not taken—the lives of many fire fighters.	Stage at a distance when flames are impinging on a liquefied gas tank. Think in terms of risk-benefit and do not risk being caught in a BLEVE to save property.

Source: Wolf, A. "BLEVE Kills Two," NFPA Online, February 17, 2004, <http://www.nfpa.org/Research/FireInvestigation/Articles>.



## Oxidation

Oxidizers can make a fire burn hotter and faster or make materials that are not normally flammable burn. Their presence may result in explosions. Some oxidizers are unstable or very reactive. On its own, oxygen is nonflammable. However, when combined with other materials (even nonflammable protective clothing) it becomes a powerful oxidizer, capable of dramatically accelerating combustion. Oxidizers often continue to burn even when sources of air are removed from the fire because they provide their own oxidizing capability, so they do not need a continual air supply.

Materials posing oxidation hazards include:

- Inorganic peroxides
- Organic peroxides
- Chlorine
- Chlorates
- Perchlorates
- Iodine
- Fluorine
- Bromine





## Radiation

**Radiation** is the emission of electromagnetic energy, in either non-ionizing or ionizing form.

### Non-Ionizing Radiation

**Non-ionizing radiation** has enough energy to move atoms but not enough to alter them chemically. Most routine exposures are to non-ionizing radiation. Non-ionizing radiation is present in soil, the sun, fluorescent lights, microwave ovens and television/computer monitors.

### Ionizing Radiation

The type of radiation that poses a threat to humans is **ionizing radiation**, which is capable of removing electrons from atoms and damaging living cells and the DNA of those cells. Examples of sources of ionizing radiation include x-rays, survey equipment, medical diagnostic isotopes and radioactive materials. Ionizing radiation may be in the form of alpha, beta and neutron radiation, as well as gamma and x-rays.

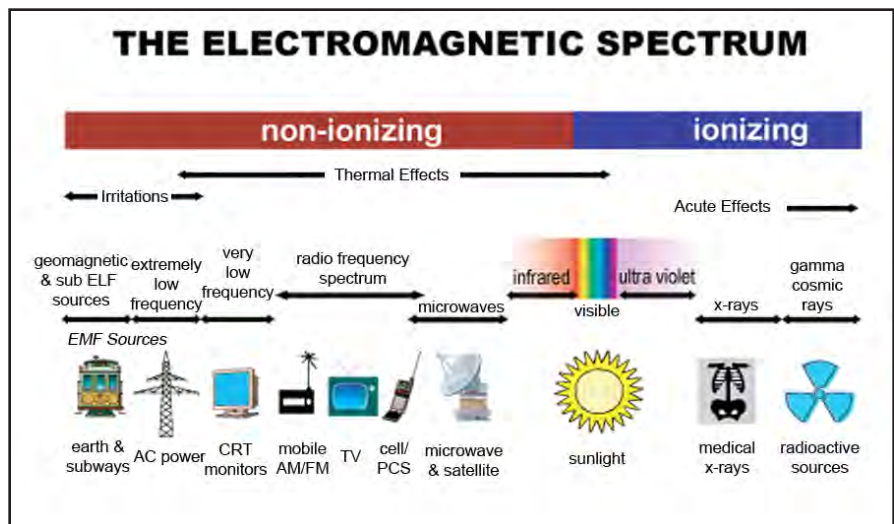

### Alpha Particles

**Alpha radiation** can only travel a short distance from its source (usually a few centimeters in air), so it can be deflected by skin, a thin film of water or a sheet of paper. The health effects of alpha particles depend on how exposure takes place. External exposure (external to the body) is of far less concern than internal exposure, because alpha particles lack the energy to penetrate the outer layer of dead skin. Internally, alpha particles can be very harmful. If alpha emitters (radioactive materials) are inhaled, ingested (swallowed) or absorbed into the blood stream, sensitive living tissue may be exposed to alpha radiation.



## Beta Particles

The energy from **beta radiation** travels farther than alpha particles—most will be absorbed after traveling about a meter. Although beta particles are more penetrating than alpha particles—the particles can penetrate about 1½ inches of wood and through ½ inch of human skin.

Beta particles are less damaging over equally traveled distances than alpha particles. They travel considerable distances in air, but can be reduced or stopped by a layer of clothing or by a few millimeters of a substance such as aluminum. Some beta particles are capable of penetrating the skin and causing radiation damage, such as serious skin burns. Beta particles can also damage the eyes. However, as with alpha-emitters, beta-emitters are most hazardous when they are inhaled or ingested.

## Gamma Rays

**Gamma rays** often accompany the emission of alpha or beta particles from a nucleus. Gamma rays carry higher energy and are more penetrating than alpha or beta particles. These rays are only blocked with dense shielding, such as several inches of lead or several feet of concrete. Gamma rays are a radiation hazard for the entire body. While gamma rays can easily pass completely through the human body, a fraction will always be absorbed by tissue.

## Neutron Particles

**Neutron radiation** is a form of high-speed particle energy. Neutron radiation is most commonly found in nuclear reactors or result from nuclear detonations. Neutrons carry no electrical charge and ionize matter by direct collision with electrons. Neutrons are extremely penetrating to most materials and can impart a great deal of energy—causing ionization (and damage). Neutron particles can affect all the organs. Water or materials containing water (concrete) are good shielding.



## Time, Distance and Shielding

### As Low As Reasonably Achievable

**ALARA (as low as reasonably achievable)** is a principle of radiation protection that requires that exposures to ionizing radiation to be kept as low as reasonably achievable, economic and social factors being taken into account. The protection from radiation exposure is ALARA when the expenditure of further resources would be unwarranted by the reduction in exposure that would be achieved. Time, distance and shielding (TDS) does not require new or additional equipment to reduce potential exposures and can be used to achieve ALARA. In short, it can be defined as follows.

### Time

Responders should strive to minimize the amount of time spent in hazardous environments (chemical, radiological, biological, etc.), while performing the mission or task assigned. Minimizing time in or around a source of radiation will minimize the dose to the responder, and effectively reduce the overall dose received during an incident.

### Distance

Responders should approach all incidents from a distance that provides adequate protection, while allowing for scene size-up, evaluation of mission requirements, and the eventual mission execution. Distance plays a key factor in reducing radiological exposures. The inverse square law is one means to calculate probable exposure rates from unshielded point sources of gamma radiation.

### Shielding

Responders should recognize shielding as a viable means to reduce dose. Although specialized shielding will not normally be available during initial response to an incident, shielding can play a key role in dose reduction. Responders should approach an incident using shielding from buildings, vehicles, earth barriers and other potential sources. In incidents involving transportation packaging and radiation devices, responders can approach from the shielded side of a source of radiation and perform missions with a significantly reduced dose potential.

**ALPHA Particles**  
Stopped by sheet of paper



**BETA Particles**  
Reduced or stopped  
by a layer of clothing  
or by a few millimeters  
of aluminum



**GAMMA  
and X-Rays**  
Stopped by several feet  
of concrete or a few  
inches of lead



**Neutron Particles**  
Stopped by water or  
materials containing  
water (e.g., concrete)







## Inverse Square Law

The inverse square law applies to all forms of radiation (from radio waves, through the light spectrum to gamma rays).

When we move away from a light, it appears dimmer. When we move closer, it appears brighter. Similarly, when we move away from a radiation source, its effects are weaker and when we move closer, its effects are greater. The inverse square law defines how much dimmer/weaker or brighter/stronger the electromagnetic radiation is.

It simply states that, as you move farther from the source, the effect of the source is reduced by the inverse of the distance moved, squared.

### Key Point

Distance reduces radiation exposure. By doubling the distance from the source, the original radiation is decreased to 25%.

What is being measured	International System	Old System	Conversion Factors
Activity	Becquerel (Bq)	Curie (Ci)	1 Ci = 37 GBq
Radiation absorbed	Gray (Gy)	Rad (rad)	1 rad = 10 mGy
Biological effect of radiation absorbed	Sievert (Sv)	Rem (rem)	1 rem = 10 mSv

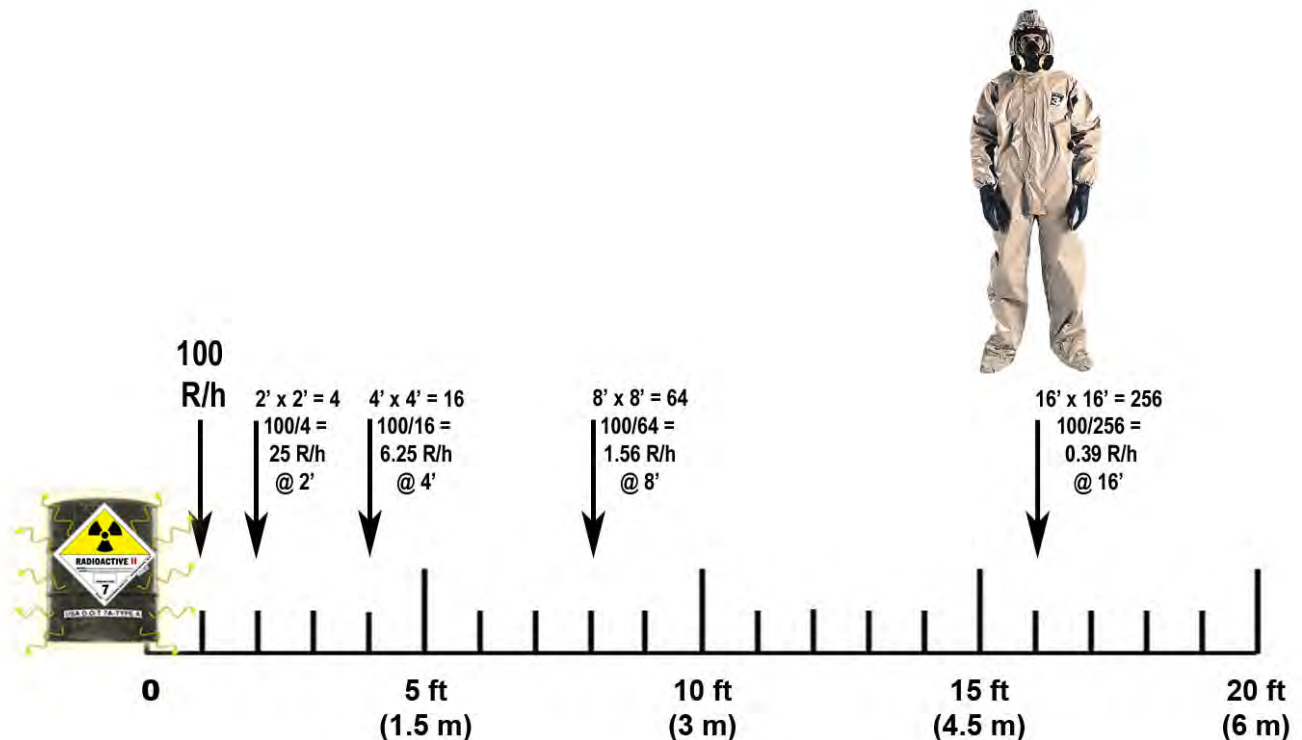



Page left blank intentionally.



## Chemical and Physical Properties

Why are factors such as vapor pressure and specific gravity important?



Property	Carbon Monoxide	Acetone	Acetylene
Vapor Pressure	>35 atm	180 mmHg	44.2 atm
Molecular Weight	26	58.1	26
Lower Explosive Limits	12.5%	2.5%	2.5%
Upper Explosive Limits	74%	12.8%	100%
Flash Point	n/a	-4°F	n/a
Solubility	2%	Miscible	2%
IDLH	1200 ppm	2500 ppm	n.d.
Specific Gravity	...	.79	...

Property	Kerosene	Propane	Gasoline
Vapor Pressure	55 mmHg	8.4 atm	38–300 mmHg
Molecular Weight	170	44.1	72
Lower Explosive Limits	0.7%	2.1%	1.4%
Upper Explosive Limits	5%	9.5%	7.6%
Flash Point	100 – 162°F	n/a	-45°F
Solubility	Insoluble	.01%	Insoluble
IDLH	n.d.	2100 ppm	Ca.
Specific Gravity	.81	...	.72

Property	Ammonia	Sulfuric Acid	Sodium Hydroxide
Vapor Pressure	8.5 atm	.001 mmHg	0 mmHg
Molecular Weight	17	96.1	40
Lower Explosive Limits	15%	n/a	n/a
Upper Explosive Limits	28%	n/a	n/a
Flash Point	n/a	n/a	n/a
Solubility	34%	Miscible	111%
IDLH	300 ppm	15 mg/m <sup>3</sup>	10 mg/m <sup>3</sup>
Specific Gravity	...	1.84	2.13



## Toxic Products of Combustion

Hazardous materials might not be as complex and difficult to manage if they were always readily visible or stored in permanent locations. But often they are just not obvious to our senses.

- They could be buried underground and potentially contaminate the water supply.
- They may lie undetected as particles of soot on turnout gear which could result in carbon exposure.
- They might be invisible/odorless, such as carbon monoxide in a small, enclosed area.

The vigilant first responder needs to consider where chemicals are readily apparent and, in addition, predict where they might not be readily apparent. They also need to be aware that some products normally considered non-hazardous can become very hazardous if they combust. Combustion can cause certain benign materials to produce toxic products that can be extremely harmful to human beings and the environment.

**All products of combustion should be considered toxic.** Therefore, first responders need to wear appropriate respiratory protection and take measures to protect people downwind from a hazardous materials fire.

Emergency responders must remain aware that products of combustion are dangerous in all fires. **Most by-products of combustion can be fatal in high concentrations.** In most cases of combustion, the air should be monitored with special devices before personal protective equipment, especially respiratory protection, is removed.

### Research Findings<sup>1</sup>

The gaseous products formed during combustion can be classified into three categories on the basis of their toxicity.

#### Asphyxiants

The first category relates to fire smoke components which have asphyxiant properties, as well as oxygen depletion due to the fire itself. These asphyxiant gases can give rise to narcosis due to central nervous system depression. Exposure to these by-products at sufficient concentration or duration of exposure can lead to unconsciousness and eventually death, due to hypoxia. The principle asphyxiants produced during combustion of organic materials are carbon monoxide, hydrogen cyanide and carbon dioxide, together with low oxygen concentration which has similar effects as the asphyxiant gases. These asphyxiants can interact, producing additive effects resulting in higher toxicity.

<sup>1</sup> A Toxicological Review of Products of Combustion, Health Protection Agency, Centre for Radiation, Chemical and Environmental Hazards, Chemical Hazards and Poison Division, 2010, retrieved from [http://www.hpa.org.uk/webc/HPAwebFile/HPAweb\\_C/1267025520632](http://www.hpa.org.uk/webc/HPAwebFile/HPAweb_C/1267025520632) (June 12, 2013).



By-Products	Source of Combustion	Toxic effects
Hydrogen cyanide	Wool, silk, nylon, polyacrylonitrile, polyurethane, paper	Interferes with respiration at the cellular level
Nitrogen dioxide and other oxides	Fabrics (produced in small quantities), cellulose nitrate and celluloid (fabrics produced in larger quantities)	Irritant capable of causing immediate death or delayed lung injury
Phosgene and hydrogen chloride	Polyvinyl chloride (PVC) and some materials treated with fire-retardants	Respiratory irritant; can be absorbed onto solid particulates which are then inhaled
Other halogen gases	Fluorinated resins or films and some fire-retardant materials containing bromine	Respiratory irritants
Isocyanates	Polyurethanes and paints, foam cushions	Respiratory irritants; may cause asthma-like reactions
Acrolein	Polyolefins, cellulose and wood-containing materials capable of heating to temperatures around 399°C (750°F)	Strong respiratory irritant; carcinogenic
Carbon monoxide	Anything containing carbon. Excess concentration remains after virtually every fire	Affects the blood's ability to exchange oxygen



**Case Study**

First responders should keep their masks on during overhaul, as toxic vapors may still be emitted from combustibles after the fire is out.

### Irritants

The second category includes smoke components which cause irritation, either as sensory irritants affecting the eyes and upper respiratory tract (nose, mouth, throat), or as pulmonary irritants (affecting the lungs), or both. The combustion of most commonly used materials, ranging from natural sources such as wood, to synthetic plastics and polymers, will result in the generation of irritant gases. Therefore, irritant gases are present in most fire atmospheres, irrespective of whether the combustion is smoldering, flaming or ventilation-controlled. The irritant gases produced can be divided into two classes: inorganic irritant gases or organic irritants. The most common inorganic irritants include halogen acids, ammonia, chlorine and phosgene. Irritant organics include wood, fossil fuels, synthetic and natural polymers and food,

### Other Toxins

A third category may be used to describe products which may give rise to toxicity, unlike the first two categories. In many cases, the combustion of organic materials, particularly if it is incomplete, may also give rise to more complex compounds, including aromatic hydrocarbons, isocyanates and particulate matter.



Use the NIOSH Pocket Guide to answer the following questions.



1. With what does hydrochloric acid react violently?

---

2. What is the molecular weight of hexane?

---

3. What is the IDLH for chlorine?

---

4. What are the LEL and UEL for ethylene oxide?

---





## Lesson 2.5 - Health and Safety Threats

### Lesson Objectives<sup>1</sup>



#### NFPA® 472, 4.4.1(3)(c)

Identify the ways hazardous materials/WMD are harmful to people, the environment and property.

#### NFPA® 472, 4.4.1 (3)(d)

Identify the general routes of entry for human exposure to hazardous materials/WMD.

#### NFPA® 472, 5.2.3 (1)(b)

Identify the differences between the following terms:

- i. Contamination and secondary contamination
- ii. Exposure and contamination
- iii. Exposure and hazard
- iv. Infectious and contagious
- v. Acute effects and chronic effects
- vi. Acute exposures and chronic exposures

#### NFPA® 472, 5.2.3(8)

Identify the health hazards associated with the following terms:

- (b) Asphyxiant
- (c) Carcinogen
- (d) Convulsant
- (e) Corrosive
- (f) Highly toxic
- (g) Irritant
- (h) Sensitizer, allergen
- (i) Target organ effects
- (j) Toxic

#### NFPA® 472, 5.3.4\*

- (1) Identify ways that people, personal protective equipment, apparatus, tools and equipment become contaminated.
- (2) Describe how the potential for secondary contamination determines the need for decontamination.
- (3) Explain the importance and limitations of decontamination procedures at hazmat incidents.



<sup>1</sup> NFPA 472® Standard for Competence of Responders to Hazardous Materials/Weapons of Mass Destruction, 2013 Edition.



## Exposure and Effects

### Common Sense Prevails

When verifying presence of hazards, use as many clues as possible, including your senses:

- ▶ Use aided, protected vision.
- ▶ Listen for clues at the scene.
- ▶ Do not use senses of taste, smell or touch (e.g., some materials have toxicity levels below one's ability to smell them).

### Exposure

**Exposure** is the process by which people, animals, the environment and equipment are subjected to, or come in contact with, a hazardous material (a contaminant). Exposure can enable a toxic chemical, infectious material or radioactive agent to enter the body.

Toxins are able to enter the body through:

- Inhalation
- Absorption: skin and eyes
- Ingestion
- Injection or puncture

**Acute Exposure** occurs when there is a:

- High concentration of chemical
- Short duration of exposure

**Chronic Exposure** occurs when there is a:

- Low (or high) concentration of chemical
- Long duration of exposure or repeated short durations of exposure

Exposure may lead to acute or chronic effects. Acute and chronic exposures and acute and chronic effects are not the same thing. **Acute effects present symptoms immediately** (e.g., exposure to mace produces acute effects) while **chronic effects manifest at a later time** (e.g., cancer resulting from repeated exposure to diesel exhaust), which can take days, months and even years after exposure to produce effects.

### Factors Affecting Toxic Exposure

Some materials pose little threat if the exposure time is short (acute) even if the concentration of material is relatively high. However, significant (chronic) exposure can result from prolonged exposure to a chemical. Repeated exposure to such common hazardous materials as gasoline is correlated with liver as well as respiratory diseases. Chronic health problems also result from repeated exposure to diesel exhaust fumes (sulfur dioxide, a by-product, is a known carcinogen), therefore fire stations need to be equipped with vehicle exhaust systems.

### Contamination

**Contamination** is the presence of a hazmat that physically remains on or in people, animals, the environment or equipment—thereby creating a continuing risk of direct injury or a risk of exposure. Sometimes contaminants can be removed from skin, hair, clothing, accessories and vehicles—thereby eliminating or minimizing negative health effects. Once toxins enter the body, total reversal or removal may not be possible; therefore, the goal is avoidance.



## Toxic Exposure Routes

### Inhalation

Inhalation is the easiest and fastest route of exposure. First responders remain at high risk unless they wear their self contained breathing apparatus (SCBA) until a determination has been made regarding the presence of chemical products or by-products at an incident scene.



The lungs act as a transfer point in the human body. Chemicals and infectious agents can enter the body through inhalation, without notice. The main reason solids are generally considered less toxic than gases is because they are less likely to be inhaled. By contrast, even a small amount of a gas such as chlorine can have very toxic effects if inhaled. The rate and depth of respiration affect the amount of material absorbed. Faster, deeper respiration increases exposure.

### Absorption Through the Eyes

Up to 90% of hazardous materials can be absorbed through the eyes. The eyes can be negatively affected by exposure. Damaging and severe injuries to the eyes can result from basic (alkali) splashes. Only 10% of all eye injuries involve hazardous chemicals—the most severe ones result from chemical burns. Chemicals that are both water and fat-soluble penetrate the farthest, doing the most damage. Common chemicals that could cause severe or irreversible injury to the eye are sodium hydroxide/caustic soda/lye, quick lime, ammonia, sulfuric acid and hydrocarbons.



### Absorption Through the Skin

Toxic substances can be absorbed through the skin, or enter the bloodstream through broken skin.

Absorption is influenced by several factors:

- The **longer** a material is in contact with the skin, the greater the amount absorbed.
- The **greater** the concentration of the chemical, the greater the amount absorbed.
- **Elevated** skin temperature and greater blood flow increase the rate of absorption.
- Areas with **hair follicles** allow for greater absorption. For example, the groin is 300 times more susceptible to absorption than the foot.
- The **type of chemical** affects exposure. For example, fat-soluble chemicals, like solvents (e.g., carbon disulfide, dimethyl sulfoxide, benzene) are most readily absorbed through the skin, and can damage internal organs such as the liver.

The degree and severity of absorption can vary based on the integrity of the skin. Skin can be damaged, and promote greater absorption (hence exposure) if subject to trauma, heat/cold, humidity and moisture and/or previous chemical exposures.



## Ingestion

Toxic materials can be swallowed if they come in contact with the mouth. Ingested materials can affect other organs as well as the gastrointestinal system. To avoid exposure through ingestion, always complete decontamination before you eat or drink. (Decontamination procedures, for removing contaminants before they have a chance to enter the body, are discussed later in this course.)



## Injection and Puncturing

Injections and punctures result from contact with sharp objects such as syringes, high pressure devices or sharp objects (e.g., jagged pieces of glass or metal). Injections pierce the skin, providing an opening for other chemicals to enter.



Injuries from injection and puncture can be more serious than surface contact because chemicals can penetrate deep into the tissues, closer to vital organs and the circulatory system. Consequently, determining the extent of such an exposure may be difficult.



## Toxic Chemical Effects

Chemicals differ in the effect each has on the body. As mentioned previously, some effects are acute and others are chronic, depending on the length of exposure and concentration of the specific chemical. A single chemical may produce a range of effects over time. The effects of chemicals are not always well-researched, so first responders should document all exposures and any changes in normal body functions. The NIOSH Pocket Guide offers information about toxic effects of select hazardous substances.

The following chart lists types of toxic chemicals. The chart also provides a description of each type, along with examples of those types of hazardous materials.

Types	Description	Examples
Asphyxiants	<ul style="list-style-type: none"> <li>• Gases that deprive the body tissue of oxygen</li> <li>• There are two types:                             <ul style="list-style-type: none"> <li>▫ Simple asphyxiants displace oxygen</li> <li>▫ Chemical asphyxiants are gases that prevent oxygen use by the body's tissues, even though enough oxygen is inhaled</li> </ul> </li> <li>• Signs of exposure include restlessness, agitation, drowsiness, confusion, stupor and coma</li> </ul>	<p>Simple asphyxiants:</p> <ul style="list-style-type: none"> <li>• Carbon dioxide</li> <li>• Methane</li> <li>• Nitrogen</li> <li>• Propane</li> <li>• Argon</li> </ul> <p>Chemical asphyxiants:</p> <ul style="list-style-type: none"> <li>• Carbon monoxide</li> <li>• Hydrogen cyanide</li> <li>• Hydrogen sulfide</li> <li>• Sulfur dioxide</li> </ul>
Biological Hazards	Most likely to occur at EMS calls involving bloodborne pathogens or airborne pathogens	<ul style="list-style-type: none"> <li>• Any container that carries a biohazard symbol potentially carries an infectious material</li> <li>• Keep in mind that laboratory specimens (e.g. animals, petri dishes) may be infectious</li> <li>• Hepatitis A, B and C</li> <li>• HIV</li> <li>• Herpes virus</li> <li>• Tuberculosis (TB)</li> </ul>



Types	Description	Examples
Carcinogens	<ul style="list-style-type: none"> <li>• Can cause cancer</li> <li>• Cancers may take up to 20 years to develop, following exposure</li> <li>• Levels of exposure may be difficult to document; little is known about possible effects from exposure to multiple carcinogens</li> </ul>	<ul style="list-style-type: none"> <li>• Benzene (in gasoline; associated with leukemia)</li> <li>• Vinyl chloride (associated with liver cancer)</li> <li>• Asbestos (associated with lung cancer)</li> <li>• Radioactives</li> <li>• Gasoline</li> <li>• Formaldehyde</li> </ul>
Convulsants	<ul style="list-style-type: none"> <li>• Psychotropic materials which cause changes to the central nervous system</li> <li>• Designed as incapacitating agents</li> <li>• Tend to be non-toxic and non-persistent</li> <li>• Use dates back to at least 200 BC</li> </ul>	<ul style="list-style-type: none"> <li>• Belladonna</li> <li>• Night shade</li> <li>• BZ</li> <li>• Mandrake root</li> <li>• Jimson (loco) weed</li> <li>• Atropine</li> <li>• Scopolamine</li> </ul>
Corrosives	<ul style="list-style-type: none"> <li>• Can cause irreversible tissue damage               <ul style="list-style-type: none"> <li>▫ Acids</li> <li>▫ Alkalis (bases or caustics)</li> </ul> </li> <li>• Effects depend on concentration of chemical and strength of the acid or base</li> <li>• Mild tissue damage from a corrosive may resemble a burn from heat</li> <li>• Eyes, skin, mucous membranes highly susceptible to effects</li> <li>• Causes irritation, pain and burning</li> <li>• If inhaled, causes coughing, difficulty breathing</li> </ul>	<ul style="list-style-type: none"> <li>• Caustic soda</li> <li>• Sulfuric acid</li> <li>• Hydrochloric acid</li> <li>• Nitric acid</li> <li>• Calcium carbonate</li> <li>• Potassium hydroxide</li> <li>• Uranium hexafluoride</li> <li>• Alkylating agents such as potassium permanganate</li> </ul>
Highly toxic	<p>A chemical that falls within any of the following categories:</p> <ul style="list-style-type: none"> <li>• A chemical that has a median lethal dose (LD50) of 50 mg or less per kilogram of body weight when administered orally to albino rats weighing between 200 g and 300 g each</li> <li>• A chemical that has a median lethal dose (LD50) of 200 mg or less per kilogram of body weight when administered by continuous contact for 24 hours (or less if death occurs within 24 hours) with the bare skin of albino rabbits weighing between 2 kg and 3 kg each</li> <li>• A chemical that has a median lethal concentration (LD50) in air of 200 parts per million by volume or less of gas or vapor, or 2 mg per liter or less of mist, fume or dust, when administered by continuous inhalation for 1 hour (or less if death occurs within 1 hour) to albino rats weighing between 200 g and 300 g each [NFPA® 472, A.5.2.3(8)(3)]</li> </ul>	(Ask instructors to provide this information.)
Irritants	Can cause temporary, severe inflammation of the eyes, skin or respiratory tract	<ul style="list-style-type: none"> <li>• Sulfur dioxide</li> <li>• Sulfur dioxide</li> <li>• Pepper spray</li> <li>• Tear gas</li> </ul>
Sensitizers, Allergen	<ul style="list-style-type: none"> <li>• Can cause allergic reactions after repeated exposures</li> <li>• Reactions may be different because some people are more susceptible to the effects of sensitizers</li> <li>• Repeated exposure may cause a rash on skin, or an asthma-like reaction if the sensitizer is inhaled</li> </ul>	<ul style="list-style-type: none"> <li>• Gasoline</li> <li>• Pesticides</li> <li>• Nickel</li> </ul>





Types	Description	Examples
Target organ effects	<p>A target organ categorization of effects that can occur, including examples of signs and symptoms and chemicals that have been found to cause such effects. The following examples illustrate the range and diversity of effects and hazards that can be encountered and are not intended to be all-inclusive:</p> <ul style="list-style-type: none"> <li>• <b>Hepatotoxins.</b> Chemicals that produce liver damage (signs and symptoms: jaundice, liver enlargement)</li> <li>• <b>Nephrotoxins.</b> Chemicals that produce kidney damage (signs and symptoms: edema, protein urea)</li> <li>• <b>Neurotoxins.</b> Chemicals that produce their primary toxic effects on the nervous system: <ul style="list-style-type: none"> <li>▫ <b>Central nervous system hazards.</b> Chemicals that cause depression or stimulation of consciousness or otherwise injure the brain (signs and symptoms: drooping of upper eyelids, respiratory difficulty, seizures, unconsciousness)</li> <li>▫ <b>Peripheral nervous system hazards.</b> Chemicals that damage the nerves that transmit messages to and from the brain and the rest of the body (signs and symptoms: numbness, tingling, decreased sensation, change in reflexes, decreased motor strength)</li> </ul> </li> <li>• <b>Agents that decrease hemoglobin in the blood</b> and deprive the hematopoietic body tissues of oxygen (signs and symptoms: cyanosis, loss of consciousness)</li> <li>• <b>Agents that irritate the lung or damage the pulmonary tissue</b> (signs and symptoms: cough, tightness in chest, shortness of breath)</li> <li>• <b>Reproductive toxins.</b> Chemicals that affect the reproductive capabilities, including chromosomal damage (mutations) and effects on fetuses (teratogenesis) (signs and symptoms: birth defects, sterility)</li> <li>• <b>Cutaneous hazards.</b> Chemicals that affect the dermal layer of the body (signs and symptoms: defatting of the skin, rashes, irritation)</li> <li>• <b>Eye hazards.</b> Chemicals that affect the eye or visual capacity (signs and symptoms: conjunctivitis, corneal damage) [NFPA® 472, A.5.2.3(8)(7)]</li> </ul>	<ul style="list-style-type: none"> <li>• Hepatotoxins <ul style="list-style-type: none"> <li>▫ Carbon tetrachloride</li> <li>▫ Nitrosamines</li> </ul> </li> <li>• Nephrotoxins <ul style="list-style-type: none"> <li>▫ Halogenated hydrocarbons</li> <li>▫ Uranium</li> </ul> </li> <li>• Peripheral nervous system hazards <ul style="list-style-type: none"> <li>▫ Arsenic</li> <li>▫ Lead</li> <li>▫ Toluene</li> <li>▫ Styrene</li> </ul> </li> <li>• Agents that decrease hemoglobin <ul style="list-style-type: none"> <li>▫ Carbon monoxide</li> <li>▫ Benzene</li> </ul> </li> <li>• Agents that irritate the lungs <ul style="list-style-type: none"> <li>▫ Silica</li> <li>▫ Asbestos</li> <li>▫ Hydrochloric acid (HCl)</li> </ul> </li> <li>• Reproductive toxins <ul style="list-style-type: none"> <li>▫ Lead</li> <li>▫ DBCP</li> </ul> </li> <li>• Cutaneous hazards <ul style="list-style-type: none"> <li>▫ Ketones</li> <li>▫ Chlorinated compounds</li> </ul> </li> <li>• Eye hazards <ul style="list-style-type: none"> <li>▫ Organic solvents</li> <li>▫ Acids</li> </ul> </li> </ul>
Toxic	<p>A chemical that falls within any of the following categories:</p> <ul style="list-style-type: none"> <li>• (a) A chemical that has a median lethal dose (LD50) of more than 50 mg per kilogram but not more than 500 mg per kilogram of body weight when administered orally to albino rats weighing between 200 g and 300 g each</li> <li>• (b) A chemical that has a median lethal dose (LD50) of more than 200 mg per kilogram but not more than 1,000 mg per kilogram of body weight when administered by continuous contact for 24 hours (or less if death occurs within 24 hours) with the bare skin of albino rabbits weighing between 2 kg and 3 kg each [NFPA® 472, A.5.2.3(8)(6)]</li> </ul>	(Ask instructors to provide this information.)



## Contamination

First responders come in contact with toxic contaminants routinely in the line of duty. For example, soot containing carbon residue may cling to clothing, skin, hair or equipment. The goal is to avoid exposure by keeping contaminants away from routes of entry into the body (inhalation, absorption, etc.). Because many toxins are invisible, this goal is difficult to achieve, making the use of appropriate protective fire fighting clothing extremely important.

**Contamination may, or may not, lead to exposure.** If the contaminant has not penetrated one's clothing (and nothing toxic has already been inhaled), it might be possible to quickly remove the toxin (e.g., brush or wash it off, disinfect it) and thereby avoid, discontinue or minimize exposure. However, if a toxic substance comes in direct contact with one's skin or hair (perhaps through saturated clothing), exposure may very well occur, and will continue indefinitely unless, and until, thoroughly removed. All personnel, clothing and equipment that are potentially contaminated can be decontaminated by:

- Physically removing contaminants
- Disinfecting biological contaminants

Debris and dirt that settle on clothing and equipment during fire fighting may produce known and unknown toxins. **PPE should be decontaminated after every use before removing protective clothing and respiratory protection.** Gear is often scrubbed with a mixture of detergent and water to sufficiently remove surface contaminants while the clothing is still being worn. Then, a more thorough decontamination occurs after removal of clothing. Unless decontamination measures are taken, contaminants such as asbestos fibers can easily spread to the riding areas of apparatus and to the living areas of fire stations. Local fire departments should have their own standard operating procedures for handling contaminated turnouts when regular laundering is not sufficient/appropriate.

**Secondary Contamination** is contamination from a secondary source. Emergency responders who work with contaminated patients are subject to exposure through all of the known routes of bodily entry. Therefore, to avoid the spread of contamination between and among patients and responders, patients with potential contamination need to be decontaminated before administration of any emergency care or transport. Emergency responders may also become contaminated through contact with equipment that is contaminated or has been improperly or incompletely decontaminated. Equipment needs to be thoroughly decontaminated before reuse (or disposed of) to protect responders from exposure.



## NFPA® Definitions Related to Contamination

The following terms related to contamination have been defined in NFPA® 472: Standard for Competence of Responders to Hazardous Materials/ Weapons of Mass Destruction, 2013 Edition.

Term	NFPA® Definition
Contamination <i>Product is on you.</i>	The process of transferring a dangerous good, or the hazardous component of a CBRNE agent, from its source to people, animals, the environment or equipment, that can act as a carrier.
Cross Contamination	The process by which a contaminant is carried out of the hot zone and contaminates people, animals, the environment or equipment.
Exposure <i>Product is in you.</i>	The process by which people, animals, the environment and equipment are subjected to, or come in contact with, a dangerous good/CBRNE agent.
Hazard/Hazardous	A product or agent capable of posing an unreasonable risk to health, safety or the environment; capable of causing harm.



According to the standard, operations level responders should be able to identify the differences between the following terms:

- Contamination and secondary contamination
- Exposure and contamination
- Exposure and hazards

### Contamination Versus Secondary Contamination

Contamination is the direct transfer of a hazardous product, whereas secondary contamination is the indirect transfer that may be the result of cross contamination. For example, a member of an entry team at an incident involving hazardous materials may carry contaminants out of the hot zone on his or her protective clothing, skin, hair and equipment. If he or she is not adequately decontaminated, other personnel and/or equipment may become contaminated—this indirect transfer results in secondary contamination.



Page left blank intentionally.



## Lesson 2.6 - WMD Incidents

### Lesson Objectives<sup>1</sup>

#### NFPA® 472, 4.2.1

- (1) Identify the definitions of hazardous material and WMD.
- (4) Identify the difference between hazmat/WMD incidents and other emergencies.
- (13) Identify at least four types of locations that could be targets for criminal or terrorist activity using hazmat/WMD.
- (14) Describe the difference between a chemical and a biological incident.
- (15) Identify at least four indicators of possible criminal or terrorist activity involving chemical agents.
- (16) Identify at least four indicators of possible criminal or terrorist activity involving biological agents.
- (17) Identify at least four indicators of possible criminal or terrorist activity involving radiological agents.
- (18) Identify at least four indicators of possible criminal or terrorist activity involving illicit laboratories (clandestine laboratories, weapons lab, ricin lab).
- (19) Identify at least four indicators of possible criminal or terrorist activity involving explosives.
- (20) Identify at least four indicators of secondary devices.

#### NFPA® 472, 4.4.1(12)

Identify at least four specific actions necessary when an incident is suspected to involve criminal or terrorist activity.

#### NFPA® 472, 5.2.1.6

Identify at least three additional hazards that could be associated with an incident involving terrorist or criminal activities.

#### NFPA® 472, 5.2.2 (6)

Identify the type of assistance provided by governmental authorities with respect to criminal or terrorist activities involving the release, or potential releases of hazmat/WMD.



### Government Agency Leaders

The law enforcement, or crisis management, response to terrorism is conducted by the FBI. It provides training on topics such as evidence collection and preservation, intelligence gathering related to the prevention of terrorist activities, and pursuit of offenders.

Consequence management relates to the emergency response of an actual event. The Federal Emergency Management Agency (FEMA) is the lead federal agency for this separate function. It provides training in responding to terrorism, working with communities to build reinforced infrastructure, and coordinating federal response in the likelihood of terrorist events.



<sup>1</sup> NFPA 472® Standard for Competence of Responders to Hazardous Materials/Weapons of Mass Destruction, 2013 Edition.



**NFPA® 472, 5.2.3(1)(b)(iv)**

Identify the differences between infectious and contagious.

**NFPA® 472, 5.2.3 (9)**

Given the following, identify the corresponding UN/DOT hazard class and division:

- (a) Blood agents
- (b) Biological agents and biological toxins
- (c) Choking agents
- (d) Irritants (riot control agents)
- (e) Nerve agents
- (f) Radiological materials
- (g) Vesicants (blister agents)

**NFPA® 472, 5.3.1(4)**

Describe the potential for secondary attacks and devices at criminal or terrorist events.

**NFPA® 472, 5.4.2**

Describe the process to preserve evidence.





## Definition of Terrorism

### Code of Federal Regulations (CFR) Definition

There is no single, universally accepted definition of terrorism.<sup>1</sup> Terrorism is defined in the United States Code of Federal Regulations (CFR) as:

“...the unlawful use of force and violence against persons or property to intimidate or coerce a government, the civilian population, or any segment thereof, in furtherance of political or social objectives.”<sup>2</sup>

Regardless of the entity, the key concepts for most definitions of terrorism are:

- It is a criminal, usually violent, act.
- The intent is to intimidate or coerce.
- The individuals involved have a political and/or social agenda.

### Federal Bureau of Investigation (FBI) Definition

The FBI describes terrorism as either domestic or international, depending on the origin, base and objectives of the terrorist organization.

- **Domestic terrorism** refers to activities that involve acts dangerous to human life that are a violation of the criminal laws of the United States or of any state; appear to be intended to intimidate or coerce a civilian population; to influence the policy of a government by mass destruction, assassination or kidnapping; and occur primarily within the territorial jurisdiction of the United States.
- **International terrorism** involves violent acts or acts dangerous to human life that are a violation of the criminal laws of the United States or any state, or that would be a criminal violation if committed within the jurisdiction of the United States or any state. These acts appear to be intended to intimidate or coerce a civilian population; influence the policy of a government by intimidation or coercion; or affect the conduct of a government by mass destruction, assassination or kidnapping; and occur primarily outside the territorial jurisdiction of the United States or transcend national boundaries in terms of the means by which they are accomplished, the persons they appear intended to intimidate or coerce, or the locale in which their perpetrators operate or seek asylum.<sup>3</sup>

The FBI defines a **terrorist incident** as a violent act or an act dangerous to human life, in violation of the criminal laws of the United States, or of any state, to intimidate or coerce a government, the civilian population, or any segment thereof, in furtherance of political or social objectives.

<sup>1</sup> [http://www.fbi.gov/publications/terror/terror2000\\_2001.htm](http://www.fbi.gov/publications/terror/terror2000_2001.htm).

<sup>2</sup> 28 Code of Federal Regulations (CFR) § 0.85.

<sup>3</sup> 18 USC § 2331(1)



## Definition of Weapon of Mass Destruction

The NFPA® bases its definition of a weapon of mass destruction (WMD) on 18 United States Code 2332a:

1. Any destructive device, such as any explosive, incendiary or poison gas bomb, grenade or rocket having a propellant charge of more than four ounces, missile having an explosive or incendiary charge of more than one quarter ounce (7 grams), mine or device similar to the above
2. Any weapon involving toxic or poisonous chemicals
3. Any weapon involving a disease organism
4. Any weapon that is designed to release radiation or radioactivity at a level dangerous to human life<sup>1</sup>

### Improvised Explosive Device



### Anthrax



### Pipe Bomb

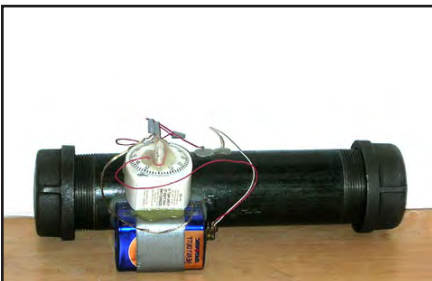

There are many acronyms used (and being used) by other agencies or groups to describe terrorist weapons. WMDs may be referred to as:

- BNICE – biological, nuclear, incendiary, chemical, explosive
- CBRN – chemical, biological, radioactive, nuclear (used in Canada prior to 2009)
- CBRNE – chemical, biological, radioactive, nuclear, explosive (currently used in Canada)
- NBC – nuclear, biological, chemical

Although many acronyms are used, the concept, materials and agents are basically the same.

<sup>1</sup> NFPA® 472, 3.3.62



## Potential Targets of Criminal or Terrorist Activity

Threats to the United States do not come from any one individual or group. They may originate in distant lands or local neighborhoods. They may be as simple as a home-made bomb or as sophisticated as a biological threat or coordinated cyber attack. More and more, state, local, and tribal law enforcement officers, as well as citizens, businesses and communities are on the front lines of detection and prevention.<sup>1</sup>

The following types of locations could be targets and/or sources of WMDs for criminal or terrorist activity using hazmats/WMDs.

- Public assembly
- Public buildings
- Mass transit systems
- Places with high economic impact
- Telecommunications facilities
- Historic/symbolic places
- Military installations
- Airports
- Industrial facilities

## Potential Hazards at WMD Incidents

The following are additional hazards that could be associated with an incident involving terrorist or criminal activities.

- The potential target (e.g., a rail car containing toxic chemicals)
- Secondary events and/or threats to incapacitate or delay emergency responders
- Secondary contamination from handling patients
- Armed resistance
- Use of weapons
- Booby traps

Additional considerations at a WMD incident include the need to request law enforcement and perform evidence preservation.

<sup>1</sup> <http://www.dhs.gov/preventing-terrorism-and-enhancing-security>

First responders' primary responsibility may be to isolate the hazard and prevent further injuries and/or damage. In addition, first responders should remember that terrorist acts are crimes, and there may be evidence at the scene that needs to be preserved.



## Hazardous Materials/WMD Incidents Compared to Other Emergencies

Both hazardous materials and WMD incidents involve substances (either matter—solid, liquid or gas—or energy) that, when released, are capable of creating harm to people, the environment and property. Incidents occur when those substances have the potential to be, or have been, released.<sup>1</sup>

The main difference between a hazardous materials incident and a WMD incident is the presence of criminal intent. Since, as a first responder, you will rarely know the intent behind a release, the use of safe response practices such as APIE is your best form of protection. Additionally, you may need to be familiar with local procedures for evidence preservation to ensure your actions do not disturb or destroy valuable evidence.

Although first responder actions at WMD incidents will parallel those at hazmat incidents, there are differences. At WMD incidents **there is always the possibility that secondary or multiple threats may be present.** Often these threats are designed specifically to deter emergency response by injuring or killing first responders. Secondary threats are just what their name implies—they are devices designed to initiate after another device has been activated and, often, after emergency responders have arrived in response to the initial incident. Although secondary threats could include active shooters or devices made using chemical, radiological or biological agents, explosive devices are most commonly used.

Both hazardous materials and WMD incidents may result in mass casualties. First responders will be challenged by the need to rescue, decontaminate, triage, treat and transport many people. Rescues may be difficult depending on the amount of structural damage the hazardous materials/WMDs have caused and the number of victims. Mass decontamination may require additional personnel and equipment. Medical transports and hospitals may quickly become overburdened.

The immediate response to a terrorist incident will often involve strong coordination of effort between federal departments and agencies and could also include provincial, territorial and municipal authorities, as well as private businesses, critical infrastructure owners and operators and the general public, depending on where the incident occurs and the extent of the impacts.<sup>2</sup>

1 National Fire Protection Association® 472, Standard for Competence of Responders to Hazardous Materials/Weapons of Mass Destruction Incidents, 2013 Edition, 3.3.29 Hazardous Material.

2 Building Resilience Against Terrorism: Canada's Counter-terrorism Strategy. <http://www.publicsafety.gc.ca/prg/ns/2012-cts-eng.aspx> (retrieved June 21, 2013).



## Secondary Threats

Secondary threats are often placed in likely command and staging areas, evidence that terrorists may specifically target emergency responders. Many believe that terrorists who want to target first responders create a series of false alarms to the same location in order to study and determine response routes and staging areas. This technique, called a “probe,” can be an effective means of identifying responder vulnerabilities. Secondary or multiple threats may be hidden in ordinary-looking containers (e.g., planters, mailboxes, trash cans).

In addition, at WMD incidents there is the possibility that the person or persons responsible are still present, resulting in an additional hazard to first responders. Often, terrorists use the initial attack as a means to draw out victims and draw in first responders. First responders should survey the scene carefully, and remain on the lookout for secondary or multiple devices and persons who are not emergency responders.

As part of an initial scene survey, first responders should be on the look out for secondary devices as follows:

1. Look for likely areas where secondary devices might be placed.
2. Visually scan the area for secondary devices.
3. Avoid touching or moving anything that might conceal an explosive device.
4. Designate and enforce scene control.
5. Evacuate victims, other responders and nonessential personnel as quickly and as safely as possible.

Indicators of possible secondary devices may include reports of unattended packages, packages with wires or timing devices, warnings or threats of attack/received intelligence, unusual or suspicious persons/vehicles.



## Evidence Preservation

WMD incidents, by definition, are crime scenes. Physical evidence, that is recognized and preserved, provides objective and reliable information about an incident. It may even play a major role in the apprehension of suspects as well as the judicial process.

*Use the space below for your notes.*

**List items of evidence that could be gathered at the suspected terrorist incident.**

---

---

---

Physical evidence can be microscopic (e.g., chemical residue) to massive (e.g., the fuselage of an aircraft). Physical evidence may include:

- Discarded personal protection equipment
- Specialized packaging (e.g., shipping papers, labels and placards)
- Glass or metal fragments
- Containers (e.g., biohazard, plastic, pipes, cylinders, bottles, fuel)
- Roadway flares
- Electrical components
- Chemicals

**The most important factor to consider, as it relates to evidence preservation, is the chain-of-custody.** Chain-of-custody refers to the chronological and careful documentation of evidence to establish its connection to an alleged crime scene. If the chain-of-custody is broken, the evidence may be inadmissible in court.

Evidence preservation refers to those actions or inactions taken by first responders to secure and protect evidence. It is vital for first responders to know the procedures for evidence preservation BEFORE an incident occurs. The procedures for evidence preservation should be included in the local emergency response plan or SOPs/SOGs.





Generally, first responders will only be responsible for establishing a means of evidence preservation by isolating the scene and any identifiable evidence. Sampling and collection of evidence is usually performed by specially trained law enforcement personnel. In some jurisdictions, first responders may receive mission-specific training which allows them to assist with evidence collection under the supervision of law enforcement or hazmat technicians.

As with all emergency response operations, life safety is the first priority. Potential hazards to first responders include not only chemical and/or biological materials, but also booby traps, fire arms, unsafe structures, insecure environment (e.g., suspect may still be present) and other risks encountered at hazardous materials incidents.

In the absence of SOPs/SOGs, the following general guidelines may be followed.

- Secure and isolate the area where the evidence is located.
- Do not touch anything within the isolated area.
- Leave fatalities and body parts in place and secure the area.
- Isolate any apparent source locations (e.g., the blast or spill area).
- Leave any explosive components or housing materials in place.
- Place light-colored tarpaulins at entrance and exit areas of zones, decontamination, treatment or rehabilitation areas.

Remember to **follow local policies, guideline and procedures** at incidents that may involve criminal use of WMDs!



## Explosives and Incendiaries

Explosives and incendiaries are the most commonly used terrorist weapons; they are used in about 70% of all terrorist acts. They are relatively easy and inexpensive to construct and transport, and their effects can be devastating.



### Explosives

Explosive devices are tools designed as weapons to destroy a target using a rapid and violent expansion of gas under increased air pressure. Examples include dynamite and ANFO (mixture of ammonium nitrate and fuel oil).

Indicators of an explosive device may include unexplained explosions, warnings or threats of attack/received intelligence, accelerant odors, multiple fires or explosions suspicious packages/belongings left in a public areas, packages with wires or timing devices/electronic devices, or vehicles weighed down and/or parked in unusual locations.

Predictable explosive reactions include shrapnel and flying debris, blast overpressure and thermal effects.

### Shrapnel and Flying Debris

Shrapnel and flying debris are the most common sources of injury from an explosion. Shrapnel includes items such as nails, metal shavings, etc., that have been intentionally added to the device to increase its damaging potential. In addition, the use of organic material may be doubly dangerous as it increases the potential for infection.

Debris includes portions of an explosive device, such as the housing, timing mechanism, etc., that break up and are dispersed by the detonation. Debris may also include structural components of buildings, vehicle parts, living tissue, etc. Flying glass is often the cause of injury.

Shrapnel and debris can fly for a distance over 300 feet for a small device (pipe or letter bomb) to over 4,000 feet for a vehicle bomb.



## Blast Overpressure



Blast overpressure is the rapid increase in air pressure caused by rapid gas expansion. Overpressure—which forces air, furnishings, people, buildings, etc., out from the explosion—is followed by negative pressure which pulls air, debris, people, etc., back in toward the explosion.

Blast overpressure, from small devices such as pipe and letter bombs, can cause fatal injuries to individuals as far away as 25 feet. Larger devices, such as vehicle bombs can be fatal to those as far away as 500 feet. Degree of harm is related to size of the bomb and proximity to the device.

## Thermal Effects

Thermal effects are caused by the rapid build-up of heat and the expansion of gases at the site of the blast. These rapid thermal effects are similar to a flashover.

## Incendiaries

The term incendiary is used to describe a type of device, or a component of a device, with the capability of starting fires (which may, or may not, be explosive). Incendiaries include gasoline, as an example.

## Indicators of an Explosive Device

Indicators of an explosive device may include unexplained explosions, warnings or threats of attack/received intelligence, accelerant odors, multiple fires or explosions suspicious packages/belongings left in a public areas, packages with wires, or timing devices/electronic devices, or vehicles weighed down and/or parked in unusual locations.



## Chemical Agents

Chemical agents are materials that rely on chemical action to cause harm. These include common industrial chemicals such as chlorine or ammonia. While the signs and symptoms of chemical exposure may differ depending on type of agent and severity of exposure, potential outcomes may include physical injury, acute and/or chronic illness and death.

### Nerve Agents

Nerve agents are among the most toxic of the chemical WMDs, with the potential to cause symptoms within seconds of exposure. They attack the nervous system, affecting nerve impulses until the system can no longer control basic body functions. A single drop of the most potent types can cause convulsions, loss of consciousness and death.

Most nerve agents, both military and commercial, are organophosphates. They are highly toxic and prevent the proper transmission of nerve impulses. Examples include sarin (GB), tabun (GA), soman (GD) and VX. Carbamates, also used as nerve agents, tend to be less toxic and present the most serious health problems for geriatric and very young victims.

In addition, there are a number of commercially available pesticides that, while generally not as potent as the military agents, have very similar effects (both acute and chronic) on body systems. These include organophosphates and carbamates. Examples of each are:

- Carbamates: Furacarb®, Furadan®, Carbofuran, Carbaryl, Sevin®
- Organophosphates: Malathion, Spectracide®, Diazinon

Exposure to nerve agents can cause pervasive health problems. In fact, many of the hospital and emergency workers who were exposed to sarin in the Tokyo subway incident of 1995, are still suffering problems with vision, hearing and balance.



## Blister Agents/Vesicants

Exposure to blister agents comes through inhalation and direct skin contact, resulting in tissue damage and the subsequent formation of large blisters. Over time, the blisters can leave large open wounds that are susceptible to infection.

Mild effects may resemble industrial corrosive burns. Examples of military blister agents include:

- Mustards
- Phosgene oxime

## Blood Agents

Blood agents (also known as chemical asphyxiants) prevent the body's cells from either receiving or using oxygen, depending on the specific agent involved. In either case, cells die rapidly from lack of oxygen, with brain tissue often affected first.

Two types of blood agents are considered likely WMDs:

- **Cyanides** prevent the body's cells from using the blood's oxygen. Of cyanide-based blood agents, two are significant WMDs: hydrogen cyanide (more lethal than other cyanides—death can occur in fifteen minutes) and cyanogen chloride (death can occur within minutes).
- **Arsine** is the most volatile blood agent and is generally dispersed as a vapor. It is an industrial chemical that can have the effect of a WMD weapon.

**Carbon monoxide** is also a chemical asphyxiant. It produces body system effects that are very similar to the blood agents. Symptoms of blood agent exposure include headache, rapid breathing, nausea, weakness, dizziness, confusion and blue skin/lips (cyanosis).

## Choking Agents

Choking agents are respiratory irritants. Many of these chemicals are routinely used in industrial processes. The most common choking agents are:

- Anhydrous ammonia
- Chlorine
- Phosgene

Symptoms of exposure to choking agents include eye irritation, difficulty breathing and/or chest pain.



A photo of a vesicant injury. Note that the patient was wearing a short sleeve shirt that offered limited protection when compared to the open skin of the lower arm.



Pepper spray is an incapacitating agent.



## Key Terms

- ▶ **Infectious** means a disease is caused by microorganisms such as bacteria, viruses or protozoa.
- ▶ **Contagious** means the disease or infection is transmitted from person-to-person.

## Biological Agents

Biological agents are living entities or their by-products. They can be distributed to the air through an aerosol sprayer, so they can adversely affect a large area very quickly.

### Pathogens

Pathogens are living organisms and therefore may be able to multiply once they are released into the environment. Pathogens can be spread through food and water, and through animals and humans. Pathogens spread through the air, blood and other body fluids. Symptoms from pathogen exposure are often delayed several days to weeks. Pathogens include disease-producing bacteria and viruses (e.g., anthrax, smallpox, hepatitis B virus, Ebola virus).

Pathogens can be contagious (i.e., they can be spread from one person to another). This is of great concern to first responders because their EMS work routinely puts them in contact with sick individuals.

**Some diseases are contagious such as influenza and Methicillin-Resistant Staphylococcus Aureus (MRSA). Other diseases are infectious but are not contagious, such as anthrax and tetanus.**

### Dissemination

Dissemination refers to the way an agent is released into the environment. To be effective, the dissemination method needs to put the agent in contact with as many people as possible. Aerosolization is usually the most effective way to disseminate biological agents. (An aerosol is a suspension of liquid droplets or small particles in the air.)

While the manner of release is an extremely important factor in the spread of biological WMDs, transmission methods are of much greater significance to first responders.





## Transmission Methods

Transmission refers to the spread of biological agents through animals (most commonly biting insects such as ticks or mosquitoes), food and water, and through human carriers.

Airborne spread of pathogens from one person to another—by breathing in contaminated droplets suspended in air (such as from a sneeze or cough)—is perhaps of greatest concern to the general public, as well as to first responders. In addition, many diseases are readily transmitted through blood and other body fluids. Contagious people are known as carriers or vectors.

A release into the environment would affect first responders and civilians equally, at least initially. However, because first responders are often involved in EMS work, and many are routinely in direct contact with patients who may have significant medical issues, they must routinely use body substance isolation (BSI) to limit the spread of pathogens/toxins.

## Toxins

Toxins are not living organisms and cannot multiply after dispersion. Therefore, they are not contagious and do not cause epidemics. Symptoms of toxic exposure usually develop within minutes to hours. Examples of toxins include aflatoxin, ricin and botulinum. Other more commonplace examples include poison ivy, poison oak and snake venom.

Pathogens (Bacteria, Viruses)	Toxins
Living organisms	Non-living
Can multiply after dispersion	Cannot multiply after dispersion
Can be contagious	Not contagious
Can cause epidemics/mass casualties	Do not cause epidemics
Symptoms are often delayed several days to weeks	Symptoms may develop within minutes to hours
Examples: Bacillus anthracis bacteria (Anthrax*) Ebola virus Hepatitis B virus HIV Mycobacterium tuberculosis	Examples: Botulinum Ricin (derived from castor beans) Saxitoxin Staphylococcal Enterotoxin B (SEB)

\* Victims infected with Anthrax cannot spread the infection through casual contact.



## Summary of Major Chemical WMDs

Chemical Type	Physical State	Actions	Signs and Symptoms
Nerve agents	Generally liquids with low vapor pressures which freeze at normal temperatures	Interfere with acetylcholinesterase, preventing cells from functioning normally	Twitching; Seizures/Convulsions; Constricted pupils; Diarrhea; Nausea; Vomiting; Respiratory depression and arrest; Paralysis; Drooling; Tearing; Urination
Blister agents	Solids (CX) which readily vaporize or vaporized liquids	Cause blistering to tissue, including skin, eyes and respiratory tract	Burning; Edema of skin and respiratory tract; Eye irritation; Light sensitivity (eyes); Pain
Blood agents	Solids, liquids and gases which are usually dispersed as vaporized liquid or gas	Act by keeping the blood from either absorbing oxygen from the lungs or releasing oxygen to the cells	Deep and rapid breathing; Shortness of breath; Irregular breathing; High blood pressure followed by low blood pressure; Redness; Fast heart rate; Unconsciousness; Death
Choking agents	Gases and liquids which are readily converted to gases	Inhibit breathing by causing choking and gagging	Coughing; Breathing difficulty; Pulmonary edema; Skin blistering; Tearing; Unconsciousness; Death
Vomiting agents	Crystalline solids that release smoke when heated	Cause intense uncontrollable sneezing, coughing, nausea and vomiting. May be released in the presence of another chemical to inhibit wearing of protective breathing equipment.	Sneezing; Coughing; Nausea; Vomiting



## Indicators of WMD Incidents

Both chemical and biological agents can be spread through air, water or surface contact. Dissemination methods are many and varied—from simply opening a container, to using a garden sprayer as a dispersion device, to actually detonating an explosive.

### Chemical Incidents

**Chemical incidents should be suspected if medical symptoms of duress or illness occur quickly, are widespread or involve multiple victims.**

Increased medical calls for the following symptoms could also indicate the occurrence of a chemical incident: nausea; disorientation; difficulty breathing; convulsions; localized sweating; reddening of the eyes and/or skin; and water-like blisters, welts and rashes.

Other indicators of a chemical attack include sudden, disproportionately high death rates:

- Human fatalities—downwind if outside, close to ventilation systems inside
- Dead insects or animals—many dead animals, birds, fish, insects
- Dead vegetation—trees, shrubs, bushes, crops, lawns that are dead or discolored

Other observable clues include unexplained or inconsistent:

- Colored residue (powder, granules)
- Surface contamination, including water with oily droplets/film
- Munitions-like material, especially those containing a liquid substance
- Low-lying vapor clouds or fog-like conditions
- Odors: smells that are sharp, pungent, bitter (like those associated with fruits, flowers, garlic, horseradish, almonds, peaches or mown hay).

Note that the fading of chemical odors does not necessarily indicate reduced vapor concentrations—some chemicals deaden the senses and give a false impression that the chemical is gone.

### Biological Incidents

Biological incidents are harder to determine because symptoms typically do not show up for hours to days (depending on the agent involved). Biological agents have the ability to affect a very large area. Those infected may be unaware that they are contagious, and unknowingly spread the agent well beyond its initial release point. Biological agents do not leave signs. They are usually odorless and colorless, thwarting recognition and identification.

Indicators of a biological attack, although rare, may include the following; unusual/unscheduled spraying, spraying after nightfall, abandoned spray devices, or similar delayed onset of illness seeking medical treatment. Biological agents are usually colorless and odorless.



## Radiological Materials Incidents

Radiological materials include radiological pharmaceuticals, radioactive sensing devices or waste from radioactive industrial sources.

Radioactive materials emit alpha or beta radiation particles or gamma rays. Radioactive materials may be extremely hazardous to fire fighters. They can be inhaled and deposited in body tissues such as the bones, kidneys, liver, lung, and spleen where they can cause severe long-term health impairments. These agents can affect the cells of the body in various negative ways, including destroying them. **Positive pressure SCBA is effective protection against inhaling radioactives, and SFPC provides protection from the penetrative effects of alpha and beta radiation particles.**

In an emergency situation, you may know only that a material is radioactive. You may not know which type of radiation is being emitted. Minimize your exposure to radiation by using time, distance and shielding.

- **Limiting the time** that you are near the source of radiation (e.g., rotate crew to decrease time spent in the hot zone).
- **Increasing the distance between you and the source.** This is the single most important precautionary action. The further a material has to travel to reach you, the weaker it usually becomes.
- **Shield yourself** with appropriate protective clothing or some kind of substantial mass such as earth, concrete or a piece of fire apparatus. Whereas SCBA and bunker gear can shield you from most alpha and beta radiation, lead shielding may be necessary to shield you from gamma rays. Always wear SFPC and SCBA to protect against all avoidable exposures.

External radioactive contamination will continue until any contaminated clothing is decontaminated to remove the radioactive substance. If not decontaminated, exposure and the potential spread of contamination could continue until decontamination takes place or the clothing is removed and disposed of. Once radioactive agents enter the body (internal radioactive contamination), decontamination is not possible.



## Types of Radiological Devices

There are different types of radiological devices:

- **Radiation Dispersal Device (RDD).** A device designed to spread radioactive material through a detonation of conventional explosives or other (non-nuclear) means; also referred to as a “dirty bomb.” [NFPA® 472, 3.3.63.1.2]
- **Radiation Exposure Device (RED).** Radioactive material, either as a sealed source or as material within some type of container, or a radiation-generating device, such as an x-ray device, that directly exposes people to ionizing radiation; the term is interchangeable with the term radiological exposure device or radiation emitting device. [NFPA® 472, 3.3.63.1.3]
- **Improvised Explosive Device (IED).** A bomb that is manufactured from commercial, military or homemade explosives.
- **Improvised Nuclear Device (IND).** An illicit nuclear weapon that is bought, stolen, or otherwise obtained from a nuclear state (that is, a national government with nuclear weapons), or a weapon fabricated from fissile material that is capable of producing a nuclear explosion. [NFPA® 472, 3.3.63.1.1]

## Indicators of Radiological Incidents

Possible indicators of a radiological incident may include:

- Stolen/missing radiological materials
- Compromised/discarded radiological containers
- Unexplained explosions
- Activation of radiological detection devices above background
- Radioactive materials found in occupancies/locations not normally utilizing these materials.

Intentional releases of radioactive material can occur anywhere as a result of a criminal act. A situation that appears to be accidental could indeed be an intentional act. Emergency responders shall assess the radiological emergency to determine if the incident is accidental versus intentional. <sup>1</sup>

<sup>1</sup> ATSM E54 2601 Standard Response to Radiological Response



## Illicit Labs

You may encounter labs where WMDs or drugs are being manufactured. Fire fighters may discover illicit labs when responding to fires, explosions or calls about strange odors. At these locations, you may encounter precursors—raw materials or controlled substances that become part of the final product. Examples of precursors you may encounter at illicit labs include:

- Dimethyl methyl phosphonate
- Dimethyl phosphite
- Potassium fluoride
- Pinacolone and pinacolyl alcohol
- Phosphorus oxychloride

Be alert to the following **clues that indicate a possible illicit lab**:

- Blacked out or covered windows
- Unusual ventilation and drainage systems
- Odors that are pungent, sweet, bitter or leave a metallic taste in your mouth, such as anhydrous ammonia
- Commonly used chemicals (e.g., clear liquids)
- Propane tanks, fuel and lab burners
- Glassware, such as beakers, flasks and mason jars
- Hand scales, distillation equipment
- Batteries, coffee filters
- Increase electrical use

Be aware that **fires involving chemicals can spread faster and burn with more intensity than most structural fires.** The color of the flames may appear unusually bright or dark orange, or the flames may be of several different colors. The color of smoke may be unusual and you may receive reports of unusual odors with the fire. There may also be a flash fire. Being attuned to clues will help you know what you're dealing with, and how to protect yourself. Also remember, incompatible chemicals react upon contact. Many mixtures of incompatible chemicals react violently. It is important to identify incompatible chemicals.

**Booby traps are designed to injure, kill or warn of approach to allow suspects to escape.** Fire, explosion, spike traps, chemical and other physical hazards such as holes in floors that have been covered by rugs are examples of booby traps that have been encountered by responders. Other examples include:

- Trip wires
- Pipe bombs
- Tire-puncturing devices
- Grenades in lamp sockets
- C-4 plastic explosives in VHS cassette
- Shotgun shells wedged in door jams
- Light bulbs filled with gasoline or black powder
- Containers of acids/bases rigged over door openings





## WMD Protective Measures and Response Strategies<sup>1</sup>

When responding to a WMD incident, you should follow these guidelines.

- Consider the safety of yourself and other responders.
- Wear protective clothing and respiratory protection; regardless of the suspected agent, wearing protective clothing and respiratory gear is the first line of defense.
- Maximize distance between you and the suspect agent.
- Minimize exposure time.
- Try to predict the cause of the incident, based on observable clues associated with WMD; call CHEMTREC and other agencies for help identifying chemicals and planning for response.
- Estimate the likely effects; begin and continue risk-benefit analyses.
- Isolate the area and secure the scene.
- Isolate potentially contaminated people, and begin decontamination:
  - Follow standard decontamination procedures (flush-strip-flush).
  - Mass decontamination should begin as soon as possible by utilizing decontamination procedures appropriate for the situation (keeping in mind the safety, security and privacy of all persons involved).
  - If biological agents are involved or suspected, the most important and effective decontamination will be that done within the first one or two minutes; careful brush washing with soap and water will probably be more effective than flushing.
- If you enter the hazard area for a quick in-and-out rescue, try to approach from upwind and uphill, if possible.
- Remember the additional hazards associated with an incident involving criminal or terrorist activity.
  - Secondary threats
  - Water resistance
  - Use of weapons
  - Booby traps
  - Secondary contamination

<sup>1</sup> United States Department of Transportation, Research and Special Programs Administration, Office of Hazardous Materials Initiatives and Training. Emergency Response Guidebook (Washington, DC): 368–371.



## WMD Terminology Matching Exercise

Match the terms below with their corresponding descriptions.



- |                               |                                    |
|-------------------------------|------------------------------------|
| a. Nerve Agents               | e. Irritants (riot control agents) |
| b. Vesicants (blister agents) | f. Biological Agents and Toxins    |
| c. Blood Agents               | g. Explosives                      |
| d. Choking Agents             | h. Radiation                       |

1.	Also known as chemical or cellular asphyxiants, these agents prevent the body's cells from either receiving or using oxygen, depending on the specific agent involved. In either case, cells die rapidly from lack of oxygen. Examples include hydrogen cyanide, cyanogen chloride and arsine.
2.	The equivalent of pesticides for humans, they are the most toxic of the chemical WMDs, with the potential to cause death within minutes of exposure, depending on the concentration. A single drop of the most potent types can cause convulsions, loss of consciousness and death. Examples include tabun, sarin, soman and VX.
3.	These respiratory agents were the first military chemical WMDs, and many are routinely used in common industrial processes. Examples include chlorine and phosgene.
4.	These agents were primarily developed to subdue and gain control over opposing troops without long-term effects. Two types were developed including lacrimators and vomit agents. The lacrimators quickly became popular crowd control tools for law enforcement personnel. Examples include mace, tear gas and pepper spray.
5.	These agents are primarily skin contact hazards resulting in the formation of large blisters. These materials burn and blister the eyes, skin, mucous membranes and the respiratory system (should they be inhaled.) Mild effects may resemble industrial corrosive burns. Examples include mustards, lewisite and phosgene oxime.
6.	Incidents involving these agents will probably unfold gradually, and magnify as time passes. They may affect EMS personnel more than other first responders, with the possibility of pathogens being spread from one person to another. Examples include anthrax, Ebola virus and ricin.
7.	These are materials which threaten responders because they can cause cell changes (ionize).
8.	These are materials used for demolition and excavation, that can rapidly detonate or burn.



Read this case study, and then answer the listed questions and note any concerns or questions.



On April 9, 2001, shortly before 4:00 a.m., fire fighters in Lincoln County, Kentucky respond to a chemical leak from a tank at a large agricultural service company. Upon arrival, responders observe a vapor cloud hanging over a three-acre area, caused by a product flowing from an open valve. The cloud is being temporarily held in place by a flood levy surrounding the plant.

The vapor cloud drifted more than 400 yards and eventually surrounded the first responding units (perhaps the wind changed, or the release rate increased). Five fire fighters were transported to a local hospital for treatment. Responders retreated upwind approximately a half kilometer (quarter of a mile) away from the cloud. Mutual aid from nearby Wain Fleet and West Lincoln counties was called.

Hazardous materials response teams were able to determine the leak was coming from an 18,000-gallon horizontal storage tank of anhydrous ammonia. Fire fighters were able to get upwind from the cloud and move in from the north side, closing the main valve to the tank. Officials believe the major release of anhydrous ammonia, which is used in farming operations, was caused by someone trying to tap the chemical's tank for an illegal methamphetamine laboratory. Someone had sliced through a high-pressure hose to the tank, hack-sawed through the locks on the valves, and then beat the caps off the valves in order to off-load the product. The tank was about 67% full prior to the leak, and dropped to about 60% before the leak could be controlled at the main valve. Investigators later determined that about 200 gallons of anhydrous ammonia had been released.

The initial evacuation effort involved removing residents within a one-mile radius, including a section of Interstate 70. About 250 people were evacuated from about 100 homes and another 5,000 were asked to stay indoors. Fire fighters in full protective gear also drove through the town to make sure that no one remained outdoors during the event.

1. **What is the likely bodily route of entry for the toxin(s) involved?**  
\_\_\_\_\_
2. **Are the response personnel contaminated? Exposed?**  
\_\_\_\_\_
3. **How will the hazardous material(s) behave from a chemical point of view? (E.g., heavier/lighter than air, vaporize slowly/quickly)**  
\_\_\_\_\_
4. **In order to address the health and safety concerns of first responders, what should the initial response include?**  
\_\_\_\_\_
5. **How should decontamination proceed?**  
\_\_\_\_\_



## Matching Clues to the Type of WMD Incidents

Match the following threat/event indicators with the corresponding type of incident. Note some clues may be used more than once.

- |                                |   |
|--------------------------------|---|
| _____ 1. Explosive Incident    | A. Multiple acutely ill victims                       |
| _____ 2. Radiological Incident | B. Unusual glassware/tubing in an occupancy           |
| _____ 3. Illicit Laboratory    | C. Located where first responders are likely to stage |
| _____ 4. Biological Incident   | D. Dispersal equipment found on scene                 |
| _____ 5. Chemical Incident     | E. Large backpack abandoned on bus                    |
| _____ 6. Secondary Threat      | F. Household batteries stripped open for lithium      |
|                                | G. Uranium waste reported stolen                      |
|                                | H. Active shooter(s)                                  |
|                                | I. White powder found in envelope                     |



## Hazard Classes for WMDs

As an emergency responder at the operations level, you should be familiar with the hazard classes associated with WMDs as well as the military abbreviations shown in the table below.

Common Name	Military Abbreviation	UN/DOT Hazard Class
<b><u>Nerve agents:</u></b> <ul style="list-style-type: none"> <li>• Tabun</li> <li>• Sarin</li> <li>• Soman</li> <li>• V agent</li> </ul>	GA GB GD VX	6.1 6.1 6.1 6.1
<b><u>Vesicants (blister agents):</u></b> <ul style="list-style-type: none"> <li>• Mustard</li> <li>• Distilled mustard</li> <li>• Nitrogen mustard</li> <li>• Lewisite</li> </ul>	H HD HN L	6.1 6.1 6.1 6.1
<b><u>Blood agents:</u></b> <ul style="list-style-type: none"> <li>• Hydrogen cyanide</li> <li>• Cyanogen chloride</li> </ul>	AC CK	6.1 2.3
<b><u>Choking agents:</u></b> <ul style="list-style-type: none"> <li>• Chlorine</li> <li>• Phosgene</li> </ul>	CL CG	2.3 2.3
<b><u>Irritants:</u></b> <ul style="list-style-type: none"> <li>• Tear gas</li> <li>• Dibenzoxazepine</li> <li>• Chloroacetophone</li> <li>• Pepper spray, Mace</li>   <li>• Mace, phenylchloromethylketone, chloropicrin</li> </ul>	CS CR CN OC  PS	6.1 6.1 6.1 2.2 (subsequent risk 6.1)  6.1
<b><u>Biological agents and toxins:</u></b> <ul style="list-style-type: none"> <li>• Anthrax</li> <li>• Mycotoxin</li> <li>• Plague</li> <li>• Viral hemorrhagic fevers</li> <li>• Smallpox</li> <li>• Ricin</li> </ul>	Not Applicable	6.2 6.1 or 6.2 6.2 6.2 6.2 6.2

Source: NFPA® 472, Standard for Competence of Responders to Hazardous Materials/ Weapons of Mass Destruction Incidents, 2013 Edition.



Page left blank intentionally.





## Lesson 2.7 - Shipping Papers and Facility Documents

### Lesson Objectives<sup>1</sup>

#### **NFPA® 4.2.1 (10)**

Identify the basic information on safety data sheets (SDS) and shipping papers.

- (a) Identify where to find SDS.
- (b) Identify major sections of an SDS.
- (c) Identify the entries on shipping papers that indicate the presence of hazardous materials.
- (d) Match the name of the shipping papers found in transportation (air, highway, rail and water) with the mode of transportation.
- (e) Identify the person responsible for having the shipping papers in each mode of transportation.
- (f) Identify where the shipping papers are found in each mode of transportation.
- (g) Identify where the papers can be found in an emergency in each mode of transportation.

#### **NFPA® 5.2.2**

Collect hazard and response information using SDS, CHEMTREC/CANUTEC/SETIQ, governmental authorities and shippers and manufacturers.

- (2) Identify two ways to obtain an SDS in an emergency.

#### **NFPA® 5.2.2 (3)**

Using an SDS, identify:

- (a) Physical and chemical characteristics
- (b) Physical hazards of the material
- (c) Health hazards of the material
- (d) Signs and symptoms of exposure
- (e) Routes of entry
- (f) Permissible exposure limits
- (g) Responsible party contact
- (h) Precautions for safe handling
- (i) Applicable control measures
- (j) Emergency and first-aid procedures



All shipments of hazardous materials, as defined by DOT, must be accompanied by shipping papers. Shipping papers vary depending on the mode of transportation. Documents for hazardous materials at fixed sites are also required. These facility documents include (material) safety data sheets (M)SDSs. In this section you will learn how to use shipping papers and facility documents to recognize the presence of hazardous materials.



<sup>1</sup> NFPA 472® Standard for Competence of Responders to Hazardous Materials/Weapons of Mass Destruction, 2013 Edition.



## Shipping Papers

Shipping papers provide detailed information about the contents of the shipment. They signal the presence of hazardous materials through a variety of required entries. Properly completed shipping papers are supposed to describe:

- Name of material, hazard class and division, hazard identification number, container location
- **Packing Group (PG) I, II or III** indicates the degree of danger represented by the material (I = great danger, II = medium danger, III = minor danger).
- **Emergency Contact:** Phone number for shipper or CANUTEC
- The notation **Toxic Inhalation Hazard (TIH)**, is to appear on the shipping papers when a respiratory hazard is present. These hazard zones are meant to categorize hazmat shipments into groups relative to their potential lethality, and serve as a guideline regarding how deadly some agents may become when volatilized.
- Note that **TIH hazard zones are listed in the green section of the ERG.**

<b>READING TRUCKING INC</b> 320 WEST SECOND ST. BOSTON, MA 02170		<b>Non-Negotiable</b> <b>BILL OF LADING</b>	
MC 119444	Fed ID 014-194998	No. 3347408	
1 OF 1			
Date Received: 4/12/14	Diversion No: AL-34	Driver: Worthington	Truck No: 824
SHIPPER		CONSIGNEE	
Name: Service Chemical Company	Name: International Precision Tool Corp		
Street Address: 64 Brookview Court	Street Address: International Drive		
City: Salem	City: Venice	State: Florida	Zip Code: 34293
Phone: 603-609-6098	Company: John B Good	Phone: 800.993.3453	
<b>PARTICULARS FURNISHED SHIPPER</b>			
Units	TIH	Description (Proper Shipping Name, Hazardous Classification, UN/NA Number and Packing Group)	Weight in Lbs.
1 Pail	RQ	UN 3082, Environmentally Hazardous Substance liquid, n.o.s., 9, PG III (Araonic)	60
1 Box	X	UN 2835, Sodium Aluminum Hydride, 4.3, PG II	150
1 Drum	X	UN 1099, Acetone, 3, PG II	215
1 Pail	X	UN 1760, Corrosive liquids, n.o.s. (Octanoyl chloride), 8, PG II	350
12 Skids		Corrugated Fiberboard (kdf)	10,000
1 Skid		Leather (shrink wrapped)	1,350
<b>SHIPPER'S CERTIFICATIONS</b>		Emergency Telephone: 1-900-262-6200	FED No: 171, 136, 127, 154
<input checked="" type="checkbox"/> <b>Dangerous When Wet</b> <small>(RQ) indicates that the packing loading of freight containers and/or transport vehicles containing hazardous materials has been certified in accordance with the provisions of 49 CFR 171.27(c)</small>		<small>This is to certify that the above-named materials are properly classified, described, packaged, marked and labeled, and are in proper condition for transportation according to the applicable federal and international regulations.</small> Signature: <i>John B Good</i>	
<b>LIABILITY FOR LOSS, DAMAGE, ETC. TO GOODS</b>			
Shipper's attention is directed to Section 11 on the reverse side of the Bill of Lading. All goods shall have an agreed release valuation of \$0.10 per pound unless Shipper declares a higher value and Carrier accepts that valuation in the space below. For water carriage, see Section 5 on the reverse side of this Bill of Lading.			
Shipper's Initials: <i>JG</i>		Higher value \$ _____ per pound Carrier's acceptance: <i>(C)</i>	
<b>ORIGIN</b>		<b>DESTINATION</b>	
Time in _____	Time in _____	Received in good order, count and condition unless otherwise noted above.	
Date _____	Date _____		
SHIPPER: <i>John B Good 4/12/14</i>		READING TRUCKING, INC. 4/12/14	
Signature: _____		Signature: _____	
<small>Subject to the terms and conditions on the reverse as well as Carrier's tariff, which may be reviewed at:</small>			

### Key Point

As valuable as shipping papers are, keep in mind that they are not always complete, and sometimes even required entries are missing.



## Shipping Papers by Mode of Transportation

<b>Transport Mode</b>	<b>Type of Shipping Paper</b>	<b>Location of Shipping Paper</b>	<b>Responsible Party</b>
Highway	Bill of Lading or Freight Bill	Cab of vehicle within reach of the driver	Driver
Rail	Consist and/or Waybill	Locomotive	Conductor or Engineer
Water	Dangerous Cargo Manifest	Wheelhouse or pipe-like container on barge	Captain or Master
Air	Air Bill with Shipper's Certification for Restricted Articles	Cockpit (may also be outside of packages or attached to the outside of packages)	Pilot

Sample shipping papers are provided on the following pages.



Example of a Bill of Lading

<p><b>READING TRUCKING INC</b> 220 WEST SECOND ST. BOSTON, MA 02170</p> <p>Phone 1-800-223-3030 Fax 800-231-8090</p> <p>MC 119444 Fed ID 014-1049808</p>	<h2 style="margin: 0;">Non-Negotiable BILL OF LADING</h2> <p style="font-size: 1.2em; margin: 5px 0;">No. 3347408</p> <p style="margin: 5px 0;">1 OF 1</p>																																																				
<table border="1" style="width: 100%; border-collapse: collapse;"> <tr> <td style="width: 16.6%;">Date Received: 4/12/14</td> <td style="width: 16.6%;">Dispatch/Pro No: AL-34</td> <td style="width: 16.6%;">Driver: Worthington</td> <td style="width: 16.6%;">Truck No: B24</td> <td style="width: 16.6%;">Trailer No: NOZZ 234213</td> </tr> </table>	Date Received: 4/12/14	Dispatch/Pro No: AL-34	Driver: Worthington	Truck No: B24	Trailer No: NOZZ 234213																																																
Date Received: 4/12/14	Dispatch/Pro No: AL-34	Driver: Worthington	Truck No: B24	Trailer No: NOZZ 234213																																																	
<b>SHIPPER</b>	<b>CONSIGNEE</b>																																																				
<table border="1" style="width: 100%; border-collapse: collapse;"> <tr> <td style="width: 50%;">Name: Service Chemical Company</td> <td style="width: 50%;">Name: International Precision Tool Corp</td> </tr> <tr> <td>Street Address: 64 Brookview Court</td> <td>Street Address: International Drive</td> </tr> <tr> <td>City: Salem State: NH Zip Code: 03079</td> <td>City: Venice State: Florida Zip Code: 34293</td> </tr> <tr> <td>Phone: 603-809-6008</td> <td>Notify/Contact: John B Good Phone: 800 333-3453</td> </tr> </table>	Name: Service Chemical Company	Name: International Precision Tool Corp	Street Address: 64 Brookview Court	Street Address: International Drive	City: Salem State: NH Zip Code: 03079	City: Venice State: Florida Zip Code: 34293	Phone: 603-809-6008	Notify/Contact: John B Good Phone: 800 333-3453																																													
Name: Service Chemical Company	Name: International Precision Tool Corp																																																				
Street Address: 64 Brookview Court	Street Address: International Drive																																																				
City: Salem State: NH Zip Code: 03079	City: Venice State: Florida Zip Code: 34293																																																				
Phone: 603-809-6008	Notify/Contact: John B Good Phone: 800 333-3453																																																				
<b>PARTICULARS FURNISHED SHIPPER</b>																																																					
<table border="1" style="width: 100%; border-collapse: collapse;"> <thead> <tr> <th style="width: 5%;">Units</th> <th style="width: 5%;">HM</th> <th style="width: 70%;">Description, Proper Shipping Name, Hazardous Classification, UN/NA Number and Packing Group</th> <th style="width: 15%;">Weight in Lbs.</th> </tr> </thead> <tbody> <tr> <td>1</td> <td>RQ</td> <td>UN 3082, Environmentally Hazardous Substance liquid, n.o.s., 9, PG III (Arsenic)</td> <td>60</td> </tr> <tr> <td>1</td> <td>X</td> <td>UN 2835; Sodium Aluminium Hydride; 4.3; PG II</td> <td>150</td> </tr> <tr> <td>1</td> <td>X</td> <td>UN 1090; Acetone; 3; PG II</td> <td>215</td> </tr> <tr> <td>1</td> <td>X</td> <td>UN 1760, Corrosive liquids, n.o.s. (Octanoyl chloride), 8, PG II</td> <td>350</td> </tr> <tr> <td>12</td> <td></td> <td>Corrugated Fiberboard (kdf)</td> <td>10,000</td> </tr> <tr> <td>1</td> <td></td> <td>Leather (shrink wrapped)</td> <td>1,350</td> </tr> <tr><td> </td><td> </td><td> </td><td> </td></tr> <tr><td> </td><td> </td><td> </td><td> </td></tr> <tr><td> </td><td> </td><td> </td><td> </td></tr> <tr><td> </td><td> </td><td> </td><td> </td></tr> <tr><td> </td><td> </td><td> </td><td> </td></tr> <tr><td> </td><td> </td><td> </td><td> </td></tr> </tbody> </table>		Units	HM	Description, Proper Shipping Name, Hazardous Classification, UN/NA Number and Packing Group	Weight in Lbs.	1	RQ	UN 3082, Environmentally Hazardous Substance liquid, n.o.s., 9, PG III (Arsenic)	60	1	X	UN 2835; Sodium Aluminium Hydride; 4.3; PG II	150	1	X	UN 1090; Acetone; 3; PG II	215	1	X	UN 1760, Corrosive liquids, n.o.s. (Octanoyl chloride), 8, PG II	350	12		Corrugated Fiberboard (kdf)	10,000	1		Leather (shrink wrapped)	1,350																								
Units	HM	Description, Proper Shipping Name, Hazardous Classification, UN/NA Number and Packing Group	Weight in Lbs.																																																		
1	RQ	UN 3082, Environmentally Hazardous Substance liquid, n.o.s., 9, PG III (Arsenic)	60																																																		
1	X	UN 2835; Sodium Aluminium Hydride; 4.3; PG II	150																																																		
1	X	UN 1090; Acetone; 3; PG II	215																																																		
1	X	UN 1760, Corrosive liquids, n.o.s. (Octanoyl chloride), 8, PG II	350																																																		
12		Corrugated Fiberboard (kdf)	10,000																																																		
1		Leather (shrink wrapped)	1,350																																																		
<table border="1" style="width: 100%; border-collapse: collapse;"> <tr> <td style="width: 30%;"><b>SHIPPER'S CERTIFICATIONS</b></td> <td style="width: 20%;">Placards Required: Dangerous When Wet</td> <td style="width: 20%;">Emergency Telephone: 1-800-262-8200</td> <td style="width: 30%;">ERG No. 171, 138, 127, 154</td> </tr> <tr> <td colspan="2"> <small>Shipper declares that the packing/ loading of freight containers and/or transport vehicles containing hazardous materials has been carried out in accordance with the provisions of 49 C.F.R. §176.27(c).</small> </td> <td colspan="2"> <small>This is to certify that the above-named materials are properly classified, described, packaged, marked and labeled, and are in proper condition for transportation according to the applicable national and international regulations.</small> </td> </tr> <tr> <td colspan="2">Signature: <u>John Jones</u></td> <td colspan="2">Signature: <u>John Jones</u></td> </tr> </table>		<b>SHIPPER'S CERTIFICATIONS</b>	Placards Required: Dangerous When Wet	Emergency Telephone: 1-800-262-8200	ERG No. 171, 138, 127, 154	<small>Shipper declares that the packing/ loading of freight containers and/or transport vehicles containing hazardous materials has been carried out in accordance with the provisions of 49 C.F.R. §176.27(c).</small>		<small>This is to certify that the above-named materials are properly classified, described, packaged, marked and labeled, and are in proper condition for transportation according to the applicable national and international regulations.</small>		Signature: <u>John Jones</u>		Signature: <u>John Jones</u>																																									
<b>SHIPPER'S CERTIFICATIONS</b>	Placards Required: Dangerous When Wet	Emergency Telephone: 1-800-262-8200	ERG No. 171, 138, 127, 154																																																		
<small>Shipper declares that the packing/ loading of freight containers and/or transport vehicles containing hazardous materials has been carried out in accordance with the provisions of 49 C.F.R. §176.27(c).</small>		<small>This is to certify that the above-named materials are properly classified, described, packaged, marked and labeled, and are in proper condition for transportation according to the applicable national and international regulations.</small>																																																			
Signature: <u>John Jones</u>		Signature: <u>John Jones</u>																																																			
<b>LIABILITY FOR LOSS, DAMAGE, ETC. TO GOODS</b>																																																					
<p>Shipper's attention is directed to Section 11 on the reverse side of this Bill of Lading. All goods shall have an agreed release valuation of \$0.10 per pound unless Shipper declares a higher value and Carrier accepts that valuation in the space below. For water carriage, see Section 5 on the reverse side of this Bill of Lading.</p> <p>Shipper's initials: <u>JD</u> Higher value: \$ _____ per pound Carrier's acceptance: <u>RD</u></p>																																																					
<table style="width: 100%;"> <tr> <td style="width: 50%; text-align: center;"><b>ORIGIN</b></td> <td style="width: 50%; text-align: center;"><b>DESTINATION</b></td> </tr> <tr> <td>time in : _____</td> <td>time in : _____</td> </tr> <tr> <td>time out: _____</td> <td>time out: _____</td> </tr> <tr> <td>date : _____</td> <td>date : _____</td> </tr> </table> <p style="text-align: right; font-size: 0.8em;">Received in good order, count and condition unless otherwise noted above.</p>		<b>ORIGIN</b>	<b>DESTINATION</b>	time in : _____	time in : _____	time out: _____	time out: _____	date : _____	date : _____																																												
<b>ORIGIN</b>	<b>DESTINATION</b>																																																				
time in : _____	time in : _____																																																				
time out: _____	time out: _____																																																				
date : _____	date : _____																																																				
<table border="1" style="width: 100%; border-collapse: collapse;"> <tr> <td style="width: 50%;"><b>SHIPPER</b></td> <td style="width: 50%;"><b>READING TRUCKING, INC.</b></td> <td style="width: 50%;"><b>CONSIGNEE</b></td> </tr> <tr> <td>Signature: <u>John Jones</u></td> <td>Signature: <u>John Worthington</u></td> <td>Signature: _____</td> </tr> <tr> <td>Date: <u>4/12/14</u></td> <td>Date: <u>4/12/14</u></td> <td>Date: _____</td> </tr> </table>	<b>SHIPPER</b>	<b>READING TRUCKING, INC.</b>	<b>CONSIGNEE</b>	Signature: <u>John Jones</u>	Signature: <u>John Worthington</u>	Signature: _____	Date: <u>4/12/14</u>	Date: <u>4/12/14</u>	Date: _____																																												
<b>SHIPPER</b>	<b>READING TRUCKING, INC.</b>	<b>CONSIGNEE</b>																																																			
Signature: <u>John Jones</u>	Signature: <u>John Worthington</u>	Signature: _____																																																			
Date: <u>4/12/14</u>	Date: <u>4/12/14</u>	Date: _____																																																			
<p><i>Subject to the terms and conditions on the reverse as well as Carrier's tariff, which may be reviewed at:</i></p>																																																					





Example of a Consist (Train List or Wheel Report)

CARS LISTED FROM REAR OF TRAIN									
TRAIN/JOB	QHONL	13 WITH FOLLOWING CARS				HOUSTON TX	TIME- 06/14 1405		
SEQ	EQUIPMENT	ID	KND	COMDTY	DESTN	ZTS/CARR	NXBLK	CITY/STATE	CONSIGNEE
BLOCK-- NLRK X 344									
1	CNW	718486	LD5C	BRICK	TP570 15-770-00	60-MPH 122-TONS 60-FT 1-P		FTWR	DELRIO TX MOORE LBR 1.0 BRK 122-ATONS 60-AFT
2	CRLE	20684	LG5L	PIPE	TP570	60-MPH 81-TONS 58-FT 1-P		ODES	ODESSA TX RED MAN PI 1.0 BRK 203-ATONS 118-AFT
3	MP	782062	LJ-40	SUGAR	TP-250 BNSF	60-MPH 122-TONS 58-FT 1-P		BNSF	MILCREEK OK MERIDI AGG 1.0 BRK 325-ATONS 176-AFT
4	UPFE	464323	LRPL	CHCKN	PX950	70-MPH 96-TONS 64-FT 1-P		WCTN	OAKLAND CA PACIFI TRA 1.0 BRK 421-ATONS 240-AFT
PS R705 MAINT 10 DEG BELOW 0 PROTECTIVE SERVICE									
MPS 705 MAINTAIN 10 DEGREE BELOW									
5	SSPX	1010	LC5P	SLAG	TP218 05-793-00	60-MPH 126-TONS 42-FT 1-P		MLYD	DALLAS TX LONE STA I 1.0 BRK 547-ATONS 282-AFT
6	UP	87038	EC4T	E	061 07-800-00	60-MPH 31-TONS 60-FT 1-P		PBSW	MONSANTO AR EL DOR CHE 1.0 BRK 683-ATONS 342-AFT
*****									
* DANGEROUS *									
*****									
EMERGENCY CONTACT : EL DORADO CHEMICAL									
800-424-9300									
1/NC									
RESIDUE: LAST CONTAINED									
AMMONIUM NITRATE									
5.1									
UN1942									
PGIII									
HAZMAT STCC = 4918311									
7	ATX	32303	LT19	RGMATL	TO570 16ZC252	60-MPH 110-TONS 50-FT 1-P		SELKBRIDGE	PORNJ SOLUTIA 1.0 BRK 793-ATONS 392-AFT
*****									
* * *									
*****									
LIQUID, N. O. S.									
(PHTHALIC ANHYDRIDE)									
EMERGENCY CONTACT : STERLING CHEMICAL									
800-424-9300									
1/TC 180000/LB									
ELEVATED TEMPERATURE									
9									
UN3257									
PGIII									
RQ (PHTHALIC ANHYDRIDE)									
HAZMAT STCC = 4960156									
8	NATX	33020	LT32	LPG	TP460 18C 003	60-MPH 128-TONS 68-FT 1-P		CWAY	FTWR WELIZABETPA HERCULES 1.0 BRK 921-ATONS 460-AFT
*****									
* DANGEROUS *									
*****									
EMERGENCY CONTACT : CHEMTREC									
1-800-424-9300									
1/CL 30937/GA									
LIQUIFIED PETROLEUM GAS									
2.1.									
UN1075									
HAZMAT STCC = 4905752									



### Example of a Dangerous Cargo Manifest

DANGEROUS CARGO MANIFEST							
VESSEL: GITTA OLDENDORFF V.03012				OFFICIAL NUMBER OR CALL SIGN: ELW07			
FLAG OF REGISTRY: LIBERIAN				GROSS: 30,995.00		NETT: 14,095.00	
PORT OF DISCHARGE: NEW ORLEANS				MASTER: CAPT. RYAN NEILSON			
PORT OF LOADING: TANJUNG PRIOK, JAKARTA				PAGE: ONE		OF: ONE	
CONTAINER NO	NOS & DESC OF PKGS	GROSS WEIGHT KGS OR LBS	TRUE SHIPPING NAME	CLASSIFICATION	LABEL	EMERG. RESP TEL NUMBER	STOWAGE
LHCU 2960555	1 X 20' PACKED IN : 10 PALLETS 150 FIBER DRUMS	7,860 KGS	15,000 LBS UNICELL-H (TSH) PROPER SHIPPING NAME : SELF REACTIVE SOLID TYPE D FLASH POINT : N/A	IMO CLASS : 4.1 UN NO : 3226 PACKING GROUP : II	FLAMM SOLID	62-21-6514730	771072
RNCU 4543768	1 ISO TANK	21,511 KGS	PARA NITRO TOLUENE	C/L,6.1,UN 1684 PKG, II, IMDG PG 6211 EHS: 6.1-02 MFAG - 335	TOXIC	1-228-937-2222	770884
TAMU 100976	1 X 20' PACKED IN : 8 PALLETS 76 DRUMS	17,138 KGS	TOXIC LIQUID, ORGANIC, N.O.S. TOLUENESULFONIC ACID METHYL ESTER	C/L,6.2,UN 2810 PKG III, IMDG PG. 6270 EHS: MFAG:	TOXIC	412-353-7437	532084
PREPARED BY: Renny Levita				DATE: 11/6/02		APPROVED BY: Neilson	
MASTER MARITIME SERVICE LTD.						DATE: 11/7/02	
						CH / OFF	





## Example of an Air Bill or a Shipper's Declaration for Dangerous Goods

SHIPPER'S DECLARATION FOR DANGEROUS GOODS							
(Provide at least two copies to the airline)							
Shipper	Custom Materials, Inc 2423 U. S. Hwy 90 East Houston TX 77373	Air Waybill No.	012-1303-2202				
			Page 1 of 1 Pages				
			Shipper's Reference Number PROJ. 400134R02-SP				
Consignee	SKYLAR CUSTOM APPLICATIONS 286 SYDNEY DRIVE ANCHORAGE, ALASKA 670-479-5758						
Two completed and signed copies of this Declaration must Be handed to the operator		WARNING					
TRANSPORT DETAILS		Failure to comply in all respects with the applicable Dangerous Goods Regulations may be in breach of the applicable law, subject to penalties. This Declaration must not, in any circumstances, be completed and/or signed by a consolidator, a forwarder or an IATA agent.					
This shipment is within the limitations prescribed for: (delete non-applicable) Passenger and Cargo Aircraft XXXXXXXXXXXX	Airport of Departure  IAH	Shipment type: (delete non-applicable) XXXXXXXXXX NON-RADIOACTIVE					
Airport of Destination: ANC							
NATURE AND QUANTITY OF DANGEROUS GOODS							
Dangerous Goods Identification							
Proper Shipping Name	Class or	UN or Division	Packing ID No.	Subsidiary Group	Quantity and Type of packing Risk	Pack.	Authorization Inst.
HELIUM, COMPRESSED	2.2	UN1046	II	N/A	1 PLYWOOD BOX X 0.75 KGS. OVERPACK USED X 1 CRATE# 2	200	DSS
PAINT & PAINT RELATED MATERIALS	3	UN1263	III	N/A	1 PLYWOOD BOX X 28 KGS. CRATE# 1	200	DSS
AMINES, SOLID CORROSIVE N.O.S. (TETRAETHYLENE- PENTAMINE)	8	UN3259	II	N/A	1 WOODEN CRATE X 43 KGS. CRATE# 3	200	DSS
Additional Handling Information: INNER PACKAGES COMPLY WITH PRESCRIBED SPECIFICATIONS PREPARED UNDER IATA REGULATIONS							
					1-800-424-9300 (U. S.) 24 hr Emergency Contact Tel. No. (011) (1) 713-572-8773 (INT'L)		
I hereby declare that the contents of this consignment are fully and accurately described above by the proper shipping name and are classified, packed, marked and labeled/placarded and are in all aspects in proper condition for transport according to all applicable international and national government regulations					Name/Title of Signatory HAZEL JUANITA OFFICE MGR. Place and Date HOUSTON, TX JUNE 12, 2003 Signature  <i>H. Juanita</i>		



Page left blank intentionally.



## Safety Data Sheets

The OSHA regulations require manufacturers of controlled products to provide the end users with a safety data sheet (SDS), which provides the information they need to work with the product safely. A copy of all SDSs for products used at that location must be available on site.

Currently SDSs may take many forms, but they will always include the following information:

- Chemical name
- Hazardous ingredients/chemical identity
- Physical characteristics
- Fire and explosion data
- Reactivity
- Health hazards
- Usage, handling and storage
- Special protection and precautions

SDSs are made available to local emergency responders for pre-incident planning. Any pre-incident plan should include information on where the facilities in a specific jurisdiction keep SDSs. SDSs may be kept in a central location (for example, an office some distance from the storage building), or they may be kept in a container on-site that is set aside specifically for use by emergency responders. Obviously, if a location has not been subjected to pre-incident planning, no guidance will exist for specifically where to look for any SDSs.

Recently, Canada, the United States and other United Nations' members adopted the Globally Harmonized System. (See the next page.) The adoption of the GHS will impact the look of, and the information in SDSs. Globally harmonized safety data sheets (SDSs), as they will be referred to, will contain the following information in the order listed here.<sup>1</sup>

1. Identification of the substance or mixture and of the supplier
2. Hazards identification
3. Composition/information on ingredients
4. First aid measures
5. Fire fighting measures
6. Accidental release measures
7. Handling and storage
8. Exposure controls/personal protection
9. Physical and chemical properties
10. Stability and reactivity
11. Toxicological information
12. Ecological information
13. Disposal considerations
14. Transport information
15. Regulatory information
16. Other information including information on preparation and revision of the SDS

<sup>1</sup> <http://www.osha.gov/dsg/hazcom/ghs.html#4.8> (retrieved June 14, 2013).



# OSHA<sup>®</sup> QUICK CARD<sup>™</sup>

## Hazard Communication Safety Data Sheets

The Hazard Communication Standard (HCS) requires chemical manufacturers, distributors, or importers to provide Safety Data Sheets (SDSs) (formerly known as Material Safety Data Sheets or MSDSs) to communicate the hazards of hazardous chemical products. As of June 1, 2015, the HCS will require new SDSs to be in a uniform format, and include the section numbers, the headings, and associated information under the headings below:

**Section 1, Identification** includes product identifier; manufacturer or distributor name, address, phone number; emergency phone number; recommended use; restrictions on use.

**Section 2, Hazard(s) identification** includes all hazards regarding the chemical; required label elements.

**Section 3, Composition/information on ingredients** includes information on chemical ingredients; trade secret claims.

**Section 4, First-aid measures** includes important symptoms/effects, acute, delayed; required treatment.

**Section 5, Fire-fighting measures** lists suitable extinguishing techniques, equipment; chemical hazards from fire.

**Section 6, Accidental release measures** lists emergency procedures; protective equipment; proper methods of containment and cleanup.

**Section 7, Handling and storage** lists precautions for safe handling and storage, including incompatibilities.

*(Continued on other side)*

For more information:



U.S. Department of Labor

[www.osha.gov](http://www.osha.gov) (800) 321-OSHA (6742)

OSHA 3493-02 2012



# OSHA<sup>®</sup> QUICK CARD<sup>™</sup>

## Hazard Communication Safety Data Sheets

**Section 8, Exposure controls/personal protection** lists OSHA's Permissible Exposure Limits (PELs); Threshold Limit Values (TLVs); appropriate engineering controls; personal protective equipment (PPE).

**Section 9, Physical and chemical properties** lists the chemical's characteristics.

**Section 10, Stability and reactivity** lists chemical stability and possibility of hazardous reactions.

**Section 11, Toxicological information** includes routes of exposure; related symptoms, acute and chronic effects; numerical measures of toxicity.

Section 12, Ecological information\*

Section 13, Disposal considerations\*

Section 14, Transport information\*

Section 15, Regulatory information\*

**Section 16, Other information**, includes the date of preparation or last revision.

\*Note: Since other Agencies regulate this information, OSHA will not be enforcing Sections 12 through 15 (29 CFR 1910.1200(g)(2)).

**Employers must ensure that SDSs are readily accessible to employees.**

See Appendix D of 29 CFR 1910.1200 for a detailed description of SDS contents.

For more information:



U.S. Department of Labor

[www.osha.gov](http://www.osha.gov) (800) 321-OSHA (6742)

OSHA 3493-02-2012



## SDS Documentation



With your team, discuss and determine these information items for your assigned chemical. Use any appropriate reference materials and the SDSs for chlorine and nitric acid that are located on the pages that follow. During the report-back, be sure to correct your answers, if needed, and write in the appropriate response for the chemical addressed by the other team.

Hazard and Response Information	Chlorine	Nitric Acid
a. Physical and chemical characteristics		
b. Fire and explosion data		
c. Health hazards		
d. Signs and symptoms of exposure		
e. Routes of entry		
f. Exposure limits		
g. Manufacturer/Contact Information		
h. Precautions for safe handling		
i. Applicable control measures, PPE		
j. Emergency and first-aid procedures		





Hazard and Response Information	Anhydrous Ammonia	Unleaded Gasoline
a. Physical and chemical characteristics		
b. Fire and explosion data		
c. Health hazards		
d. Signs and symptoms of exposure		
e. Routes of entry		
f. Exposure limits		
g. Manufacturer/Contact Information		
h. Precautions for safe handling		
i. Applicable control measures, PPE		
j. Emergency and first-aid procedures		



**MATHESON**

ask. . .The Gas Professionals™

## Safety Data Sheet

Material Name: CHLORINE

SDS ID: MAT04600

### \*\*\* Section 1 - IDENTIFICATION\*\*\*

#### Manufacturer Information

MATHESON TRI-GAS, INC.  
150 Allen Road, Suite 302  
Basking Ridge, NJ 07920

General Information: 1-800-416-2505  
Emergency #: 1-800-424-9300 (CHEMTREC)  
Outside the US: 703-527-3887 (Call collect)

#### Product Identifier: CHLORINE

##### Trade Names/Synonyms

MTG MSDS 22; CHLORINE MOLECULAR; DIATOMIC CHLORINE; DICHLORINE; MOLECULAR CHLORINE;  
UN 1017; Cl<sub>2</sub>; RTECS: FO2100000

##### Chemical Family

halogens, gas

##### Product Use

industrial

##### Restrictions on Use

None known.

### \*\*\* Section 2 - HAZARDS IDENTIFICATION\*\*\*

#### GHS Classification

- Oxidizing gas, Category 1
- Gas under pressure, Liquefied gas
- Acute toxicity, Category 2
- Skin corrosion/irritation, Category 1
- Eye damage/irritation, Category 1
- Specific target organ systemic toxicity following single exposure, Category 1
- Specific target organ systemic toxicity following repeated exposure, Category 1
- Hazardous to the aquatic environment - acute hazard, Category 1

#### GHS LABEL ELEMENTS

##### Symbol(s)



##### Signal Word

DANGER

##### Hazard Statement(s)

- May cause or intensify fire; oxidizer
- Contains gas under pressure; may explode if heated
- Fatal if inhaled
- Causes severe skin burns and eye damage
- Causes serious eye damage



## Safety Data Sheet

Material Name: CHLORINE

SDS ID: MAT04600

Causes damage to organs  
Causes damage to organs through prolonged or repeated exposure  
Very toxic to aquatic life

### Precautionary Statement(s)

Keep away from clothing and other combustible materials. Do not breathe gas, fumes, vapor, or spray. Do not eat, drink, or smoke when using this product. Keep reduction valves free from grease and oil. Wear respiratory protection. Wear protective gloves/clothing and eye/face protection. Use only outdoors or in a well-ventilated area. In case of fire, stop leak if safe to do so. Wash thoroughly after handling. Avoid release to the environment. IF IN EYES: Rinse cautiously with water for several minutes. Remove contact lenses, if present and easy to do. Continue rinsing. IF SWALLOWED: Rinse mouth. Do NOT induce vomiting. IF INHALED: Remove victim to fresh air and keep at rest in a position comfortable for breathing. IF ON SKIN (or hair): Remove/take off immediately all contaminated clothing. Rinse skin with water/shower. Wash contaminated clothing before reuse. Immediately call a POISON CENTER or doctor/physician. Specific treatment is urgent, see first aid section of Safety Data Sheet. Store locked up. Keep container tightly closed. Store in a well-ventilated place. Protect from sunlight. Collect spillage. Dispose in accordance with all applicable regulations.

### \*\*\* Section 3 - COMPOSITION / INFORMATION ON INGREDIENTS\*\*\*

CAS#	Component	Percent
7782-50-5	CHLORINE	100

### \*\*\* Section 4 - FIRST AID MEASURES\*\*\*

#### Inhalation

If adverse effects occur, remove to uncontaminated area. Give artificial respiration if not breathing. If breathing is difficult, oxygen should be administered by qualified personnel. Get immediate medical attention.

#### Skin

Wash skin with soap and water for at least 15 minutes while removing contaminated clothing and shoes. Get immediate medical attention. Thoroughly clean and dry contaminated clothing before reuse. Destroy contaminated shoes.

#### Eyes

Immediately flush eyes with plenty of water for at least 15 minutes. Then get immediate medical attention.

#### Ingestion

If a large amount is swallowed, get medical attention.

#### Note to Physicians

For inhalation, consider oxygen.  
Avoid gastric lavage or emesis.

#### Symptoms: Immediate

respiratory tract burns, skin burns, eye burns, respiratory system effects, central nervous system effects

#### Symptoms: Delayed

respiratory tract burns, skin burns, eye burns, kidney damage, tooth erosion, respiratory system effects

### \*\*\* Section 5 - FIRE FIGHTING MEASURES\*\*\*

See Section 9 for Flammability Properties

#### Specific Hazards Arising from the Chemical

Oxidizer. May ignite or explode on contact with combustible materials. Containers may rupture or explode if exposed to heat.

#### Extinguishing Media

water



## Safety Data Sheet

Material Name: CHLORINE

SDS ID: MAT04600

Large fires: Flood with fine water spray.

### Unsuitable Extinguishing Media

Do not use dry chemicals, carbon dioxide or halogenated extinguishing agents.

### Protective Equipment and Precautions for Firefighters

Wear full protective fire fighting gear including self contained breathing apparatus (SCBA) for protection against possible exposure.

### Fire Fighting Measures

Move container from fire area if it can be done without risk. Cool containers with water spray until well after the fire is out. Stay away from the ends of tanks. For fires in cargo or storage area: If this is impossible then take the following precautions: Keep unnecessary people away, isolate hazard area and deny entry. Let the fire burn. For small fires, contain and let burn. Use extinguishing agents appropriate for surrounding fire. Cool containers with water spray until well after the fire is out. Apply water from a protected location or from a safe distance. Avoid inhalation of material or combustion by-products. Stay upwind and keep out of low areas. Evacuation radius: 800 meters (1/2 mile).

### Hazardous Combustion Products

**Water or Moisture:** hypochlorous acid, hydrochloric acid

## \*\*\* Section 6 - ACCIDENTAL RELEASE MEASURES\*\*\*

### Personal Precautions

Wear personal protective clothing and equipment, see Section 8.

### Environmental Precautions

Avoid release to the environment. Keep out of water supplies and sewers. Notify Local Emergency Planning Committee and State Emergency Response Commission for release greater than or equal to RQ (U.S. SARA Section 304). If release occurs in the U.S. and is reportable under CERCLA Section 103, notify the National Response Center at (800)424-8802 (USA) or (202)426-2675 (USA).

### Methods for Containment

Leaking gas fire: Do not extinguish, unless leak can be stopped safely. Eliminate all ignition sources if safe to do so. Reduce vapors with water spray.

### Cleanup Methods

Stop leak if safe to do so - Prevent entry into waterways, drains, or confined areas. Do not touch spilled material. Eliminate all ignition sources if safe to do so. Keep unnecessary people away, isolate hazard area and deny entry. Ventilate closed spaces before entering. Damaged cylinders should be handled only by specialists.

## \*\*\* Section 7 - HANDLING AND STORAGE\*\*\*

### Handling Procedures

Subject to handling regulations: U.S. OSHA 29 CFR 1910.119.

### Storage Procedures

Store and handle in accordance with all current regulations and standards. Protect from physical damage. Keep separated from incompatible substances. Store outside or in a detached building. NFPA 430 Code for the Storage of Liquid and Solid Oxidizing Materials. Store in a cool, dry place. Store in a well-ventilated area. Protect from sunlight. Subject to storage regulations: U.S. OSHA 29 CFR 1910.101. Notify State Emergency Response Commission for storage or use at amounts greater than or equal to the TPQ (U.S. EPA SARA Section 302). SARA Section 303 requires facilities storing a material with a TPQ to participate in local emergency response planning (U.S. EPA 40 CFR 355 Part B).

**Incompatibilities** combustible materials, bases, metals, halogens, metal salts, reducing agents, amines, metal carbide, metal oxides, oxidizing materials, halo carbons, acids, arsenic, calcium, iodine, mercuric oxide, ethers, fluorine





## Safety Data Sheet

Material Name: CHLORINE

SDS ID: MAT0460

### \*\*\* Section 8 - EXPOSURE CONTROLS / PERSONAL PROTECTION\*\*\*

#### Component Exposure Limits

##### CHLORINE (7782-50-5)

**ACGIH:** 0.5 ppm TWA  
1 ppm STEL

**Europe:** 0.5 ppm STEL; 1.5 mg/m<sup>3</sup> STEL

**OSHA (Final):** 1 ppm Ceiling; 3 mg/m<sup>3</sup> Ceiling

**OSHA (Vacated):** 0.5 ppm TWA; 1.5 mg/m<sup>3</sup> TWA  
1 ppm STEL; 3 mg/m<sup>3</sup> STEL

**NIOSH:** 0.5 ppm Ceiling (15 min); 1.45 mg/m<sup>3</sup> Ceiling (15 min)

#### Component Biological Limit Values

There are no biological limit values for any of this product's components.

#### IDLH

10 ppm

#### Engineering Controls

Ensure adequate ventilation. Ensure compliance with applicable exposure limits.

#### PERSONAL PROTECTIVE EQUIPMENT

##### Eyes/Face

Wear splash resistant safety goggles with a faceshield. Provide an emergency eye wash fountain and quick drench shower in the immediate work area.

##### Protective Clothing

Wear appropriate chemical resistant clothing. For the liquid: Wear appropriate protective, cold insulating clothing.

##### Glove Recommendations

Wear appropriate chemical resistant gloves.

##### Respiratory Protection

The following respirators and maximum use concentrations are drawn from NIOSH and/or OSHA.

5 ppm

Any air-purifying half-mask respirator equipped with cartridge(s) providing protection against the compound of concern.

Any supplied-air respirator.

10 ppm

Any supplied-air respirator operated in a continuous-flow mode.

Any powered, air-purifying respirator with cartridge(s) providing protection against this substance.

Any air-purifying respirator with a full facepiece and a canister providing protection against this substance.

Any air-purifying full-facepiece respirator (gas mask) with a chin-style, front-mounted or back-mounted canister providing protection against the compound of concern.

Any self-contained breathing apparatus with a full facepiece.

Any supplied-air respirator with a full facepiece.

Emergency or planned entry into unknown concentrations or IDLH conditions -

Any self-contained breathing apparatus that has a full facepiece and is operated in a pressure-demand or other positive-pressure mode.

Any supplied-air respirator with a full facepiece that is operated in a pressure-demand or other positive-pressure mode in combination with an auxiliary self-contained breathing apparatus operated in pressure-demand or other positive-pressure mode.

Escape -

Any air-purifying full-facepiece respirator (gas mask) with a chin-style, front-mounted or back-mounted canister providing protection against the compound of concern.



## Safety Data Sheet

Material Name: CHLORINE

SDS ID: MAT04600

Any appropriate escape-type, self-contained breathing apparatus.

### \*\*\* Section 9 - PHYSICAL AND CHEMICAL PROPERTIES\*\*\*

<b>Physical State:</b> Gas	<b>Appearance:</b> Not available
<b>Color:</b> yellow or green	<b>Physical Form:</b> gas
<b>Odor:</b> distinct odor, irritating odor	<b>Odor Threshold:</b> 0.01 ppm
<b>pH:</b> Not available	<b>Melting/Freezing Point:</b> -101 °C
<b>Boiling Point:</b> -35 °C	<b>Flash Point:</b> not flammable
<b>Decomposition:</b> Not available	<b>Evaporation Rate:</b> Not available
<b>Vapor Pressure:</b> 5168 mmHg @ 21 °C	<b>Vapor Density (air = 1):</b> 2.49
<b>Density:</b> 3.214 g/L @ 0 °C	<b>Specific Gravity (water=1):</b> 1.5649 @ -35 °C (liquid)
<b>Water Solubility:</b> 1.46 % @ 0 °C	<b>Log KOW:</b> Not available
<b>Auto Ignition:</b> Not available	<b>Viscosity:</b> 0.01327 cP @20 °C
<b>Molecular Weight:</b> 70.906	<b>Molecular Formula:</b> Cl <sub>2</sub>

#### Solvent Solubility

**Soluble:** alkali, chlorides, alcohols

### \*\*\* Section 10 - STABILITY AND REACTIVITY\*\*\*

#### Chemical Stability

Stable at normal temperatures and pressure.

#### Conditions to Avoid

Avoid contact with combustible materials. Minimize contact with material. Avoid inhalation of material or combustion by-products. Keep out of water supplies and sewers. May ignite or explode on contact with combustible materials.

#### Possibility of Hazardous Reactions

Will not polymerize.

#### Incompatible Materials

combustible materials, bases, metals, halogens, metal salts, reducing agents, amines, metal carbide, metal oxides, oxidizing materials, halo carbons, acids, arsenic, calcium, iodine, mercuric oxide, ethers, fluorine

#### Decomposition Products

chlorine

#### Hazardous Decomposition

**Water or Moisture:** hypochlorous acid, hydrochloric acid

### \*\*\* Section 11 - TOXICOLOGICAL INFORMATION\*\*\*

#### Acute and Chronic Toxicity

##### Component Analysis - LD50/LC50

The components of this material have been reviewed in various sources and the following selected endpoints are published:

**CHLORINE (7782-50-5)**

Inhalation LC50 Rat 293 ppm 1 h





## Safety Data Sheet

**Material Name:** CHLORINE

**SDS ID:** MAT04600

### RTECS Acute Toxicity (selected)

The components of this material have been reviewed, and RTECS publishes the following endpoints:

#### CHLORINE (7782-50-5)

**Inhalation:** 368 mg/m<sup>3</sup>/30 minute(s) Inhalation Mouse LC50; 137 ppm/1 hour Inhalation Mouse LC50  
293 ppm/1 hour Inhalation Rat LC50

### Acute Toxicity Level

#### CHLORINE (7782-50-5)

**Toxic:** inhalation

### Immediate Effects

respiratory tract burns, skin burns, eye burns, respiratory system effects, central nervous system effects

### Delayed Effects

respiratory tract burns, skin burns, eye burns, tooth erosion, kidney damage, respiratory system effects

### Irritation/Corrosivity Data

No animal testing data available for skin or eyes.

### RTECS Irritation

The components of this material have been reviewed and RTECS publishes no data as of the date on this document.

### Local Effects

#### CHLORINE (7782-50-5)

**Corrosive:** inhalation, skin, eye

### Respiratory Sensitizer

No data available.

### Dermal Sensitizer

No data available.

### Carcinogenicity

#### Component Carcinogenicity

#### CHLORINE (7782-50-5)

**ACGIH:** A4 - Not Classifiable as a Human Carcinogen

### RTECS Mutagenic

The components of this material have been reviewed, and RTECS publishes data for one or more components.

### RTECS Reproductive Effects

The components of this material have been reviewed, and RTECS publishes the following endpoints:

#### CHLORINE (7782-50-5)

565 mg/kg Oral Rat TDLo (8 week, prior to copulation 2 week, 3 week, continuous)

### RTECS Tumorigenic

The components of this material have been reviewed, and RTECS publishes data for one or more components.

### Specific Target Organ Toxicity - Single Exposure

respiratory system, central nervous system

### Specific Target Organ Toxicity - Repeated Exposure

teeth, kidneys, respiratory system

### Aspiration Hazard

Not applicable.

### Medical Conditions Aggravated by Exposure

heart problems



## Safety Data Sheet

Material Name: CHLORINE

SDS ID: MAT04600

### \*\*\* Section 12 - ECOLOGICAL INFORMATION\*\*\*

#### Component Analysis - Aquatic Toxicity

##### CHLORINE (7782-50-5)

**Fish:** 96 Hr LC50 Lepomis macrochirus: 0.44 mg/L [flow-through]; 96 Hr LC50 Oncorhynchus mykiss: 0.014 mg/L [flow-through]; 96 Hr LC50 Oncorhynchus mykiss: 0.014 mg/L; 96 Hr LC50 Oncorhynchus mykiss: 0.104 - 0.168 mg/L [static]; 96 Hr LC50 Pimephales promelas: 0.08 mg/L [flow-through]; 96 Hr LC50 Pimephales promelas: 0.1 mg/L

**Invertebrate:** 48 Hr LC50 Daphnia magna: 0.017 mg/L

#### Abiotic Degradation

Rapidly undergoes disproportionation in water to form hypochlorous acid and chloride ion.

#### Persistence and Degradability

No data available.

#### Bioaccumulative Potential

No data available.

#### Mobility in Environmental Media

No data available.

### \*\*\* Section 13 - DISPOSAL CONSIDERATIONS\*\*\*

#### Disposal Methods

Dispose in accordance with all applicable regulations. Subject to disposal regulations: U.S. EPA 40 CFR 262. Hazardous Waste Number(s): D001.

#### Component Waste Numbers

The U.S. EPA has not published waste numbers for this product's components.

### \*\*\* Section 14 - TRANSPORT INFORMATION\*\*\*

#### US DOT Information

**Shipping Name:** Chlorine  
**UN/NA #:** UN1017 **Hazard Class:** 2.3  
**Required Label(s):** 2.3, 5.1, 8  
**Additional Info.:** Toxic-Inhalation Hazard Zone B

#### IMDG Information

**Shipping Name:** Chlorine  
**UN #:** UN1017 **Hazard Class:** 2.3  
**Required Label(s):** 2.3, 5.1, 8



## Safety Data Sheet

**Material Name: CHLORINE**

**SDS ID: MAT04600**

### Component Marine Pollutants

This material contains one or more of the following chemicals required by US DOT to be identified as marine pollutants.

Component	CAS	
CHLORINE	7782-50-5	DOT regulated marine pollutant

### Component Marine Pollutants (IMDG)

This material contains one or more of the following chemicals required by IMDG to be identified as marine pollutants.

**CHLORINE (7782-50-5)**

IMDG regulated marine pollutant (UN1017)

**\*\*\* Section 15 - REGULATORY INFORMATION\*\*\***

### Component Analysis

#### U.S. Federal Regulations

This material contains one or more of the following chemicals required to be identified under SARA Section 302/304 (40 CFR 355 Appendix A), SARA Section 313 (40 CFR 372.65), CERCLA (40 CFR 302.4), TSCA 12(b), and/or require an OSHA process safety plan.

**CHLORINE (7782-50-5)**

- SARA 302:** 100 lb TPQ
- SARA 304:** 10 lb EPCRA RQ
- SARA 313:** 1.0 % de minimis concentration
- CERCLA:** 10 lb final RQ; 4.54 kg final RQ
- OSHA (safety):** 1500 lb TQ

#### SARA 311/312 Hazardous Categories

**Acute Health:** Yes **Chronic Health:** Yes **Fire:** Yes **Pressure:** Yes **Reactive:** No

#### U.S. State Regulations

The following components appear on one or more of the following state hazardous substances lists:

Component	CAS	CA	MA	MN	NJ	PA
CHLORINE	7782-50-5	Yes	Yes	Yes	Yes	Yes

Not regulated under California Proposition 65

#### Component Analysis - Inventory

Component	CAS	US	CA	EU	AU	PH	JP	KR	CN	NZ
CHLORINE	7782-50-5	Yes	DSL	EIN	Yes	Yes	No	Yes	Yes	Yes

**\*\*\* Section 16 - OTHER INFORMATION\*\*\***

**NFPA Ratings: Health:** 4 **Fire:** 0 **Reactivity:** 0 **Other:** Oxidizer

Hazard Scale: 0 = Minimal 1 = Slight 2 = Moderate 3 = Serious 4 = Severe



## Safety Data Sheet

Material Name: CHLORINE

SDS ID: MAT04600

### Key / Legend

ACGIH - American Conference of Governmental Industrial Hygienists; ADR - European Road Transport; AU - Australia; BOD - Biochemical Oxygen Demand; C - Celsius; CA - Canada; CAS - Chemical Abstracts Service; CERCLA - Comprehensive Environmental Response, Compensation, and Liability Act; CN - China; CPR - Controlled Products Regulations; DFG - Deutsche Forschungsgemeinschaft; DOT - Department of Transportation; DSL - Domestic Substances List; EEC - European Economic Community; EINECS - European Inventory of Existing Commercial Chemical Substances; EPA - Environmental Protection Agency; EU - European Union; F - Fahrenheit; IARC - International Agency for Research on Cancer; IATA - International Air Transport Association; ICAO - International Civil Aviation Organization; IDL - Ingredient Disclosure List; IDLH - Immediately Dangerous to Life and Health; IMDG - International Maritime Dangerous Goods; JP - Japan; Kow - Octanol/water partition coefficient; KR - Korea; LEL - Lower Explosive Limit; LOLI - List Of Lists™ - ChemADVISOR's Regulatory Database; MAK - Maximum Concentration Value in the Workplace; MEL - Maximum Exposure Limits; NFPA - National Fire Protection Agency; NIOSH - National Institute for Occupational Safety and Health; NJTSR - New Jersey Trade Secret Registry; NTP - National Toxicology Program; NZ - New Zealand; OSHA - Occupational Safety and Health Administration; PH - Philippines; RCRA - Resource Conservation and Recovery Act; RID - European Rail Transport; RTECS - Registry of Toxic Effects of Chemical Substances®; SARA - Superfund Amendments and Reauthorization Act; STEL - Short-term Exposure Limit; TDG - Transportation of Dangerous Goods; TSCA - Toxic Substances Control Act; TWA - Time Weighted Average; UEL - Upper Explosive Limit; US - United States

### Other Information

Matheson Tri-Gas, Inc. makes no express or implied warranties, guarantees or representations regarding the product or the information herein, including but not limited to any implied warranty or merchantability or fitness for use. Matheson Tri-Gas, Inc. shall not be liable for any personal injury, property or other damages of any nature, whether compensatory, consequential, exemplary, or otherwise, resulting from any publication, use or reliance upon the information herein.

End of Sheet MAT04600





## MATERIAL SAFETY DATA SHEET

### 1. Product and Company Identification

**Material name** NITRIC ACID  
**Version #** 09  
**Revision date** 09-27-2011  
**CAS #** Mixture  
**Product Codes** J.T.Baker: 5371, 5796, 5801, 5856, 5876, 9597, 9598, 9601, 9602, 9606, 9607, 9610, 9612, 9615, 9616, 9618, 9670, 9761  
 Macron: 1409, 20750, 20752, 20754, 2704, 2705, 2706, 2707, 2712, 6623, H988, IM9612, V007, V077, V228, V230, V231, V471, V647  
**Synonym(s)** AQUA FORTIS \* AZOTIC ACID  
**Manufacturer** Avantor Performance Materials, Inc.  
**Address** 3477 Corporate Parkway  
 Suite #200  
 Center Valley, PA 18034  
 US  
**Customer Service** 855-282-6867  
**24 Hour Emergency** 908-859-2151  
**Chemtrec** 800-424-9300

### 2. Hazards Identification

**Emergency overview** DANGER -- OXIDIZER  
 Oxidizing material. Contact with combustible material may cause fire.  
 Corrosive. Causes severe skin and eye burns. Causes digestive tract burns. Mist or vapor extremely irritating to eyes and respiratory tract.

**OSHA regulatory status** This product is considered hazardous under 29 CFR 1910.1200 (Hazard Communication).

**Potential health effects**  
**Routes of exposure** Ingestion. Inhalation. Skin contact. Eye contact.  
**Eyes** Corrosive. Causes severe eye burns. Vapor or spray may cause eye damage, impaired sight or blindness.  
**Skin** Corrosive. Causes severe skin burns.  
**Inhalation** Corrosive. May cause damage to mucous membranes in nose, throat, lungs and bronchial system.  
**Ingestion** Corrosive. Ingestion may produce burns to the lips, oral cavity, upper airway, esophagus and possibly the digestive tract.

**Target organs** Eyes. Skin. Lungs. Respiratory system.  
**Chronic effects** Corrosive. Prolonged contact causes serious tissue damage.  
**Potential environmental effects** The product may affect the acidity (pH-factor) in water with risk of harmful effects to aquatic organisms.

### 3. Composition / Information on Ingredients

Hazardous components	CAS #	Percent
NITRIC ACID	7697-37-2	65 - 70
Non-hazardous components	CAS #	Percent
WATER	7732-18-5	30 - 35



#### 4. First Aid Measures

##### First aid procedures

- Eye contact** Immediately flush with plenty of water for at least 15 minutes. If easy to do, remove contact lenses. Call a physician or poison control center immediately. In case of irritation from airborne exposure, move to fresh air. Get medical attention immediately.
- Skin contact** Immediately flush with plenty of water for at least 15 minutes while removing contaminated clothing and shoes. Call a physician or poison control center immediately. Wash clothing separately before reuse. Destroy or thoroughly clean contaminated shoes.
- Inhalation** Move to fresh air. If breathing stops, provide artificial respiration. If breathing is difficult, give oxygen. Call a physician or poison control center immediately.
- Ingestion** Call a physician or poison control center immediately. Do not induce vomiting. If vomiting occurs, the head should be kept low so that stomach vomit doesn't enter the lungs.

##### Notes to physician

Keep victim under observation. Treat symptomatically.

##### General advice

In the case of accident or if you feel unwell, seek medical advice immediately (show the label where possible). Show this safety data sheet to the doctor in attendance. Ensure that medical personnel are aware of the material(s) involved, and take precautions to protect themselves.

#### 5. Fire Fighting Measures

##### Flammable properties

This product is not flammable.

##### Extinguishing media

**Suitable extinguishing media** Water. Carbon dioxide (CO<sub>2</sub>). Dry chemical powder. Foam.

**Unsuitable extinguishing media** None known.

##### Protection of firefighters

**Specific hazards arising from the chemical** OXIDIZING! Contact with combustible material may cause fire. These substances will accelerate burning when involved in a fire. Some will react explosively with hydrocarbons (fuels). Some may decompose explosively when heated or involved in a fire. Runoff may create fire or explosion hazard. Fire may produce irritating, corrosive and/or toxic gases.

**Protective equipment and precautions for firefighters** Use water spray to cool unopened containers. Self-contained breathing apparatus and full protective clothing must be worn in case of fire. Cool containers exposed to flames with water until well after the fire is out.

##### Special protective equipment for fire-fighters

Wear full protective clothing, including helmet, self-contained positive pressure or pressure demand breathing apparatus, protective clothing and face mask. Wear self-contained breathing apparatus with a full facepiece operated in the positive pressure demand mode when fighting fires.

##### Specific methods

In the event of fire and/or explosion do not breathe fumes.

#### 6. Accidental Release Measures

##### Personal precautions

Eliminate all sources of ignition. Wear appropriate protective equipment and clothing during clean-up. Keep upwind. Keep out of low areas. Ventilate closed spaces before entering them. Local authorities should be advised if significant spillages cannot be contained.

##### Environmental precautions

Prevent further leakage or spillage if safe to do so. Avoid discharge into drains, water courses or onto the ground.

##### Methods for containment

Stop the flow of material, if this is without risk. Keep combustibles (wood, paper, oil, etc.) away from spilled material. Dike the spilled material, where this is possible. Prevent entry into waterways, sewer, basements or confined areas.





**Methods for cleaning up**

Keep combustibles (wood, paper, oil, etc.) away from spilled material.

Large Spills: Dike far ahead of spill for later disposal. Use a non-combustible material like vermiculite, sand or earth to soak up the product and place into a container for later disposal.

Small Spills: Absorb spillage with non-combustible, absorbent material. Collect in a non-combustible container for prompt disposal. Clean surface thoroughly to remove residual contamination.

Never return spills in original containers for re-use. Clean up in accordance with all applicable regulations. Neutralize spill area and washings with soda ash or lime. Collect in a non-combustible container for prompt disposal.

J. T. Baker NEUTRASORB® acid neutralizers are recommended for spills of this product.

**7. Handling and Storage**

**Handling**

Keep away from clothing and other combustible materials. Do not get in eyes, on skin, on clothing. Do not taste or swallow. Wash thoroughly after handling. Do not eat, drink or smoke when using the product. Use caution when combining with water; DO NOT add water to acid, ALWAYS add acid to water while stirring to prevent release of heat, steam and fumes.

**Storage**

Do not store in metal containers. Keep away from heat and sources of ignition. Do not store near combustible materials. Keep tightly closed in a dry, cool and well-ventilated place.

**8. Exposure Controls / Personal Protection**

**ACGIH**

**Components**

**Type**

**Value**

NITRIC ACID (7697-37-2)

STEL

4.0000 ppm

TWA

2.0000 ppm

**Occupational exposure limits**

**U.S. - OSHA**

**Components**

**Type**

**Value**

NITRIC ACID (7697-37-2)

PEL

2.0000 ppm

5.0000 mg/m3

**Engineering controls**

Good general ventilation (typically 10 air changes per hour) should be used. Ventilation rates should be matched to conditions. If applicable, use process enclosures, local exhaust ventilation, or other engineering controls to maintain airborne levels below recommended exposure limits. If exposure limits have not been established, maintain airborne levels to an acceptable level.

**Personal protective equipment**

**Eye / face protection**

Wear safety glasses with side shields (or goggles) and a face shield.

**Skin protection**

Wear appropriate chemical resistant clothing. Wear appropriate chemical resistant gloves.

**Respiratory protection**

If engineering controls do not maintain airborne concentrations below recommended exposure limits (where applicable) or to an acceptable level (in countries where exposure limits have not been established), an approved respirator must be worn. Respirator type: Chemical respirator with acid gas cartridge.

**General hygiene considerations**

Provide eyewash station and safety shower. Keep from contact with clothing and other combustible materials. Remove and wash contaminated clothing promptly. Always observe good personal hygiene measures, such as washing after handling the material and before eating, drinking, and/or smoking. Routinely wash work clothing and protective equipment to remove contaminants.

**General**

Wear chemical protective equipment that is specifically recommended by the manufacturer. Launder contaminated clothing before reuse.



## 9. Physical & Chemical Properties

Appearance	Clear.
Color	Colorless to light yellow.
Odor	Pungent.
Odor threshold	Not available.
Physical state	Liquid.
Form	Liquid.
pH	1 (0.1 M Solution)
Melting point	-43.6 °F (-42 °C)
Freezing point	-43.6 °F (-42 °C)
Boiling point	251.6 °F (122 °C)
Flash point	Not available.
Evaporation rate	Not available.
Flammability limits in air, upper, % by volume	Not available.
Flammability limits in air, lower, % by volume	Not available.
Vapor pressure	6.4 kPa
Vapor density	2 - 3
Specific gravity	1.41
Relative density	Not available.
Solubility (water)	Not available.
Partition coefficient (n-octanol/water)	Not available
Auto-ignition temperature	Not available.
Decomposition temperature	Not available.

## 10. Chemical Stability & Reactivity Information

Chemical stability	Decomposes on heating. Material is stable under normal conditions.
Conditions to avoid	Reacts violently with strong alkaline substances. This product may react with reducing agents. Do not mix with other chemicals. Avoid heat. Exposure to light.
Incompatible materials	Incompatible with bases. Alcohols. Combustible material. This product may react with reducing agents. May be corrosive to metals. On contact with water an exothermic reaction may occur emitting steam, heat and toxic fumes.
Hazardous decomposition products	Nitrogen oxides (NOx). May decompose upon heating to produce corrosive and/or toxic fumes.
Possibility of hazardous reactions	Hazardous polymerization does not occur.

## 11. Toxicological Information

Toxicological data	
Product	Test Results
NITRIC ACID (Mixture)	Acute Inhalation LC50 Rat: 96.3 mg/l estimated
Components	Test Results
NITRIC ACID (7697-37-2)	Acute Inhalation LC50 Rat: 65 mg/l 4.00 Hours
Sensitization	Not a skin sensitizer.
Acute effects	Strongly corrosive. May cause deep tissue damage. Vapors are corrosive. After some hours, injured persons may develop serious shortness of breath and lung edema.



<b>Local effects</b>	Causes severe burns.
<b>Chronic effects</b>	Corrosive. Prolonged contact causes serious tissue damage.
<b>Carcinogenicity</b>	This product is not considered to be a carcinogen by IARC, ACGIH, NTP, or OSHA.
<b>Skin corrosion/irritation</b>	Corrosive to skin and eyes.
<b>Epidemiology</b>	No epidemiological data is available for this product.
<b>Mutagenicity</b>	No data available to indicate product or any components present at greater than 0.1% are mutagenic or genotoxic.
<b>Neurological effects</b>	No data available for this product.
<b>Reproductive effects</b>	Contains no ingredient listed as toxic to reproduction
<b>Teratogenicity</b>	No data available to indicate product or any components present at greater than 0.1% may cause birth defects.
<b>Symptoms and target organs</b>	Corrosive effects.
<b>Further information</b>	Danger of very serious irreversible effects. Symptoms may be delayed.

## 12. Ecological Information

<b>Ecotoxicity</b>	The product may affect the acidity (pH-factor) in water with risk of harmful effects to aquatic organisms.
<b>Persistence and degradability</b>	Expected to be readily biodegradable.
<b>Partition coefficient (n-octanol/water)</b>	Not available

## 13. Disposal Considerations

<b>Waste codes</b>	D002: Waste Corrosive material [pH <=2 or =>12.5, or corrosive to steel]
<b>Disposal instructions</b>	Dispose of this material and its container to hazardous or special waste collection point. Incinerate the material under controlled conditions in an approved incinerator. All wastes must be handled in accordance with local, state and federal regulations.
<b>Contaminated packaging</b>	Since emptied containers retain product residue, follow label warnings even after container is emptied. Offer rinsed packaging material to local recycling facilities.

## 14. Transport Information

### DOT

#### Basic shipping requirements:

<b>UN number</b>	UN2031
<b>Proper shipping name</b>	Nitric acid
<b>Hazard class</b>	8
<b>Subsidiary hazard class</b>	5.1
<b>Packing group</b>	II

#### Additional information:

<b>Special provisions</b>	A6, B2, B47, B53, IB2, T8, TP2, TP12
<b>Packaging exceptions</b>	None
<b>Packaging non bulk</b>	158
<b>Packaging bulk</b>	242
<b>ERG number</b>	157

### IATA

#### Basic shipping requirements:

<b>UN number</b>	2031
<b>Proper shipping name</b>	Nitric acid
<b>Hazard class</b>	8
<b>Subsidiary hazard class</b>	5.1
<b>Packing group</b>	II



**Additional information:**

ERG code 8L

**IMDG**

**Basic shipping requirements:**

UN number 2031  
Proper shipping name NITRIC ACID  
Hazard class 8  
Subsidiary hazard class 5.1  
Packing group II



DOT



IATA



IMDG

**15. Regulatory Information**

**US federal regulations** This product is a "Hazardous Chemical" as defined by the OSHA Hazard Communication Standard, 29 CFR 1910.1200.  
All components are on the U.S. EPA TSCA Inventory List.

**US EPCRA (SARA Title III) Section 302 - Extremely Hazardous Spill: Reportable quantity**

NITRIC ACID (CAS 7697-37-2) 1000 LBS

**US EPCRA (SARA Title III) Section 302 - Extremely Hazardous Substance: Threshold Planning Quantity**

NITRIC ACID (CAS 7697-37-2) 1000 LBS

**US EPCRA (SARA Title III) Section 313 - Toxic Chemical: De minimis concentration**

NITRIC ACID (CAS 7697-37-2) 1.0 %

**US EPCRA (SARA Title III) Section 313 - Toxic Chemical: Listed substance**

NITRIC ACID (CAS 7697-37-2) Listed.

**CERCLA (Superfund) reportable quantity**

NITRIC ACID: 1000.0000

**Superfund Amendments and Reauthorization Act of 1986 (SARA)**

**Hazard categories**  
Immediate Hazard - Yes  
Delayed Hazard - Yes  
Fire Hazard - Yes  
Pressure Hazard - No  
Reactivity Hazard - No

**Section 311 hazardous chemical** Yes

**Inventory status**

Country(s) or region	Inventory name	On inventory (yes/no)*
Australia	Australian Inventory of Chemical Substances (AICS)	Yes
Canada	Domestic Substances List (DSL)	Yes
Canada	Non-Domestic Substances List (NDSL)	No
China	Inventory of Existing Chemical Substances in China (IECSC)	Yes
Europe	European Inventory of Existing Commercial Chemical Substances (EINECS)	Yes
Europe	European List of Notified Chemical Substances (ELINCS)	No
Japan	Inventory of Existing and New Chemical Substances (ENCS)	Yes





Country(s) or region	Inventory name	On inventory (yes/no)*
Korea	Existing Chemicals List (ECL)	Yes
New Zealand	New Zealand Inventory	Yes
Philippines	Philippine Inventory of Chemicals and Chemical Substances (PICCS)	Yes
United States & Puerto Rico	Toxic Substances Control Act (TSCA) Inventory	Yes
*A "Yes" indicates that all components of this product comply with the inventory requirements administered by the governing country(s)		
<b>State regulations</b>	This product does not contain a chemical known to the State of California to cause cancer, birth defects or other reproductive harm.	
<b>US - New Jersey Community RTK (EHS Survey): Reportable threshold</b>		
	NITRIC ACID (CAS 7697-37-2)	500 LBS
<b>US - Pennsylvania RTK - Hazardous Substances: Listed substance</b>		
	NITRIC ACID (CAS 7697-37-2)	Listed.
<b>Saf-T-Data</b>	Health: 3 - Severe (Poison) Flammability: 0 - None Reactivity: 3 - Severe (Oxidizer) Contact: 4 - Extreme (Corrosive) Lab Protective Equip: D - GOGGLES & SHIELD; LAB COAT & APRON; VENT HOOD; PROPER GLOVES Storage Color Code: W - White (Corrosive)	
<b>16. Labeling Info</b>		
<b>Label Hazard Warning</b>	DANGER -- OXIDIZER Contact with combustible material may cause fire. Corrosive. Causes severe skin and eye burns. Causes digestive tract burns. Mist or vapor extremely irritating to eyes and respiratory tract.	
<b>Label Precautions</b>	Do not breathe mist or vapor. Do not get in eyes, on skin, or on clothing. Use only with adequate ventilation. Wash thoroughly after handling. Keep container closed. Keep from contact with clothing and other combustible materials. Remove and wash contaminated clothing promptly.	
<b>Label First Aid</b>	Immediately flush eyes with plenty of water for at least 15 minutes. Immediately flush skin with plenty of water. If gas/fume/vapor/dust/mist from the material is inhaled, remove the affected person immediately to fresh air. Get medical attention immediately. IF SWALLOWED: Immediately call a POISON CENTER or doctor/physician. Do not induce vomiting without advice from poison control center. If vomiting occurs, keep head low so that stomach content doesn't get into the lungs. Do not use mouth-to-mouth method if victim ingested the substance.	
<b>17. Other Information</b>		
<b>NFPA ratings</b>	Health: 3 Flammability: 0 Instability: 1 Special hazards: OX	
Material name: NITRIC ACID		MSDS US COV
MSDS ID: N3660 Version #: 09 Revision date: 09-27-2011		7 / 8



**Disclaimer**

THE INFORMATION PRESENTED IN THIS MATERIAL SAFETY DATA SHEET (MSDS/SDS) WAS PREPARED BY TECHNICAL PERSONNEL BASED ON DATA THAT THEY BELIEVE IN THEIR GOOD FAITH JUDGMENT IS ACCURATE. HOWEVER, THE INFORMATION PROVIDED HEREIN IS PROVIDED "AS IS," AND AVANTOR PERFORMANCE MATERIALS MAKES AND GIVES NO REPRESENTATIONS OR WARRANTIES WHATSOEVER, AND EXPRESSLY DISCLAIMS ALL WARRANTIES REGARDING SUCH INFORMATION AND THE PRODUCT TO WHICH IT RELATES, WHETHER EXPRESS, IMPLIED, OR STATUTORY, INCLUDING WITHOUT LIMITATION, WARRANTIES OF ACCURACY, COMPLETENESS, MERCHANTABILITY, NON-INFRINGEMENT, PERFORMANCE, SAFETY, SUITABILITY, STABILITY, AND FITNESS FOR A PARTICULAR PURPOSE, AND ANY WARRANTIES ARISING FROM COURSE OF DEALING, COURSE OF PERFORMANCE, OR USAGE OF TRADE. THIS MSDS/SDS IS INTENDED ONLY AS A GUIDE TO THE APPROPRIATE PRECAUTIONARY HANDLING OF THE MATERIAL BY A PROPERLY TRAINED PERSON USING THIS PRODUCT, AND IS NOT INTENDED TO BE COMPREHENSIVE AS TO THE MANNER AND CONDITIONS OF USE, HANDLING, STORAGE, OR DISPOSAL OF THE PRODUCT. INDIVIDUALS RECEIVING THIS MSDS/SDS MUST ALWAYS EXERCISE THEIR OWN INDEPENDENT JUDGMENT IN DETERMINING THE APPROPRIATENESS OF SUCH ISSUES. ACCORDINGLY, AVANTOR PERFORMANCE MATERIALS ASSUMES NO LIABILITY WHATSOEVER FOR THE USE OF OR RELIANCE UPON THIS INFORMATION. NO SUGGESTIONS FOR USE ARE INTENDED AS, AND NOTHING HEREIN SHALL BE CONSTRUED AS, A RECOMMENDATION TO INFRINGE ANY EXISTING PATENTS OR TO VIOLATE ANY FEDERAL, STATE, LOCAL, OR FOREIGN LAWS. AVANTOR PERFORMANCE MATERIALS REMINDS YOU THAT IT IS YOUR LEGAL DUTY TO MAKE ALL INFORMATION IN THIS MSDS/SDS AVAILABLE TO YOUR EMPLOYEES.

**Issue date**

09-27-2011





# Safety Data Sheet

## 1. IDENTIFICATION OF THE MATERIAL AND SUPPLIER

**Product Name:** **AMMONIA - ANHYDROUS**

**Other name(s):** Ammonia anhydrous; Ammonia gas; Anhydrous ammonia; Ammonia liquid; Big N; Ammonia cylinder (used).

**Recommended use of the chemical and restrictions on use:** Fertilizer; preparation of fertilizers; chemical synthesis; condensation catalyst; latex preservative; manufacture of explosives; rocket fuel.

**Supplier:** Orica Australia Pty Ltd  
**ABN:** 99 004 117 828  
**Street Address:** 1 Nicholson Street, Melbourne 3000 Australia

**Telephone Number:** +61 3 9665 7111  
**Facsimile:** +61 3 9665 7937  
**Emergency Telephone:** **1 800 033 111 (ALL HOURS)**

## 2. HAZARDS IDENTIFICATION

Classified as Dangerous Goods by the criteria of the Australian Dangerous Goods Code (ADG Code) for Transport by Road and Rail; DANGEROUS GOODS.

This material is hazardous according to Safe Work Australia; HAZARDOUS SUBSTANCE.

**Classification of the substance or mixture:**

Flammable Gases - Category 2  
Gases under pressure - Liquefied Gas  
Acute Inhalation Toxicity - Category 3  
Skin Corrosion - Sub-category 1B  
Eye Damage - Category 1  
Specific target organ toxicity (single exposure) - Category 3  
Acute Aquatic Toxicity - Category 1

**SIGNAL WORD:** POISON



**Hazard Statement(s):**

H221 Flammable gas.  
H280 Contains gas under pressure; may explode if heated.  
H314 Causes severe skin burns and eye damage.  
H331 Toxic if inhaled.  
H335 May cause respiratory irritation.  
H400 Very toxic to aquatic life.

**Product Name:** AMMONIA - ANHYDROUS  
**Substance No:** 000031098301

**Issued:** 01/03/2013  
**Version:** 4



# Safety Data Sheet

## Precautionary Statement(s):

### Prevention:

- P210 Keep away from heat / sparks / open flames / hot surfaces. No smoking.
- P260 Do not breathe dust / fume / gas / mist / vapours / spray.
- P264 Wash hands thoroughly after handling.
- P271 Use only outdoors or in a well-ventilated area.
- P273 Avoid release to the environment.
- P280 Wear protective gloves / protective clothing / eye protection / face protection.

### Response:

- P301+P330+P331 IF SWALLOWED: Rinse mouth. Do NOT induce vomiting.
- P303+P361+P353 IF ON SKIN (or hair): Take off immediately all contaminated clothing. Rinse skin with water/shower.
- P321 Specific treatment (see First Aid Measures on Safety Data Sheet).
- P363 Wash contaminated clothing before re-use.
- P304+P340 IF INHALED: Remove person to fresh air and keep comfortable for breathing.
- P311 Call a POISON CENTER or doctor/physician.
- P305+P351+P338 IF IN EYES: Rinse cautiously with water for several minutes. Remove contact lenses, if present and easy to do. Continue rinsing.
- P310 Immediately call a POISON CENTER or doctor/physician.
- P377 Leaking gas fire: Do not extinguish, unless leak can be stopped safely.
- P381 Eliminate all ignition sources if safe to do so.
- P391 Collect spillage.

### Storage:

- P403+P233 Store in a well-ventilated place. Keep container tightly closed.
- P405 Store locked up.
- P410 Protect from sunlight.

### Disposal:

- P501 Dispose of contents/container in accordance with local/regional/national/international regulations.

**Poisons Schedule (SUSMP):** S6 Poison.

## 3. COMPOSITION/INFORMATION ON INGREDIENTS

Components	CAS Number	Proportion	Hazard Codes
Ammonia	7664-41-7	99-100%	H221 H331 H314 H400
Water	7732-18-5	0-1%	-

## 4. FIRST AID MEASURES

For advice, contact a Poisons Information Centre (e.g. phone Australia 131 126; New Zealand 0800 764 766) or a doctor. Urgent hospital treatment is likely to be needed.

### Inhalation:

Remove victim from area of exposure - avoid becoming a casualty. Remove contaminated clothing and loosen remaining clothing. Allow patient to assume most comfortable position and keep warm. Keep at rest until fully recovered. If patient finds breathing difficult and develops a bluish discoloration of the skin (which suggests a lack of oxygen in the blood - cyanosis), ensure airways are clear of any obstruction and have a qualified person give oxygen through a face mask. Apply artificial respiration if patient is not breathing. Seek immediate medical advice.

### Skin Contact:

If spilt on large areas of skin or hair, immediately drench with running water and remove clothing. Continue to wash skin and hair with plenty of water (and soap if material is insoluble) until advised to stop by the Poisons Information Centre or a doctor. For freeze burns, immediately flood burnt area with large amounts of luke-warm water and cover with a clean, dry dressing. Do not use hot water. Seek immediate medical assistance.

**Product Name: AMMONIA - ANHYDROUS**  
**Substance No: 000031098301**

**Issued: 01/03/2013**  
**Version: 4**



## Safety Data Sheet

### Eye Contact:

Immediately wash in and around the eye area with large amounts of water for at least 15 minutes. Eyelids to be held apart. Remove clothing if contaminated and wash skin. Urgently seek medical assistance. Transport to hospital or medical centre.

### Ingestion:

Immediately rinse mouth with water. If swallowed, do NOT induce vomiting. Give a glass of water. Get to a doctor or hospital quickly.

### Indication of immediate medical attention and special treatment needed:

Treat symptomatically. Delayed pulmonary oedema may result. Following severe exposure, the patient should be kept under medical supervision for at least 48 hours.

Can cause corneal burns.

## 5. FIRE FIGHTING MEASURES

### Suitable Extinguishing Media:

Fine water spray, normal foam, dry agent (carbon dioxide, dry chemical powder). Water spray can be used to bring down the vapour but should not be sprayed on pools of liquid ammonia. If water is used, a minimum of 100 volumes of water must be available for each volume of ammonia.

### Hazchem or Emergency Action Code: 2RE

### Specific hazards arising from the substance or mixture:

Combustible gas. May form flammable vapour mixtures with air. Avoid all ignition sources. All potential sources of ignition (open flames, pilot lights, furnaces, spark producing switches and electrical equipment etc) must be eliminated both in and near the work area. Do NOT smoke. Flammable concentrations of ammonia gas can accumulate in the vapour space of storage containers/vessels. Caution should be exercised when opening.

### Special protective equipment and precautions for fire-fighters:

Ammonia: The main products of combustion in air, at or above 780 °C, are nitrogen and water with small amounts of nitrogen dioxide and ammonium nitrate. Ammonia decomposes into flammable hydrogen gas at approximately 450 °C. May form flammable mixtures in air. The presence of oil or other combustible material will increase the fire hazard. Fatalities have occurred as a result of the explosive nature of the ammonia gas. If involved in a fire, keep containers cool with water spray. If safe to do so, remove containers from path of fire. Fire-fighters to wear full body protective clothing and self-contained breathing apparatus. Consider evacuation.

## 6. ACCIDENTAL RELEASE MEASURES

### Emergency procedures/Environmental precautions:

Shut off all possible sources of ignition. Clear area of all unprotected personnel. If contamination of sewers or waterways has occurred advise emergency services or State Department of Agriculture.

### Personal precautions/Protective equipment/Methods and materials for containment and cleaning up:

Avoid breathing in vapours. Work up wind or increase ventilation. Wear protective equipment to prevent skin and eye contamination and the inhalation of vapours. Stop leak if safe to do so.

### Additional information:

GAS: For a small gas leak, increase ventilation and allow gas to vent to a safe area. For larger gas leaks, use fire hoses equipped with fog nozzles to disperse gas down-wind. Do NOT spray water directly on the leak or ammonia container.

LIQUID: Large volumes of gas will evaporate from a liquid spill. For small liquid spills, increase ventilation and allow the liquid to volatilise to safe area. For large spills, cover liquid with protein foam 150 mm thick. DO NOT HOSE LIQUID AMMONIA TO DRAIN; contact with water will accelerate vapourisation due to liberation of heat upon mixing with water.

## 7. HANDLING AND STORAGE

Product Name: AMMONIA - ANHYDROUS  
Substance No: 000031098301

Issued: 01/03/2013  
Version: 4





## Safety Data Sheet

### 7. HANDLING AND STORAGE

**Precautions for safe handling:**

Avoid skin and eye contact and breathing in vapour. Keep out of reach of children.

**Conditions for safe storage, including any incompatibilities:**

Store ammonia in a cool, well ventilated area, away from sources of heat or ignition and foodstuffs. Store away from oxidising agents, boron halides, acids, acid anhydrides, acid chlorides, halogens (eg. chlorine), interhalogens, heavy metals and their salts, ethylene oxide, hypochlorous acid and acetaldehyde. Check cylinders regularly for leaks.

The transport of liquefied ammonia in a tank or bulk container made of quenched and tempered steel is prohibited unless the liquefied ammonia contains not less than 0.2% water mass. May be an explosion hazard, especially in confined spaces. Ensure pressure gauges and fittings are not made of copper, zinc or alloys (eg. brass).

Refer to AS/NZS 2022:2003 Anhydrous ammonia - Storage and handling.

### 8. EXPOSURE CONTROLS/PERSONAL PROTECTION

Ammonia: 8hr TWA = 17 mg/m<sup>3</sup> (25 ppm), 15 min STEL = 24 mg/m<sup>3</sup> (35 ppm)

As published by Safe Work Australia Workplace Exposure Standards for Airborne Contaminants.

TWA - The time-weighted average airborne concentration of a particular substance when calculated over an eight-hour working day, for a five-day working week.

STEL (Short Term Exposure Limit) - the airborne concentration of a particular substance calculated as a time-weighted average over 15 minutes, which should not be exceeded at any time during a normal eight hour work day. According to current knowledge this concentration should neither impair the health of, nor cause undue discomfort to, nearly all workers.

These Workplace Exposure Standards are guides to be used in the control of occupational health hazards. All atmospheric contamination should be kept to as low a level as is workable. These workplace exposure standards should not be used as fine dividing lines between safe and dangerous concentrations of chemicals. They are not a measure of relative toxicity.

**Appropriate engineering controls:**

Ensure ventilation is adequate to maintain air concentrations below Workplace Exposure Standards. Use with local exhaust ventilation or while wearing air supplied mask. Ammonia gas is generally lighter than air and will disperse under normal conditions. However, when ammonia liquid contacts air, the gas produced may be heavier than air. Prevent concentration in hollows or sumps. Do NOT enter confined spaces where vapour may have collected. An asphyxiant gas which can lead to the reduction of the oxygen concentration by displacement or dilution. The minimum oxygen content in air should be 18% by volume under normal atmospheric pressure.

**Individual protection measures, such as Personal Protective Equipment (PPE):**

The selection of PPE is dependant on a detailed risk assessment. The risk assessment should consider the work situation, the physical form of the chemical, the handling methods, and environmental factors.

Orica Personal Protection Guide No. 1, 1998: J - OVERALLS, CHEMICAL GOGGLES, RUBBER BOOTS, AIR MASK , GLOVES (Long), APRON.

\* Not required if wearing air supplied mask.



Product Name: AMMONIA - ANHYDROUS  
Substance No: 000031098301

Issued: 01/03/2013  
Version: 4



## Safety Data Sheet

**GENERAL:** Avoid all contact. Ensure safety shower and eyewash station is close at hand. Persons who could be subject to ammonia exposure must not wear contact lenses. Always wash hands before smoking, eating, drinking or using the toilet. Wash contaminated clothing and other protective equipment before storage or re-use.

**EYE PROTECTION:** Wear gas tight goggles which have a seal between the face and the frame. A full face shield shall only be worn to supplement the protection provided by the gas tight goggles.

**SKIN PROTECTION:** Wear coveralls, or full length trousers with a long sleeved shirt, with gloves and boots. Available information suggests that gloves made from chlorobutyl-proofed fabric or butyl rubber should be suitable for intermittent contact. However, due to variations in glove construction and local conditions, a final assessment should be made by the user. A complete encapsulating suit is recommended for heavy exposures.

**RESPIRATORY PROTECTION:** Use with adequate ventilation. Up to 250 ppm - wear vapour respirator with type K cartridge or air supplied mask meeting the requirements of AS/NZS 1715 and AS/NZS 1716. Greater than 250 ppm - wear air supplied full face mask meeting the requirements of AS/NZS 1715 and AS/NZS 1716.

### 9. PHYSICAL AND CHEMICAL PROPERTIES

<b>Physical state:</b>	Gas . Liquid under pressure.
<b>Colour:</b>	Colourless
<b>Odour:</b>	Intensely irritating ammoniacal odour.
<b>Odour Threshold:</b>	5-53 ppm.
<b>Molecular Formula:</b>	NH <sub>3</sub>
<b>Solubility:</b>	Soluble in water. Soluble in alcohol and ether.
<b>Specific Gravity:</b>	0.68 (-33 °C)
<b>Relative Vapour Density (air=1):</b>	0.6
<b>Vapour Pressure (20 °C):</b>	882 kPa
<b>Flash Point (°C):</b>	Not available
<b>Flammability Limits (%):</b>	15.5 - 25
<b>Autoignition Temperature (°C):</b>	651
<b>% Volatile by Volume:</b>	100
<b>Boiling Point/Range (°C):</b>	-33.4
<b>pH:</b>	ca. 11.7 (1% aqueous solution)
<b>Viscosity:</b>	0.266 cP @-34°C
<b>Freezing Point/Range (°C):</b>	-34.9 (20% solution)

### 10. STABILITY AND REACTIVITY

<b>Reactivity:</b>	Reacts violently with acids.
<b>Chemical stability:</b>	Stable under normal ambient and anticipated storage and handling conditions of temperature and pressure. Ammonia dissolves exothermically in water. Can react explosively with chlorine and hypochlorites or other strong oxidising agents. Critical pressure = 11.4 MPa.
<b>Possibility of hazardous reactions:</b>	Corrosive to copper , zinc , and their alloys .
<b>Conditions to avoid:</b>	Avoid exposure to heat, sources of ignition, and open flame.
<b>Incompatible materials:</b>	Incompatible with oxidising agents , boron halides , acids , acid anhydrides , acid chlorides , halogens , interhalogens , heavy metals and their salts , ethylene oxide , hypochlorous acid , calcium , acetaldehyde .
<b>Hazardous decomposition products:</b>	Hydrogen. Oxides of nitrogen.

**Product Name: AMMONIA - ANHYDROUS**  
**Substance No: 000031098301**

**Issued: 01/03/2013**  
**Version: 4**



## Safety Data Sheet

### 11. TOXICOLOGICAL INFORMATION

No adverse health effects expected if the product is handled in accordance with this Safety Data Sheet and the product label. Symptoms or effects that may arise if the product is mishandled and overexposure occurs are:

- Ingestion:** Not a likely route of exposure, however, swallowing liquid will result in freeze burns of the mouth, throat and stomach.
- Eye contact:** A severe eye irritant. Corrosive to eyes; contact can cause corneal burns. Contamination of eyes can result in permanent injury. Liquid splashes or spray may cause freeze burns to the eye.
- Skin contact:** Liquid splashes or spray may cause freeze burns. Contact with skin will result in severe irritation. Corrosive to skin - may cause skin burns.
- Inhalation:** Material is irritant to the mucous membranes of the respiratory tract (airways). Exposure to concentrations above the Exposure Standard of 25 ppm may cause irritation to the eyes, nose and throat. Higher concentrations may cause breathing difficulty, chest pain, bronchospasm, pink frothy sputum and pulmonary oedema. This may further predispose the patient to the development of acute bronchitis and pneumonia. Overexposure may result in death.

**Acute toxicity:**

Oral LD50 (rat): 350 mg/kg  
Inhalation LC50 (rat): 2000 ppm/4hr

**Skin corrosion/irritation:** Irritant (human).

**Serious eye damage/irritation:** Severe irritant (human).

**Chronic effects:** Chronic exposure to ammonia may cause chemical pneumonitis and kidney damage.

Ammonia: Lowest Published Lethal Concentration (human) = 5,000 ppm/5 min.

Irritation of the respiratory tract and conjunctivae was found in workers inhaling 100 ppm ammonia and 20 ppm caused complaints and discomfort to unacclimatized workers.

Studies on the effect on man of exposures in the 5-50 ppm range are few, however general field experience in a large number of workers exposed to ammonia from blueprinting and copying machines indicates a maximum acceptable concentration without severe complaints of 20-25 ppm.

### 12. ECOLOGICAL INFORMATION

- Ecotoxicity** Avoid contaminating waterways.
- Persistence/degradability:** Ammonia is strongly adsorbed to soil and sediment particles and colloids in water.
- Aquatic toxicity:** Very toxic to aquatic organisms. Ammonia is readily oxidised to nitrite which is also very toxic to fish.  
24hr LC50 (rainbow trout - fertilized egg) = >3.58 mg/L.  
24hr LC50 (rainbow trout - alevins 0-50 days old) = >3.58 mg/L.  
24hr LC50 (rainbow trout - fry 85 days old) = 0.068 mg/L.  
24hr LC50 (rainbow trout - adult): 0.097 mg/L.
- 48hr LC50 (Daphnia magna): 24 - 189 mg/L.  
96hr LC50 (rainbow trout): 0.53 mg/L.
- Terrestrial toxicity:** Expected to be harmful to terrestrial species.

**Product Name:** AMMONIA - ANHYDROUS  
**Substance No:** 000031098301

**Issued:** 01/03/2013  
**Version:** 4





## Safety Data Sheet

### 13. DISPOSAL CONSIDERATIONS

**Disposal methods:**

Refer to Waste Management Authority. Close valves of empty containers. Return empty containers to supplier using the same precautions as with filled containers.

### 14. TRANSPORT INFORMATION

**Road and Rail Transport**

Classified as Dangerous Goods by the criteria of the Australian Dangerous Goods Code (ADG Code) for Transport by Road and Rail; DANGEROUS GOODS.



**UN No:** 1005  
**Transport Hazard Class:** 2.3 Toxic Gas  
**Subrisk 1:** 8 Corrosive  
**Proper Shipping Name or Technical Name:** AMMONIA, ANHYDROUS

**Hazchem or Emergency Action Code:** 2RE

**Marine Transport**

Classified as Dangerous Goods by the criteria of the International Maritime Dangerous Goods Code (IMDG Code) for transport by sea; DANGEROUS GOODS.

**UN No:** 1005  
**Transport Hazard Class:** 2.3 Toxic Gas  
**Subrisk 1:** 8 Corrosive  
**Proper Shipping Name or Technical Name:** AMMONIA, ANHYDROUS

**IMDG EMS Fire:** F-C  
**IMDG EMS Spill:** S-U

**Air Transport**

Classified as Dangerous Goods by the criteria of the International Air Transport Association (IATA) Dangerous Goods Regulations for transport by air; DANGEROUS GOODS.  
TRANSPORT PROHIBITED under the International Air Transport Association (IATA) Dangerous Goods Regulations for transport by air in passenger aircraft and cargo aircraft.

**UN No:** 1005  
**Transport Hazard Class:** 2.3 Toxic Gas  
**Subrisk 1:** 8 Corrosive  
**Proper Shipping Name or Technical Name:** AMMONIA, ANHYDROUS

### 15. REGULATORY INFORMATION

**Classification:**

This material is hazardous according to Safe Work Australia; HAZARDOUS SUBSTANCE.

**Product Name:** AMMONIA - ANHYDROUS  
**Substance No:** 000031098301

**Issued:** 01/03/2013  
**Version:** 4



# Safety Data Sheet

## Gasoline, Unleaded

**NFPA:** Flammability



### SECTION 1. PRODUCT AND COMPANY IDENTIFICATION

<b>Product name</b>	:	Gasoline, Unleaded	
<b>Synonyms</b>	:	Blend of Highly Flammable Petroleum Distillates, Regular, Mid-Grade, Premium, 888100008809	
<b>SDS Number</b>	:	888100008809	<b>Version</b> : 1.1
<b>Product Use Description</b>	:	Fuel	
<b>Company</b>	:	For: Tesoro Refining & Marketing Co. 19100 Ridgewood Parkway, San Antonio, TX 78259	
<b>Tesoro Call Center</b>	:	(877) 783-7676	<b>Chemtrec (Emergency Contact)</b> : (800) 424-9300

### SECTION 2. HAZARDS IDENTIFICATION

**Classifications** : Flammable Liquid – Category 1 or 2 depending on formulation.  
Aspiration Hazard – Category 1  
Carcinogenicity – Category 2  
Specific Target Organ Toxicity (Repeated Exposure) – Category 2  
Specific Target Organ Toxicity (Single Exposure) – Category 3  
Skin Irritation – Category 2  
Eye Irritation – Category 2B  
Chronic Aquatic Toxicity – Category 2

**Pictograms** :



**Signal Word** : **Danger**

**Hazard Statements**

Extremely flammable liquid and vapor.  
May be fatal if swallowed and enters airways – do not siphon gasoline by mouth.  
Suspected of causing blood cancer if repeated over-exposure by inhalation and/or skin contact occurs.  
May cause damage to liver, kidneys and nervous system by repeated and prolonged inhalation or skin contact. Causes eye irritation. Can be absorbed through skin.  
May cause drowsiness or dizziness. Extreme exposure such as intentional inhalation may cause unconsciousness, asphyxiation and death.  
Repeated or prolonged skin contact can cause irritation and dermatitis.



**SAFETY DATA SHEET**

**GASOLINE, UNLEADED**

Harmful to aquatic life.

**Precautionary statements**

**Prevention**

- : Obtain special instructions before use.
- Do not handle until all safety precautions have been read and understood.
- Keep away from heat, sparks, open flames, welding and hot surfaces.
- No smoking.
- Keep container tightly closed.
- Ground and/or bond container and receiving equipment.
- Use explosion-proof electrical equipment.
- Use only non-sparking tools (if tools are used in flammable atmosphere).
- Take precautionary measures against static discharge.
- Wear gloves, eye protection and face protection (as needed to prevent skin and eye contact with liquid).
- Wash hands or liquid-contacted skin thoroughly after handling.
- Do not eat, drink or smoke when using this product.
- Do not breathe vapors.
- Use only outdoors or in a well-ventilated area.

**Response**

- : In case of fire: Use dry chemical, CO<sub>2</sub>, water spray or fire fighting foam to extinguish.
- If swallowed: Immediately call a poison center, doctor, hospital emergency room, medical clinic or 911. Do NOT induce vomiting. Rinse mouth.
- If on skin (or hair): Take off immediately all contaminated clothing. Rinse skin with water/shower.
- If in eye: Rinse cautiously with water for several minutes. Remove contact lenses, if present and easy to do. Continue rinsing.
- If skin or eye irritation persists, get medical attention.
- If inhaled: Remove person to fresh air and keep comfortable for breathing. Get medical attention if you feel unwell.

**Storage**

- : Store in a well ventilated place. Keep cool. Store locked up. Keep container tightly closed. Use only approved containers. Some containers not approved for gasoline may dissolve and release flammable gasoline liquid and vapors.

**Disposal**

- : Dispose of contents/containers to approved disposal site in accordance with local, regional, national, and/or international regulations.

**SECTION 3. COMPOSITION/INFORMATION ON INGREDIENTS**

Component	CAS-No.	Weight %
Gasoline, natural; Low boiling point naphtha	8006-61-9	10 - 30%
Toluene	108-88-3	10 - 30%
Xylene	1330-20-7	10 - 30%
Ethanol; ethyl alcohol	64-17-5	0-8.2%
Trimethylbenzene	25551-13-7	1 - 5%
Isopentane; 2-methylbutane	78-78-4	1 - 5%





SAFETY DATA SHEET		GASOLINE, UNLEADED		Page 3 of
Naphthalene	91-20-3		1 - 5%	
Benzene	71-43-2		Less than 1.3%	
Pentane	109-66-0		1 - 5%	
Cyclohexane	110-82-7		1 - 5%	
Ethylbenzene	100-41-4		1 - 5%	
Butane	106-97-8		1 - 20%	
Heptane [and isomers]	142-82-5		0.5 - 0.75%	
N-hexane	110-54-3		0.5 - 0.75%	
<b>SECTION 4. FIRST AID MEASURES</b>				
<b>Inhalation</b>	:	If inhaled, remove to fresh air. If not breathing, give artificial respiration. If breathing is difficult, give oxygen. Seek medical attention immediately.		
<b>Skin contact</b>	:	In case of contact, immediately flush skin with plenty of water. Take off contaminated clothing and shoes immediately. Wash contaminated clothing before re-use. Contaminated leather, particularly footwear, must be discarded. Note that contaminated clothing may be a fire hazard. Seek medical advice if symptoms persist or develop.		
<b>Eye contact</b>	:	Remove contact lenses. Rinse immediately with plenty of water, also under the eyelids, for at least 15 minutes. Seek medical advice if symptoms persist or develop.		
<b>Ingestion</b>	:	Do NOT induce vomiting. Never give anything by mouth to an unconscious person. Obtain medical attention.		
<b>Notes to physician</b>	:	Symptoms: Dizziness, Discomfort, Headache, Nausea, Kidney disorders, Liver disorders. Aspiration may cause pulmonary edema and pneumonitis. Swallowing gasoline is more likely to be fatal for small children than adults, even if aspiration does not occur.		
<b>SECTION 5. FIRE-FIGHTING MEASURES</b>				
<b>Suitable extinguishing media</b>	:	SMALL FIRES: Any extinguisher suitable for Class B fires, dry chemical, CO <sub>2</sub> , water spray or fire fighting foam. LARGE FIRES: Water spray, fog or fire fighting foam. Water may be ineffective for fighting the fire, but may be used to cool fire-exposed containers. Keep containers and surroundings cool with water spray.		
<b>Specific hazards during fire fighting</b>	:	Extremely flammable liquid and vapor. This material is combustible/flammable and is sensitive to fire, heat, and static discharge.		
<b>Special protective equipment for fire-fighters</b>	:	Firefighting activities that may result in potential exposure to high heat, smoke or toxic by-products of combustion should require NIOSH/MSHA- approved pressure demand self-contained breathing apparatus with full facepiece and full protective clothing.		
3 / 14				



**SAFETY DATA SHEET**

**GASOLINE, UNLEADED**

**Further information** : Isolate area around container involved in fire. Cool tanks, shells, and containers exposed to fire and excessive heat with water. For massive fires the use of unmanned hose holders or monitor nozzles may be advantageous to further minimize personnel exposure. Major fires may require withdrawal, allowing the tank to burn. Large storage tank fires typically require specially trained personnel and equipment to extinguish the fire, often including the need for properly applied fire fighting foam. Exposure to decomposition products may be a hazard to health. Use extinguishing measures that are appropriate to local circumstances and the surrounding environment. Use water spray to cool unopened containers. Fire residues and contaminated fire extinguishing water must be disposed of in accordance with local regulations.

**SECTION 6. ACCIDENTAL RELEASE MEASURES**

**Personal precautions** : Evacuate personnel to safe areas. Ventilate the area. Remove all sources of ignition. Response and clean-up crews must be properly trained and must utilize proper protective equipment (see Section 8).

**Environmental precautions** : Discharge into the environment must be avoided. If the product contaminates rivers and lakes or drains inform respective authorities.

**Methods for cleaning up** : Contain and collect spillage with non-combustible absorbent material, (e.g. sand, earth, diatomaceous earth, vermiculite) and place in container for disposal according to local / national regulations.

**SECTION 7. HANDLING AND STORAGE**

**Precautions for safe handling** : Keep away from fire, sparks and heated surfaces. No smoking near areas where material is stored or handled. The product should only be stored and handled in areas with intrinsically safe electrical classification.

Hydrocarbon liquids including this product can act as a non-conductive flammable liquid (or static accumulators), and may form ignitable vapor-air mixtures in storage tanks or other containers. Precautions to prevent static-initated fire or explosion during transfer, storage or handling, include but are not limited to these examples:

- (1) Ground and bond containers during product transfers. Grounding and bonding may not be adequate protection to prevent ignition or explosion of hydrocarbon liquids and vapors that are static accumulators.
- (2) Special slow load procedures for "switch loading" must be followed to avoid the static ignition hazard that can exist when higher flash point material (such as fuel oil or diesel) is loaded into tanks previously containing low flash point products (such gasoline or naphtha).
- (3) Storage tank level floats must be effectively bonded.

For more information on precautions to prevent static-initated fire or explosion, see NFPA 77, Recommended Practice on Static Electricity (2007), and API Recommended Practice 2003, Protection Against Ignitions Arising Out of Static, Lightning, and Stray Currents (2008).

**Conditions for safe storage, including incompatibilities** : Keep away from flame, sparks, excessive temperatures and open flame. Use approved containers. Keep containers closed and clearly labeled. Empty or partially full product containers or vessels may contain explosive vapors. Do not pressurize, cut, heat, weld or expose containers to sources of ignition. Store in a well-ventilated area. The storage area should comply with NFPA 30 "Flammable and Combustible Liquid Code". The cleaning of tanks previously containing this product should follow API Recommended Practice (RP) 2013 "Cleaning Mobile Tanks In Flammable and Combustible Liquid Service" and API RP 2015 "Cleaning Petroleum Storage Tanks".





**SAFETY DATA SHEET**

**GASOLINE, UNLEADED**

Reports suggest that government-mandated ethanol, if present, may not be compatible with fiberglass gasoline tanks. Ethanol may dissolve fiberglass resin, causing engine damage and possibly allow leakage of explosive gasoline.

Keep away from food, drink and animal feed. Incompatible with oxidizing agents. Incompatible with acids.

No decomposition if stored and applied as directed. Emergency eye wash capability should be available in the near proximity to operations presenting a potential splash exposure. Store only in containers approved and labeled for gasoline.

**SECTION 8. EXPOSURE CONTROLS / PERSONAL PROTECTION**

**Exposure Guidelines**

List	Components	CAS-No.	Type:	Value
OSHA	Benzene	71-43-2	TWA	1 ppm
		71-43-2	STEL	5 ppm
		71-43-2	OSHA_ACT	0.5 ppm
OSHA Z1	Xylene	1330-20-7	PEL	100 ppm 435 mg/m3
	Ethanol; Ethyl alcohol	64-17-5	PEL	1,000 ppm 1,900 mg/m3
	Naphthalene	91-20-3	PEL	10 ppm 50 mg/m3
	Cyclohexane	110-82-7	PEL	300 ppm 1,050 mg/m3
	Ethylbenzene	100-41-4	PEL	100 ppm 435 mg/m3
	Heptane [and isomers]	142-82-5	PEL	500 ppm 2,000 mg/m3
	N-hexane	110-54-3	PEL	500 ppm 1,800 mg/m3
ACGIH	Toluene	108-88-3	TWA	50 ppm
	Xylene	1330-20-7	TWA	100 ppm
		1330-20-7	STEL	150 ppm
	Ethanol; Ethyl alcohol	64-17-5	TWA	1,000 ppm
	Trimethylbenzene	25551-13-7	TWA	25 ppm
	Isopentane; 2-Methylbutane	78-78-4	TWA	600 ppm
	Naphthalene	91-20-3	TWA	10 ppm
		91-20-3	STEL	15 ppm
	Benzene	71-43-2	TWA	0.5 ppm
		71-43-2	STEL	2.5 ppm
	Pentane	109-66-0	TWA	600 ppm
	Cyclohexane	110-82-7	TWA	100 ppm
	Ethylbenzene	100-41-4	TWA	100 ppm
		100-41-4	STEL	125 ppm
Heptane [and isomers]	142-82-5	TWA	400 ppm	
	142-82-5	STEL	500 ppm	





**SAFETY DATA SHEET** **GASOLINE, UNLEADED** Page 6 of 14

	N-hexane	110-54-3	TWA	50 ppm
<b>Engineering measures</b>	: Use adequate ventilation to keep gas and vapor concentrations of this product below occupational exposure and flammability limits, particularly in confined spaces. Use only intrinsically safe electrical equipment approved for use in classified areas.			
<b>Eye protection</b>	: Safety glasses or goggles are recommended where there is a possibility of splashing or spraying. Ensure that eyewash stations and safety showers are close to the workstation location.			
<b>Hand protection</b>	: Gloves constructed of nitrile or neoprene are recommended. Consult manufacturer specifications for further information.			
<b>Skin and body protection</b>	: If needed to prevent skin contact, chemical protective clothing such as of DuPont TyChem®, Saranex or equivalent recommended based on degree of exposure. Flame resistant clothing such as Nomex ® is recommended in areas where material is stored or handled.			
<b>Respiratory protection</b>	: A NIOSH/ MSHA-approved air-purifying respirator with organic vapor cartridges or canister may be permissible under certain circumstances where airborne concentrations are or may be expected to exceed exposure limits or for odor or irritation. Protection provided by air-purifying respirators is limited. Refer to OSHA 29 CFR 1910.134, ANSI Z88.2-1992, NIOSH Respirator Decision Logic, and the manufacturer for additional guidance on respiratory protection selection. Use a NIOSH/ MSHA-approved positive-pressure supplied-air respirator if there is a potential for uncontrolled release, exposure levels are not known, in oxygen-deficient atmospheres, or any other circumstance where an air-purifying respirator may not provide adequate protection.			
<b>Work / Hygiene practices</b>	: Emergency eye wash capability should be available in the near proximity to operations presenting a potential splash exposure. Use good personal hygiene practices. Avoid repeated and/or prolonged skin exposure. Wash hands before eating, drinking, smoking, or using toilet facilities. Do not use as a cleaning solvent on the skin. Do not use solvents or harsh abrasive skin cleaners for washing this product from exposed skin areas. Waterless hand cleaners are effective. Promptly remove contaminated clothing and launder before reuse. Use care when laundering to prevent the formation of flammable vapors which could ignite via washer or dryer. Consider the need to discard contaminated leather shoes and gloves.			

**SECTION 9. PHYSICAL AND CHEMICAL PROPERTIES**

<b>Appearance</b>	: Clear to straw colored liquid
<b>Odor</b>	: Characteristic hydrocarbon-like
<b>Odor threshold</b>	0.5 - 1.1 ppm
<b>pH</b>	: Not applicable
<b>Melting point/freezing point</b>	About -101°C (-150°F)
<b>Initial boiling point &amp; range</b>	Boiling point varies: 30 – 200°C (85 – 392°F)
<b>Flash point</b>	< -21°C (-5.8°F)
<b>Evaporation rate</b>	: Higher initially and declining as lighter components evaporate
<b>Flammability (solid, gas)</b>	: Flammable vapor released by liquid



**SAFETY DATA SHEET** **GASOLINE, UNLEADED** Page 7 of 14

<b>Upper explosive limit</b>	7.6 %(V)
<b>Lower explosive limit</b>	1.3 %(V)
<b>Vapor pressure</b>	345 - 1,034 hPa at 37.8 °C (100.0 °F)
<b>Vapor density (air = 1)</b>	Approximately 3 to 4
<b>Relative density (water = 1)</b>	0.8 g/mL
<b>Solubility (in water)</b>	Negligible
<b>Partition coefficient (n-octanol/water)</b>	2 – 7 as log Pow
<b>Auto-ignition temperature</b>	Approximately 250°C (480°F)
<b>Decomposition temperature</b>	Will evaporate or boil and possibly ignite before decomposition occurs.
<b>Kinematic viscosity</b>	0.64 to 0.88 mm <sup>2</sup> /s range reported for gasoline
<b>Conductivity (conductivity can be reduced by environmental factors such as a decrease in temperature)</b>	: Hydrocarbon liquids without static dissipater additive may have conductivity below 1 picoSiemens per meter (pS/m). The highest electro-static ignition risks are associated with "ultra-low conductivities" below 5 pS/m. See Section 7 for sources of information on defining safe loading and handling procedures for low conductivity products.

**SECTION 10. STABILITY AND REACTIVITY**

<b>Reactivity</b>	: Vapors may form explosive mixture with air. Hazardous polymerization does not occur.
<b>Chemical stability</b>	: Stable under normal conditions.
<b>Possibility of hazardous reactions</b>	Can react with strong oxidizing agents, peroxides, alkaline products and strong acids. Contact with nitric and sulfuric acids will form nitrocresols that can decompose violently.
<b>Conditions to avoid</b>	: Avoid high temperatures, open flames, sparks, welding, smoking and other ignition sources. Avoid static charge accumulation and discharge (see Section 7).
<b>Hazardous decomposition products</b>	: Ignition and burning can release carbon monoxide, carbon dioxide and non-combusted hydrocarbons (smoke).

**SECTION 11. TOXICOLOGICAL INFORMATION**

<b>Skin contact</b>	: Irritating to skin. Can be partially absorbed through skin.
<b>Eye contact</b>	: Irritating to eyes.
<b>Ingestion</b>	: Aspiration hazard if liquid is inhaled into lungs, particularly from vomiting after ingestion. Aspiration may result in chemical pneumonia, severe lung damage, respiratory failure and even death. Ingestion may cause gastrointestinal disturbances, including irritation, nausea, vomiting and diarrhea, and central nervous (brain) effects similar to alcohol intoxication. In severe cases, tremors, convulsions, loss of consciousness, coma, respiratory arrest and death may occur.





**SAFETY DATA SHEET**

**GASOLINE, UNLEADED**

**Inhalation and further information**

Acute toxicity of benzene results primarily from depression of the central nervous system (CNS). Inhalation of concentrations over 50 ppm can produce headache, lassitude, weariness, dizziness, drowsiness, over excitation. Exposure to very high levels can result in unconsciousness and death.

Repeated over-exposure may cause liver and kidney injuries.  
 Components of the product may affect the nervous system.

IARC has determined that gasoline and gasoline exhaust are possibly carcinogenic in humans. Inhalation exposure to completely vaporized unleaded gasoline caused kidney cancers in male rats and liver tumors in female mice. The U.S. EPA has determined that the male kidney tumors are species-specific and are irrelevant for human health risk assessment. The significance of the tumors seen in female mice is not known. Exposure to light hydrocarbons in the same boiling range as this product has been associated in animal studies with effects to the central and peripheral nervous systems, liver, and kidneys. The significance of these animal models to predict similar human response to gasoline is uncertain. This product contains benzene. Human health studies indicate that prolonged and/or repeated overexposure to benzene may cause damage to the blood-forming system (particularly bone marrow), and serious blood disorders such as aplastic anemia and leukemia. Benzene is listed as a human carcinogen by the NTP, IARC, OSHA and ACGIH.

**Component:**

Gasoline, natural; Low boiling point naphtha 8006-61-9

Acute oral toxicity: LD50 rat  
 Dose: 18.8 mg/kg

Acute inhalation toxicity: LC50 rat  
 Dose: 20.7 mg/l  
 Exposure time: 4 h

Skin irritation: Classification: Irritating to skin.  
 Result: Mild skin irritation

Eye irritation: Classification: Irritating to eyes.  
 Result: Moderate eye irritation

Toluene

108-88-3

Acute oral toxicity: LD50 rat  
 Dose: 636 mg/kg

Acute dermal toxicity: LD50 rabbit  
 Dose: 12,124 mg/kg

Acute inhalation toxicity: LC50 rat  
 Dose: 49 mg/l  
 Exposure time: 4 h

Skin irritation: Classification: Irritating to skin.  
 Result: Mild skin irritation  
 Prolonged skin contact may defat the skin and produce dermatitis.

Eye irritation: Classification: Irritating to eyes.  
 Result: Mild eye irritation

Xylene

1330-20-7

Acute oral toxicity: LD50 rat  
 Dose: 2,840 mg/kg

Acute dermal toxicity: LD50 rabbit  
 Dose: ca. 4,500 mg/kg

Acute inhalation toxicity: LC50 rat  
 Dose: 6,350 mg/l  
 Exposure time: 4 h

Skin irritation: Classification: Irritating to skin.  
 Result: Mild skin irritation



SAFETY DATA SHEET		GASOLINE, UNLEADED		Page 9 of 14
<b>Ethanol; Ethyl alcohol</b>	64-17-5	<p>Repeated or prolonged exposure may cause skin irritation and dermatitis, due to degreasing properties of the product.  <u>Eye irritation:</u> Classification: Irritating to eyes.                      Result: Mild eye irritation</p> <p><u>Acute oral toxicity:</u> LD50 rat                      Dose: 6,200 mg/kg</p> <p><u>Acute dermal toxicity:</u> LD50 rabbit                      Dose: 19,999 mg/kg</p> <p><u>Acute inhalation toxicity:</u> LC50 rat                      Dose: 8,001 mg/l                      Exposure time: 4 h</p> <p><u>Skin irritation:</u> Classification: Irritating to skin.                      Result: Mild skin irritation                      Prolonged skin contact may cause skin irritation and/or dermatitis.  <u>Eye irritation:</u> Classification: Irritating to eyes.                      Result: Mild eye irritation                      Mild eye irritation</p>		
<b>Naphthalene</b>	91-20-3	<p><u>Acute oral toxicity:</u> LD50 rat                      Dose: 2,001 mg/kg</p> <p><u>Acute dermal toxicity:</u> LD50 rat                      Dose: 2,501 mg/kg</p> <p><u>Acute inhalation toxicity:</u> LC50 rat                      Dose: 101 mg/l                      Exposure time: 4 h</p> <p><u>Skin irritation:</u> Classification: Irritating to skin.                      Result: Mild skin irritation</p> <p><u>Eye irritation:</u> Classification: Irritating to eyes.                      Result: Mild eye irritation</p>		
<b>Benzene</b>	71-43-2	<p><u>Acute oral toxicity:</u> LD50 rat                      Dose: 930 mg/kg</p> <p><u>Acute inhalation toxicity:</u> LC50 rat                      Dose: 44 mg/l                      Exposure time: 4 h</p> <p><u>Skin irritation:</u> Classification: Irritating to skin.                      Result: Mild skin irritation                      Repeated or prolonged exposure may cause skin irritation and dermatitis, due to degreasing properties of the product.  <u>Eye irritation:</u> Classification: Irritating to eyes.                      Result: Risk of serious damage to eyes.</p>		
<b>Pentane</b>	109-66-0	<p><u>Acute oral toxicity:</u> LD50 rat                      Dose: 2,001 mg/kg</p> <p><u>Acute inhalation toxicity:</u> LC50 rat                      Dose: 364 mg/l                      Exposure time: 4 h</p> <p><u>Skin irritation:</u> Repeated or prolonged exposure may cause skin irritation and dermatitis, due to degreasing properties of the product.  <u>Eye irritation:</u> Classification: Irritating to eyes.                      Result: Mild eye irritation</p>		
<b>Cyclohexane</b>	110-82-7	<p><u>Acute dermal toxicity:</u> LD50 rabbit                      Dose: 2,001 mg/kg</p> <p><u>Acute inhalation toxicity:</u> LC50 rat                      Dose: 14 mg/l                      Exposure time: 4 h</p>		



SAFETY DATA SHEET		GASOLINE, UNLEADED		Page 10 of 14
			<p><u>Skin irritation:</u> Classification: Irritating to skin. Result: Skin irritation</p> <p><u>Eye irritation:</u> Classification: Irritating to eyes. Result: Mild eye irritation</p>	
<b>Ethylbenzene</b>	100-41-4		<p><u>Acute oral toxicity:</u> LD50 rat Dose: 3,500 mg/kg</p> <p><u>Acute dermal toxicity:</u> LD50 rabbit Dose: 15,500 mg/kg</p> <p><u>Acute inhalation toxicity:</u> LC50 rat Dose: 18 mg/l Exposure time: 4 h</p> <p><u>Skin irritation:</u> Classification: Irritating to skin. Result: Mild skin irritation</p> <p><u>Eye irritation:</u> Classification: Irritating to eyes. Result: Risk of serious damage to eyes.</p>	
<b>Heptane [and isomers]</b>	142-82-5		<p><u>Acute oral toxicity:</u> LD50 rat Dose: 15,001 mg/kg</p> <p><u>Acute inhalation toxicity:</u> LC50 rat Dose: 103 g/m3 Exposure time: 4 h</p> <p><u>Skin irritation:</u> Classification: Irritating to skin. Result: Skin irritation Repeated or prolonged exposure may cause skin irritation and dermatitis, due to degreasing properties of the product.</p> <p><u>Eye irritation:</u> Classification: Irritating to eyes. Result: Mild eye irritation</p>	
<b>N-hexane</b>	110-54-3		<p><u>Acute oral toxicity:</u> LD50 rat Dose: 25,000 mg/kg</p> <p><u>Acute dermal toxicity:</u> LD50 rabbit Dose: 2,001 mg/kg</p> <p><u>Acute inhalation toxicity:</u> LC50 rat Dose: 171.6 mg/l Exposure time: 4 h</p> <p><u>Skin irritation:</u> Classification: Irritating to skin. Result: Skin irritation</p> <p><u>Eye irritation:</u> Classification: Irritating to eyes. Result: Mild eye irritation</p> <p><u>Teratogenicity:</u> N11,00418960</p>	
<b><u>Carcinogenicity</u></b>				
<b>NTP</b>		:	Naphthalene (CAS-No.: 91-20-3) Benzene (CAS-No.: 71-43-2)	
<b>IARC</b>		:	Gasoline, natural; Low boiling point naphtha (CAS-No.: 8006-61-9) Naphthalene (CAS-No.: 91-20-3) Benzene (CAS-No.: 71-43-2) Ethylbenzene (CAS-No.: 100-41-4)	
<b>OSHA</b>		:	Benzene (CAS-No.: 71-43-2)	
<b>CA Prop 65</b>		:	WARNING! This product contains a chemical known to the State of California to cause birth defects or other reproductive harm. Toluene (CAS-No.: 108-88-3)	
10 / 14				



**SAFETY DATA SHEET**

**GASOLINE, UNLEADED**

Benzene (CAS-No.: 71-43-2)

**SECTION 12. ECOLOGICAL INFORMATION**

**Additional ecological information** : Keep out of sewers, drainage areas, and waterways. Report spills and releases, as applicable, under Federal and State regulations.

**Component:**

Toluene	108-88-3	<p><u>Toxicity to fish:</u> LC50 Species: Carassius auratus (goldfish) Dose: 13 mg/l Exposure time: 96 h</p> <p><u>Acute and prolonged toxicity for aquatic invertebrates:</u> EC50 Species: Daphnia magna (Water flea) Dose: 11.5 mg/l Exposure time: 48 h</p> <p><u>Toxicity to algae:</u> IC50 Species: Selenastrum capricornutum (green algae) Dose: 12 mg/l Exposure time: 72 h</p>
Ethanol; Ethyl alcohol	64-17-5	<p><u>Toxicity to fish:</u> LC50 Species: Leuciscus idus (Golden orfe) Dose: 8,140 mg/l Exposure time: 48 h</p> <p><u>Acute and prolonged toxicity for aquatic invertebrates:</u> EC50 Species: Daphnia magna (Water flea) Dose: 9,268 - 14,221 mg/l Exposure time: 48 h</p>
Isopentane; 2-Methylbutane	78-78-4	<p><u>Toxicity to fish:</u> LC50 Species: Oncorhynchus mykiss (rainbow trout) Dose: 3.1 mg/l Exposure time: 96 h</p> <p><u>Acute and prolonged toxicity for aquatic invertebrates:</u> EC50 Species: Daphnia magna (Water flea) Dose: 2.3 mg/l Exposure time: 96 h</p>
Naphthalene	91-20-3	<p><u>Toxicity to algae:</u> EC50 Species: Dose: 33 mg/l Exposure time: 24 h</p>
Pentane	109-66-0	<p><u>Acute and prolonged toxicity for aquatic invertebrates:</u> EC50 Species: Daphnia magna (Water flea) Dose: 9.74 mg/l Exposure time: 48 h</p>
Cyclohexane	110-82-7	<p><u>Acute and prolonged toxicity for aquatic invertebrates:</u> EC50 Species: Daphnia magna (Water flea) Dose: 3.78 mg/l Exposure time: 48 h</p>





**SAFETY DATA SHEET** **GASOLINE, UNLEADED** Page 12 of 14

**Heptane [and isomers]** 142-82-5

Toxicity to fish:  
 LC50  
 Species: Carassius auratus (goldfish)  
 Dose: 4 mg/l  
 Exposure time: 24 h

Acute and prolonged toxicity for aquatic invertebrates:  
 EC50  
 Species: Daphnia magna (Water flea)  
 Dose: 1.5 mg/l  
 Exposure time: 48 h

**N-hexane** 110-54-3

Toxicity to fish:  
 LC50  
 Species: Pimephales promelas (fathead minnow)  
 Dose: 2.5 mg/l  
 Exposure time: 96 h

Acute and prolonged toxicity for aquatic invertebrates:  
 EC50  
 Species: Daphnia magna (Water flea)  
 Dose: 2.1 mg/l  
 Exposure time: 48 h

**SECTION 13. DISPOSAL CONSIDERATIONS**

**Disposal** : Dispose of container and unused contents in accordance with federal, state and local requirements.

**SECTION 14. TRANSPORT INFORMATION**

**CFR**

Proper shipping name : Petrol  
 UN-No. : 1203  
 Class : 3  
 Packing group : II

**TDG**

Proper shipping name : Gasoline  
 UN-No. : UN1203  
 Class : 3  
 Packing group : II

**IATA Cargo Transport**

UN UN-No. : UN1203  
 Description of the goods : Gasoline  
 Class : 3  
 Packaging group : II  
 ICAO-Labels : 3  
 Packing instruction (cargo aircraft) : 364  
 Packing instruction (cargo aircraft) : Y341

**IATA Passenger Transport**

UN UN-No. : UN1203  
 Description of the goods : Gasoline  
 Class : 3



**SAFETY DATA SHEET** **GASOLINE, UNLEADED** Page 13 of 14

Packaging group : II  
 ICAO-Labels : 3  
 Packing instruction (passenger aircraft) : 353  
 Packing instruction (passenger aircraft) : Y341

**IMDG-Code**

UN-No. : UN 1203  
 Description of the goods : Gasoline  
 Class : 3  
 Packaging group : II  
 IMDG-Labels : 3  
 EmS Number : F-E S-E  
 Marine pollutant : No

**SECTION 15. REGULATORY INFORMATION**

OSHA Hazards : Flammable liquid  
 Highly toxic by ingestion  
 Moderate skin irritant  
 Severe eye irritant  
 Carcinogen

TSCA Status : On TSCA Inventory

DSL Status : . All components are on the Canadian DSL list.

SARA 311/312 Hazards : Fire Hazard  
 Acute Health Hazard  
 Chronic Health Hazard

**CERCLA SECTION 103 and SARA SECTION 304 (RELEASE TO THE ENVIROMENT)**  
 The CERCLA definition of hazardous substances contains a "petroleum exclusion" clause which exempts crude oil. Fractions of crude oil, and products (both finished and intermediate) from the crude oil refining process and any indigenous components of such from the CERCLA Section 103 reporting requirements. However, other federal reporting requirements, including SARA Section 304, as well as the Clean Water Act may still apply.

California Prop. 65 : WARNING! This product contains a chemical known to the State of California to cause birth defects or other reproductive harm.

Toluene 108-88-3  
 Benzene 71-43-2

**SECTION 16. OTHER INFORMATION**

Further information

The information provided in this Safety Data Sheet is correct to the best of our knowledge, information and belief at the date of its publication. The information given is designed only as guidance for safe handling, use, processing, storage, transportation, disposal and release and is not to be considered a warranty or quality specification. The information relates only to the specific material designated and may not be valid for such material used in combination with any other materials or in any process, unless specified in the text.



**SAFETY DATA SHEET**

**GASOLINE, UNLEADED**

Page 14 of  
14

Revision Date : 08/09/2012

6, 8, 10, 12, 14, 16, 64, 68, 91, 112, 306, 1092, 1106, 1500, 1570, 1571, 1651, 1652, 1654, 1700, 1701, 1702, 1710, 1711, 1714, 1726, 1729, 1730, 1732, 1733, 1826, 1848, 1880, 1950



Page left blank intentionally.



## Tier II Reports

Every year, facilities covered by the Emergency Planning and Community Right to Know Act (EPCRA) must submit an emergency and hazardous chemical inventory form to the LEPC, the SERC, and the local fire department. Facilities complete either a Tier I or a Tier II form. Most facilities choose the Tier II form. Tier II forms require basic facility identification information, employee contact information for both emergencies and non-emergencies, and information about chemicals stored or used at the facility, including:

- The chemical name or the common name and health hazards as indicated on the SDS
- An estimate of the maximum amount of the chemical present at any time during the previous calendar year and the average daily amount
- A brief description of the container and conditions in which the chemical is stored
- The location of the chemical at the facility
- An indication of whether the owner of the facility elects to withhold location information from disclosure to the public
- Emergency contacts

### Threshold Planning Quantities (TPQ)

Threshold Planning Quantities (TPQ) for Extremely Hazardous Substances (EHS) are defined by SARA. Please note that the TPQ for all of the EHS is either the TPQ listed or 500 lbs., whichever is lower.

For any chemical that is not an EHS, but is a Hazardous Chemical under OSHA regulations, and therefore requires the preparation and availability of a SDS, the TPQ is 10,000 lbs.

### Extremely Hazardous Substances (EHS)

EHS include any of the 406 chemicals identified by EPA as toxic, and listed under SARA Title III. The list is subject to periodic revision.





## Contents of a Tier II Report

### Facility Identification

Every location of chemicals within a facility is required to have a separate, completed report including full name and address.

### Emergency Contacts

This section includes space to record the name, address and phone number of the facility owner or operator.

### Chemical Description, Hazards, Amounts, Locations

Specific information concerning the nature of the stored chemicals is required to be included, and is provided to emergency personnel to aid response. The inventory section asks for a maximum daily amount, the average daily amount, and the total number of days/year the chemical is present at the facility. The form also includes space to report the type of container each chemical is stored in, whether it is stored under pressure or held at other than normal temperature.

### Certification

The owner, operator, or officially designated representative of the facility must certify that all information included in the Tier II Report is true, accurate, and complete before filing it with the Department of Environmental Quality.



Check if information below is identical to the information submitted last year. Reporting Period: January 1 to December 31, 20\_\_

<b>Tier Two Emergency and Hazardous Chemical Inventory</b>		<i>Specific Information by Chemical</i>		<b>For Official Use Only</b>	
				State ID#: Date Received	
<b>Facility Identification</b>					
Name		Maximum No. of Occupants: <input type="checkbox"/> N/A		<input type="checkbox"/> Manned <input type="checkbox"/> Unmanned	
Street		County		City State Zip	
Latitude		Longitude		NAICS Code Phone Number (optional) ( )	
Dun & Bradstreet Number		TRI Facility ID: <input type="checkbox"/> N/A		RMP Facility ID: <input type="checkbox"/> N/A	
Subject to Emergency Planning under Section 302 of EPCRA (40 CFR part 355)?				<input type="checkbox"/> Yes <input type="checkbox"/> No	
Subject to Chemical Accident Prevention under Section 112(r) of CAA (40 CFR part 68, Risk Management Program)?				<input type="checkbox"/> Yes <input type="checkbox"/> No	
<b>Owner or Operator Information</b>			<b>Parent Company Information (optional)</b>		
Name			Name Dun & Bradstreet Number:		
Address			Address		
Phone Number		Email		Phone Number Email ( )	
<b>Facility Emergency Coordinator (if applicable)</b>			<b>Tier II Information Contact</b>		
Name		Title		Name Title	
Email Address			Email Address		
Phone Number		24-hour Phone		Phone Number ( ) ( )	
<b>Emergency Contacts</b>					
Name			Name		
Title			Title		
Phone Number		24-hour Phone		Phone Number 24-hour Phone ( ) ( )	
Email Address			Email Address		
<b>Certification (Read and sign after completing all sections)</b>			<b>Reporting Ranges Weight Range in pounds</b>		
I certify under penalty of law that I have personally examined and am familiar with the information submitted in pages one through _____, and that based on my inquiry of those individuals responsible for obtaining the information, I believe that the submitted information is true, accurate and complete.  Name and official title of owner/operator OR owner/operator's authorized representative  Signature _____ Date Signed _____			<b>Range Code</b>	<b>From</b>	<b>To</b>
			01	0	99
			02	100	499
			03	500	999
			04	1,000	4,999
			05	5,000	9,999
			06	10,000	24,999
			07	25,000	49,999
			08	50,000	74,999
			09	75,000	99,999
			10	100,000	499,999
			11	500,000	999,999
			12	1,000,000	9,999,999
13	10,000,000	Greater than 10 million			
The public reporting and recordkeeping burden for this collection of information is estimated to range from 6 to 120 hours per response. Send comments on the Agency's need for this information, the accuracy of the provided burden estimates, and any suggested methods for minimizing respondent burden, including through the use of automated collection techniques to the Director, Collection Strategies Division, U.S. Environmental Protection Agency (2822T), 1200 Pennsylvania Ave., NW, Washington, D.C. 20460. Include the OMB control number in any correspondence. Do not send the completed form to this address.					

EPA Form No. 8700-30

OMB Control No. 2050-0072 Expiration Date: 03/31/2016

Page 1 of \_\_



EPA Form No. 8700-30

OMB Control No. 2050-0072 Expiration Date: 03/31/2016

Page \_\_\_ of \_\_\_

Chemical Description		Physical and Health Hazards		Inventory		Type of Storage	Storage Conditions (Pressure, Temperature)	Storage Locations	Additional Reporting Information (Optional)
<input type="checkbox"/> Check if information below is identical to the information submitted last year.  <b>Chemical Name:</b> CAS No.      EHS: Yes <input type="checkbox"/> No <input type="checkbox"/> <input type="checkbox"/> Solid <input type="checkbox"/> Liquid <input type="checkbox"/> Gas <input type="checkbox"/> Trade Secret		<input type="checkbox"/> Fire <input type="checkbox"/> Sudden Release of Pressure <input type="checkbox"/> Reactive <input type="checkbox"/> Immediate (Acute) <input type="checkbox"/> Delayed (Chronic)		Maximum Amount <b>Range Code:</b>  Average Daily Amount <b>Range Code:</b>  No. of days on site:				Confidential: <input type="checkbox"/> Yes <input type="checkbox"/> No	<input type="checkbox"/> Below Reporting Thresholds (optional)  <input type="checkbox"/> State or Local Requirements
<input type="checkbox"/> Check if information below is identical to the information submitted last year.  <b>Mixture or Product Name:</b> <input type="checkbox"/> Not Available CAS No. <input type="checkbox"/> Not Available <input type="checkbox"/> Solid <input type="checkbox"/> Liquid <input type="checkbox"/> Gas <input type="checkbox"/> Trade Secret EHS: Yes <input type="checkbox"/> No <input type="checkbox"/>  EHS(s) Name (if applicable):  CAS No.  Non-EHS(s) Name (optional):		<input type="checkbox"/> Fire <input type="checkbox"/> Sudden Release of Pressure <input type="checkbox"/> Reactive <input type="checkbox"/> Immediate (Acute) <input type="checkbox"/> Delayed (Chronic)		Maximum Amount (Total Mixture) <b>Range Code:</b>  Average Daily Amount (Total Mixture) <b>Range Code:</b>  No. of days on site:  Maximum Amount of each EHS in the Mixture <b>Range Code:</b>				Confidential: <input type="checkbox"/> Yes <input type="checkbox"/> No	<input type="checkbox"/> Below Reporting Thresholds (optional)  <input type="checkbox"/> State or Local Requirements

**Optional Attachments:**     I have attached a site plan     I have attached a list of site coordinate abbreviations  
 I have attached a description of dikes and other safeguard measures



Work with your team members to respond to this set of events.



A low pressure cargo tank truck has just filled up at a major gasoline distribution terminal and is in the process of making deliveries. After leaving the terminal, the driver has to travel on the interstate within the city limits of a major metropolitan area. Traveling east after reaching the freeway, the truck approaches a junction where the interstates meet. The time of day is approximately 1030 hours.

The driver smells smoke while traveling along the interstate, and pulls to the side of the highway to investigate. When he leaves the cab of the tractor, he notices that he has a brake fire on the passenger side of the tractor. He immediately grabs a 20-pound dry chemical extinguisher and proceeds to fight the fire. He depletes the dry chemical without suppressing the fire, which is impinging on the fuel saddle tank. Both tanks on the tractor are full, the driver having just started his delivery route.

In the area, a state highway administration safety vehicle notices the smoke and responds. This vehicle patrols the interstate and helps drivers in need of fuel, flat tires, etc. The driver of this vehicle calls the fire department and reports a tank truck on fire at the junction of Hwy 1 and Hwy 5. Upon arrival, the state highway employee grabs a dry chemical extinguisher and also tries to extinguish the blaze, again without success. The fire has extended to the cab of the tractor, which becomes fully involved within a matter of moments. The shipping papers, located in the door pocket of the cab, go up in flames.

The interstate is three lanes in both directions with an emergency shoulder lane. Ramps from the interchange are approximately 75 feet from the incident. There is no water supply on the freeway itself. A creek on one side within a heavily wooded area borders the interstate. The creek is not accessible for drafting. The closest water supply is across all lanes of traffic in a nearby residential area.

1. **What placard would be on this cargo tanker?**

---

2. **What color would the placard be, and what hazard class is the product?**

---

3. **How many placards would be required on this truck, and where would they be placed?**

---

4. **Is this vehicle carrying a single product or multiple products? How can you tell?**

---

5. **In order to address the health and safety concerns of first responders, what would your initial action be?**

---



Page left blank intentionally.





## Lesson 2.8 - Container Shapes and Sizes

### Lesson Objectives<sup>1</sup>

#### NFPA® 472, 4.2.1

Identify typical container shapes that can indicate the presence of hazmats/WMDs. (6)

Identify pipeline markings and colors that indicate hazmats/WMDs. (7)  
(e)

#### NFPA® 472, 5.2.1

Collect information about an incident to identify the containers, the materials involved, the surrounding conditions and whether hazmats/WMDs have been released.

#### NFPA® 472, 5.2.1.1

Given three examples each of liquid, gas and solid hazardous material or WMD, including various hazard classes, identify the general shapes of containers in which the hazmats/WMDs are typically found.

#### NFPA® 472, 5.2.1.1.1

Given examples of tank cars, identify each tank car by type:

- (1) Cryogenic liquid tank cars
- (2) Nonpressure tank cars (general service or low pressure cars)
- (3) Pressure tank cars

#### NFPA® 472, 5.2.1.1.2

Given examples of intermodal tanks, identify each intermodal tank by type:

- (1) Nonpressure intermodal tanks
- (2) Pressure intermodal tanks
- (3) Specialized intermodal tanks, including:
  - (a) Cryogenic intermodal tanks
  - (b) Tube modules

#### NFPA® 472, 5.2.1.1.3

Given examples of cargo tanks, identify each cargo tank by type:

- (1) Compressed gas tube trailers
- (2) Corrosive liquid tanks
- (3) Cryogenic liquid tanks
- (4) Dry bulk cargo tanks
- (5) High pressure tanks
- (6) Low pressure chemical tanks
- (7) Nonpressure liquid tanks



The ability to recognize hazardous materials is particularly important in transportation accidents, especially if little or no information is initially available.

The shape, size and design of containers used in transportation and storage may provide clues about the type and physical state of the material in the container, and indicate if the contents include hazardous materials.

Container shape may indicate whether the material is kept under pressure (capable of explosive release). A compressed gas, for example, is typically transported in a cylindrical container with rounded ends. Because some compressed gases can be quite dangerous, it is important to **use extreme caution when approaching an emergency situation involving a container with rounded ends.**



<sup>1</sup> NFPA 472® Standard for Competence of Responders to Hazardous Materials/Weapons of Mass Destruction, 2013 Edition.



**NFPA® 472, 5.2.1.1.4**

Given examples of storage tanks, identify each tank by type:

- (1) Cryogenic liquid tank
- (2) Nonpressure tank
- (3) Pressure tank

**NFPA® 472, 5.2.1.1.5**

Given examples of nonbulk packaging, identify each package by type:

- (1) Bags
- (2) Carboys
- (3) Cylinders
- (4) Drums
- (5) Dewar flask (cryogenic liquids)

**NFPA® 472, 5.2.1.1.6**

Given examples of packaging, identify the characteristics of each container or package by type:

- (1) Intermediate bulk container (IBC)
- (2) Ton container

**NFPA® 472, 5.2.1.1.7**

Given examples of radioactive material packages, identify the characteristics of each container or package by type:

- (1) Excepted
- (2) Industrial
- (3) Type A
- (4) Type B
- (5) Type C

**NFPA® 472, 5.2.1.2**

Given examples of containers, identify the markings that differentiate one container from another.

**NFPA® 472, 5.2.1.2.1**

Given examples of marked transport vehicles and their corresponding shipping papers, identify the vehicle or tank identification marking:

- (1) Highway transport vehicles, including cargo tanks
- (2) Intermodal equipment, including tank containers
- (3) Rail transport vehicles, including tank cars

**NFPA® 472, 5.2.1.2.2**

Given examples of facility containers, identify the markings indicating container size, product contained and/or site identification numbers.

**NFPA® 472, 5.2.1.3.1**

Identify the following information on a pipeline marker:

- (1) Emergency telephone number
- (2) Owner
- (3) Product



**NFPA® 472, 5.2.3**

Given scenarios involving hazmat/WMD incidents, each with a single hazardous material/WMD, describe the likely behavior of the material or agent and its container.

- (2) Identify three types of stress that can cause a container system to release its contents.
- (3) Identify five ways in which containers can breach.
- (4) Identify four ways in which containers can release their contents.
- (5) Identify at least four dispersion patterns that can be created upon release of a hazardous material.
- (6) Identify the time frames for estimating the duration that hazardous materials/WMD will present an exposure risk.
- (7) Identify the health and physical hazards that could cause harm.



Page left blank intentionally.



## Container Classification

There are two types of containers used to transport hazardous materials:

- Large bulk containers
- Smaller non-bulk containers

Bulk containers include highway cargo tanks and rail cars. Containers are classified as bulk when their capacities meet or exceed the following quantities.

- Maximum capacity of more than 119 gallons for liquids
- Maximum net capacity of more than 882 pounds for solids
- Water capacity greater than 1,000 pounds for gases

Note: All other containers, classified as non-bulk, have far less capacity.

Railroad, highway tanks and intermodal forms of transportation share a commonality in that all three carry:

- Non-pressure containers
- Pressure containers
- Cryogenic containers

**Pressurized tanks pose the most potential danger**, so their size, shape and identifiable features form valuable clues leading to quick, safe resolution of any problems that arise.





## Bulk Storage Tanks

Most storage tanks are designed to meet the specific characteristics of certain commodities. Tanks are built to withstand the properties of their intended contents. **Markings may include product name, site identification tank number, tank capacity and sometimes an emergency contact number.** Like other forms of storage and transportation containers, fixed facility storage tanks have certain revealing characteristics. For example:

- Atmospheric tanks, or tanks under low pressure, generally have flat ends or cone roofs. Most of these tanks are equipped with some type of vent or pressure/vacuum relief device.
- Pressurized tanks have rounded ends and pressure relief valves that may be visible.

The diagrams on the following pages illustrate the variety of atmospheric, low pressure, pressurized and cryogenic bulk storage tanks that can frequently be found at fixed sites.



**What are some of the problems experienced with above-ground bulk storage tanks?**

---

---

---

---

---

---

---

---



## Open Floating Roof Tank

**Open floating roof tanks contain flammable and combustible liquids (gasoline and crude oil are common).** Emergency responders at the operations level should not enter the inside roof area of this tank without specialized training and assistance from facility personnel.

Some of these tanks are in excess of 200 feet in diameter. Tank shell thickness varies with the diameter. **Identifying features include a wind girder around the top of the tank and a ladder to the roof.**

The roof is a pontoon that floats on top of the product, reducing vapors in the tank's top. The roofs are equipped with drains to remove rain water. There are several different types of seals that are used between the tank shell and the floating roof. Fires caused by lightning strikes are common in these seal areas.

Fire control in large diameter floating roof tanks usually takes more resources than most fire departments have. Extinguishing fires in these tanks takes extensive pre-incident planning efforts and the resources of multiple agencies. Many of these tanks are equipped with fixed foam systems that are painted red, and visible from all sides of the tank. During fires in crude oil tanks, water in the tank bottom may convert to steam, resulting in a boil over.

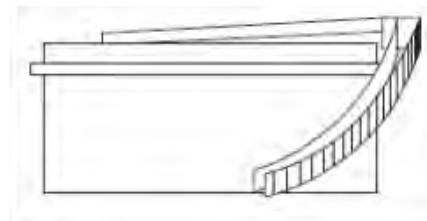

### Construction

- ▶ Roof floats on contents and moves up and down with varying levels
- ▶ Has a ladder along the side

### Contents

- ▶ Flammable liquids
- ▶ Combustible liquids

## Open Floating Roof Tank with Geodesic Dome

**These tanks contain flammable liquids (e.g., finished products like gasoline, jet fuel and diesel).** Responders should not enter the dome area. A permit is required to enter this confined space.

These tanks are the same as open roof tanks, except they are **equipped with a lightweight aluminum or composite material geodesic dome to prevent vapor emissions and to keep water and snow off the roof.** Responders at the operations level should not open dome roof access hatches or enter these areas. The area between the floating roof and the dome could contain dangerous concentrations of oxygen-deficient vapors.

Many of these tanks are equipped with fixed foam extinguishing systems. Fire fighting and logistical needs are generally the same as for those encountered with any large diameter floating roof tank.

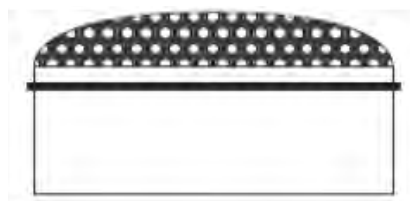

### Construction

Same design as an open floater, except it is covered by a geodesic dome

### Contents

- ▶ Flammable liquids
- ▶ Combustible liquids

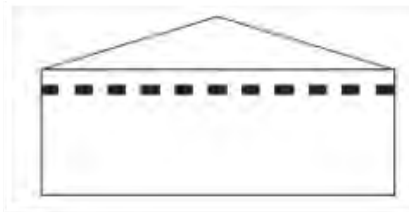

#### Construction

- ▶ Fixed cone-shaped roof covers inner floating roof
- ▶ Vents around the top side of the tank

#### Contents

- ▶ Flammable liquids
- ▶ Combustible liquids

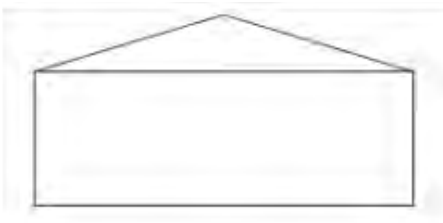

#### Construction

Circular, with a cone-shaped roof

#### Contents

- ▶ Flammable liquids
- ▶ Combustible liquids
- ▶ Corrosives
- ▶ Non-hazardous materials

## Covered Floating Roof Tank

Covered floating roof tanks contain flammable liquids (e.g., finished products like gasoline, jet fuel, diesel). Responders should not enter the covered area of these tanks (permit-required confined space). As with the cone roof tank, **responders should NEVER walk on the roofs of these tanks.** Internal corrosion can weaken the roof, creating a severe life hazard to responders.

Covered floating roof tanks are basically the same as the open floating roof tanks with a geodesic dome, except that the roof assembly will not fail as quickly during a fire as would the lighter weight geodesic dome.

## Cone Roof Tank

Cone roof tanks usually contain flammable or combustible liquids. Some store corrosives and hazardous waste, posing a variety of hazards. Responders should NEVER walk on tank roofs. Internal corrosion can weaken the roof, creating a severe life hazard to responders.

Cone roof tanks have vertical walls that support a cone roof. The tank shell thickness varies with the diameter of the tank.

Most are atmospheric pressure tanks (0–0.5 psig). Pressure/vacuum vents are located on top of the roof, and are sometimes visible from the ground.

Cone roof tanks have a weak roof-to-shell seam purposefully designed to fail during an internal explosion. Insulation is common on these tanks that store heavy oils, molten sulfur and asphalt. Containment walls or dikes are designed to hold at least the contents of a full tank.

When responders encounter hazardous waste stored in these tanks, they should be aware of product contamination that can multiply hazards. For example, spent sulfuric acid occasionally contains hydrocarbons which add flammability potential to the corrosive material.



## Underground Storage Tank (UST)

Underground storage tanks contain flammable and combustible liquids and other hazardous materials such as compressed gases or liquids, including gasoline and dry cleaning chemicals. USTs are considered low pressure or atmospheric pressure tanks. These tanks are constructed of composite steel and fiberglass.

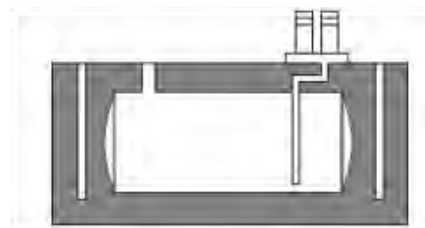

### Construction

Gauges and controls are above ground

### Contents

- ▶ Liquids and gases
- ▶ Usually contains petroleum products

## Dome Roof Tank

Dome roof tanks contain flammable and combustible liquids, fertilizers and chemical solvents. Operating pressures are 2.5 – 15 psig, depending on the product stored.

Dome roof tanks are considered low pressure, however some of these vertical dome roof tanks resemble higher pressure tanks designed to store liquefied petroleum gas (LPG) and anhydrous ammonia. Responders should always gather further information from facility personnel or documents before drawing conclusions about tank contents. Some of these tanks are insulated to maintain product temperature.

Tanks are equipped with pressure relief devices located on top of the tank. Dome roof tanks are sometimes equipped with fixed water deluge systems to protect the tank shell in the event of fire exposure.

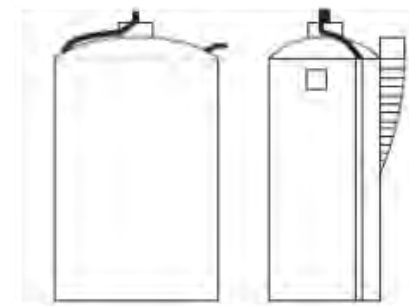

### Construction

- ▶ Vertical rather than horizontal
- ▶ Fixed dome-shaped roof
- ▶ Internal pressure up to 15 psi

### Contents

- ▶ Flammable liquids
- ▶ Combustible liquids
- ▶ Corrosive liquids
- ▶ Fertilizers
- ▶ Chemical solvents
- ▶ Non-hazardous materials



### Construction

- ▶ Horizontal tank on legs or blocks
- ▶ Use is restricted or banned because of susceptibility to tank/leg failure

### Contents

- ▶ Flammable liquids
- ▶ Combustible liquids
- ▶ Corrosives
- ▶ Poisons



## Horizontal Tank

**Horizontal tanks contain flammable and combustible liquids, corrosives, poisons, fertilizers and some non-hazardous products.**

They are considered to be a low pressure or atmospheric pressure tank. These tanks are mounted above ground on legs, saddles or blocks.

The structural integrity of the tank supports is critical to safety. If the supports fail, the tank can fail. Some older tanks are bolted or riveted in construction, but most tanks built since the 1950s are welded. Most of these tanks are not insulated or thermally protected from flame impingement.

Horizontal tanks are equipped with pressure relief devices mounted on the top of the tank. They are required to include fixed containment to hold at least the amount contained in the tank.

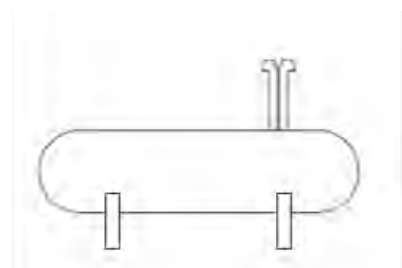

### Construction

- ▶ Horizontal tank with rounded ends
- ▶ Usually set on legs or supports
- ▶ Usually painted white or reflective color
- ▶ Pressure relief devices on top of tank
- ▶ Some residential and commercial LPG tanks are buried underground

### Contents

- ▶ Process gases
- ▶ Octane boosters
- ▶ Anhydrous ammonia
- ▶ Liquefied petroleum products (e.g., propane)

## Pressure Horizontal Tank

**These tanks store liquid petroleum gas (LPG), anhydrous ammonia and compressed or liquefied flammable gases. Pressures in the tanks range from 100 – 500 psig. These tanks have round cross-sections and rounded ends, which are characteristic of all pressure vessels.**

The quantity stored in these tanks varies from less than 1,000 gallons to over 30,000 gallons depending on the facility and type of material stored. These tanks are usually constructed of steel. Some of these tanks are insulated or thermally protected from flame impingement. Fixed water deluge systems are common in high hazard fixed facilities. They are painted white or another highly reflective color to keep heat absorption to a minimum.

**Pressure relief devices are located on top of these tanks, and can include visible stacks to direct released product above the tank shell.** Applying water to the relief valve may result in ice formation that could prevent the tank from venting. The bottom outlets are equipped with excess flow valves and back flow preventives to control the release of product if downstream lines fail.



## Spherical Tank



**Spherical tanks contain LPG, vinyl chloride, butadiene and other liquefied gases.** Pressures in these tanks range from 100 – 500 psig.

**A spherical tank is a round ball supported on vertical legs (usually thermally protected).** The quantity stored is up to 600,000 gallons, which produces a very large vapor release if this container fails.

A spherical tank shell is constructed of steel and is sometimes insulated or thermally protected. Fixed water deluge systems are very common on these tanks. They are painted white or another highly reflective color.

Pressure relief devices are located on top of these tanks, and sometimes have visible stacks to direct any released product above the tank shell. The bottom outlets are equipped with excess flow valves and back flow preventives to control the release of product if downstream lines fail.

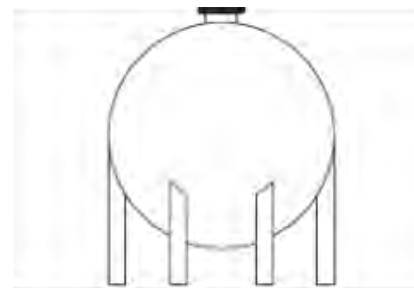

### Construction

- ▶ Ball-shaped
- ▶ Usually painted white or reflective color
- ▶ Pressure relief devices on top of tank
- ▶ Under very high pressure

### Contents

- ▶ Methane
- ▶ Propane
- ▶ LPG
- ▶ Other gases

## Cryogenic Liquid Storage Tank

**Cryogenic liquid storage tanks contain gases such as liquid oxygen (LOX), liquid nitrogen, liquid carbon dioxide and other gases like liquid hydrogen, which are super-cooled and liquefied under pressure.** Cryogenic liquid storage tanks are designed to accommodate pressures up to 250 psig. **Most cryogenic tanks are vertical and mounted on legs, but these tanks are also commonly mounted in a horizontal position, as with liquefied carbon dioxide.**

Capacity ranges from a few hundred to over 1,000 gallons at some facilities. Some low pressure cryogenic tanks designed to **contain liquefied natural gas (LNG) and anhydrous ammonia** store over two million gallons near marine and pipeline terminals. **They are designed to be a tank-within-a-tank (like a thermos bottle). They are heavily insulated so water sprayed on the tank does not affect the product temperature inside.**

These tanks are frequently found at hospitals, steel fabrication plants, large marine ports and other facilities that have a high demand for gases that are liquefied by extreme cooling.

These tanks are usually equipped with redundant safety relief devices. They are also equipped with heat exchangers to build pressure as these cold liquids evaporate. It is common to see ice on the piping under these tanks.

Due to the complicated design features of these containers, responders should seek specialist advice before attempting to operate any valves or fittings on these tanks (most of these tanks display emergency telephone numbers).

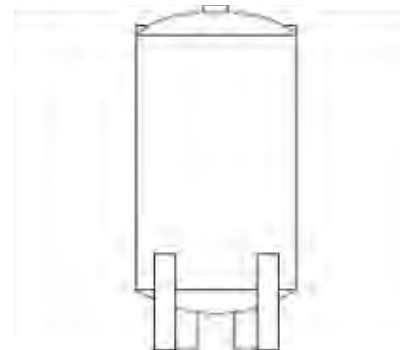

### Construction

- ▶ Vertical tank with rounded roof
- ▶ Heavily insulated
- ▶ Pressure relief devices on top of tank
- ▶ Set on legs rather than on ground

### Contents

- ▶ Liquid oxygen
- ▶ Liquid nitrogen
- ▶ Liquid carbon dioxide





Page left blank intentionally.



## Railroad Tank Cars



Railroad tank cars are bulk containers used to carry both hazardous materials and non-hazardous materials by rail. A tank's construction, as well as its size, fittings and linings, is customized to fit the demands of the materials it transports.

Although there are exceptions, **most tank cars carry only a single commodity**. In general, they all look very similar, with **circular cross-sections and semi-rounded heads**. Because they are similarly designed, many tank car characteristics need to be studied to reveal the commodity in transport.

Tank cars are categorized according to transport and product type. The most common categories are discussed in this section. Any one of these three types of containers—railroad, highway and intermodal—can transport non-pressurized, pressurized and cryogenic products. Note: Intermodal refers to containers that can be transported via more than one mode.

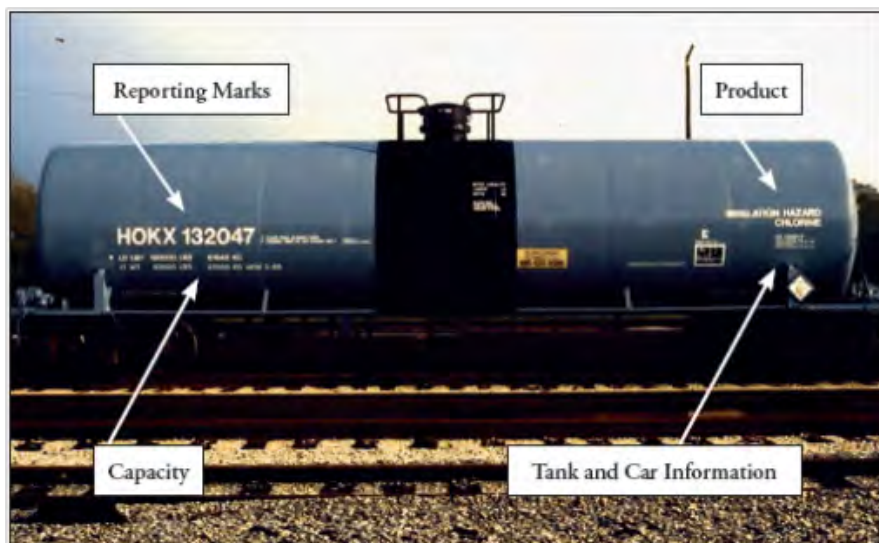

When a rail incident occurs, railroad personnel are often the best source of information to help identify any potential hazardous materials involved. They are the experts on rail car design and use, and can provide information that could save lives. First responders need to become familiar with local railroad companies before any incidents occur.

### Key Point

Non-pressure, pressure and cryogenic containers frequent all transportation routes: railways, highways and waterways.



### Low Pressure Railroad Tank Car (DOT 111)



Low pressure railroad tank cars are the most common type of tank car. **Low pressure tank cars have multiple fittings on top of the car that can be used to identify them by type.** Some older non-pressure tank cars have an expansion dome which allows for product expansion during shipment. **They transport flammable liquids, oxidizers, organic peroxides, poisons, corrosives and a variety of non-hazardous substances.**

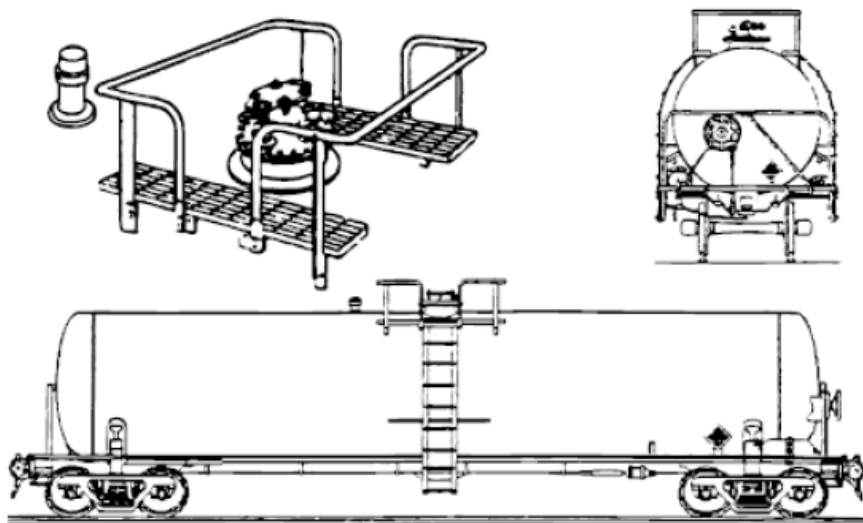

<b>Distinguishing Features</b> <ul style="list-style-type: none"> <li>• Designed for pressures below 100 psig at 105 – 115°F</li> <li>• Tank test pressures are either 60 or 100 psig</li> <li>• Capacities typically range from 4,000 – 45,000 gallons, with 25,000 gallons being most common</li> <li>• Distinguished from pressure tank cars by manway and visible fittings at top and/or bottom of tank</li> <li>• Some older non-pressure cars have an expansion dome</li> </ul>		<b>What It Transports</b> <ul style="list-style-type: none"> <li>• Flammable liquids</li> <li>• Oxidizers</li> <li>• Organic peroxides</li> <li>• Poisons</li> <li>• Corrosives</li> <li>• Also transports non-hazardous materials, such as edible and inedible animal oils, fruit and vegetable juices, tomato paste and molasses</li> </ul>
<b>Physical Form of Material Inside</b>  Liquid	<b>Physical State If Released</b>  Liquid	<b>Hazard Classes</b>  3, 4, 5, 6, 8 and 9

#### Key Point

- ▶ **Physical state** is the natural state—solid, liquid or gas—of a material.
- ▶ Some materials are transported in a different **physical form**, e.g., propane is naturally a gas but is transported as a liquefied gas.



## Corrosive Liquid Tank Cars (DOT 111)



Corrosive liquid tank cars are **non-pressure cars with fittings designed for corrosives**. Some of these cars are lined with corrosive resistant material. **Common Class 8 corrosives transported in this car are sulfuric acid, hydrochloric acid and caustic soda solution.**

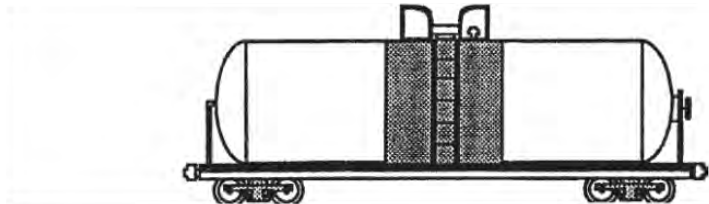

<b>Distinguishing Features</b> <ul style="list-style-type: none"> <li>• It is a non-pressure tank car in shape and design</li> <li>• Can sometimes be distinguished by staining around manway</li> <li>• Mid section may be painted with vertical stripe of corrosion-resistant paint</li> <li>• 25,000 gallon capacity</li> </ul>		<b>What It Transports</b> <ul style="list-style-type: none"> <li>• Corrosive materials (e.g., hydrofluoric acid, sulfuric acid, hydrochloric acid)</li> </ul>
<b>Physical Form of Material Inside</b> Liquid	<b>Physical State If Released</b> Liquid	<b>Hazard Classes</b> 8



### Pressure Railroad Tank Car (DOT 105/112/114)



This is the second most common type of tank car (non-pressure cars are most predominant). With rare exceptions, pressure tank cars have thermal protection jackets. **Jacketed cars can be identified by the narrow welds on the insulation jacket material.** A few sprayed-on thermal protection cars remain in service; they are recognizable by an off-white color with a rough surface finish.

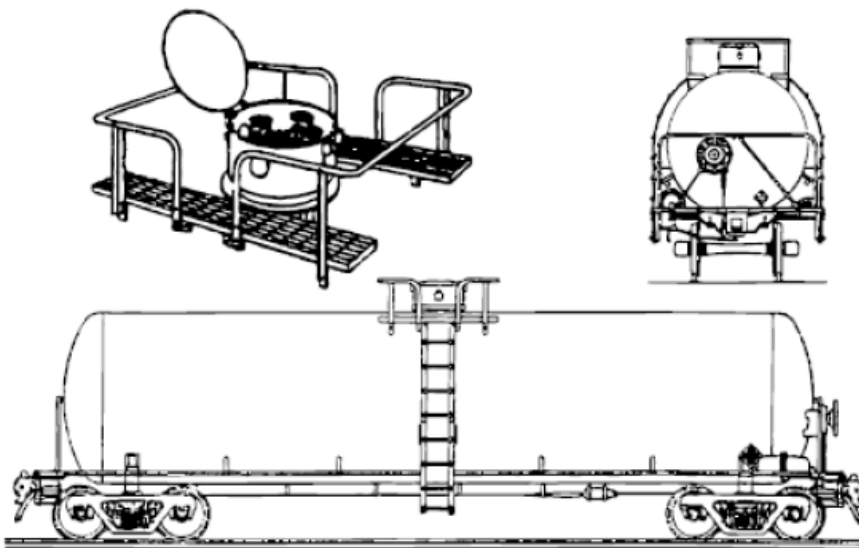

#### Distinguishing Features

- Designed for pressures from 100 – 600 psig
- Capacity is from 4,000 – 34,500 gallons, with 33,000 gallons being most common; the size of this car reflects the amount of product it can hold
- Often equipped with jacketed thermal protection
- Fittings are inside a single protective housing centered on top of tank
- Cars transporting hazardous materials are outfitted with a protective head shield
- Markings, including painted stripes, may be phased out as a homeland security measure

#### What It Transports

- Flammable and nonflammable compressed gases
- Poisonous compressed gases (e.g., propane, chlorine, anhydrous ammonia)
- Some pressure tank cars also transport high hazard or high vapor pressure Class 3 flammable liquids

#### Physical Form of Material Inside

Liquid

#### Physical State If Released

Gas or liquid

#### Hazard Classes

2.1, 2.2, 2.3, 3 and 8



## Cryogenic Liquid Railroad Tank Car (DOT 113/AAR 204)



Cryogenic liquid tank cars are comprised of a tank-within-a-tank, an alloy (stainless or nickel) steel inner tank supported by a strong outer tank. The space between the inner tank and the outer tank is filled with insulation kept under a vacuum. These cars are readily recognizable; **they have clean lines and fittings for loading and unloading that are located in the ground level cabinets at diagonal corners of the car, if not in the center of the car.**

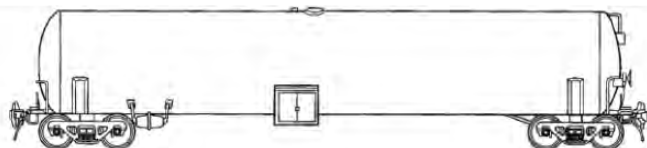

<b>Distinguishing Features</b> <ul style="list-style-type: none"> <li>• Transports low pressure (typically less than 25 psig) refrigerated (cryogenic) liquids at -130°F and below</li> <li>• Designed as an insulated tank-within-a-tank (vacuum bottle design)</li> <li>• Steel inner tank supported with a strong outer tank; space in the middle filled with insulation and kept under vacuum pressure</li> <li>• Shipments may be kept at desired temperature for up to thirty days</li> <li>• Product may vent under normal conditions</li> <li>• Since the product is very cold, applying water to the valve may freeze or block it</li> </ul>		<b>What It Transports</b> <ul style="list-style-type: none"> <li>• Liquid oxygen</li> <li>• Liquid nitrogen</li> <li>• Hydrogen</li> <li>• Argon</li> <li>• Ethylene</li> </ul>
<b>Physical Form of Material Inside</b>  Cryogenic liquid -130°F or less	<b>Physical State If Released</b>  Liquid which rapidly turns to a gas	<b>Hazard Classes</b>  2.1 and 2.2





## Trailer On Flat Car (TOFC) and Container On Flat Car (COFC)

**Flat cars are designed specifically to transport a trailer or a container.** When responders need to learn the contents of a TOFC/COFC, they must locate and look up the reporting mark and number on each individual TOFC/COFC. TOFCs and COFCs both transport the same types of hazardous materials. The running gear and wheels are permanently attached on a TOFC; they are not attached on a COFC. Portable tank COFCs can be transported intermodally. Highway cargo tanks are not, however, allowed to be carried on flat cars.

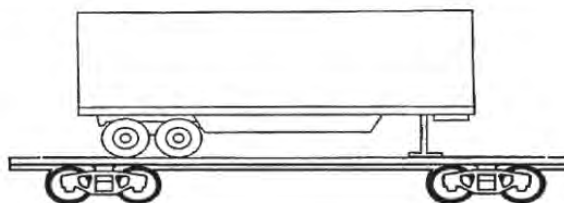

TOFC

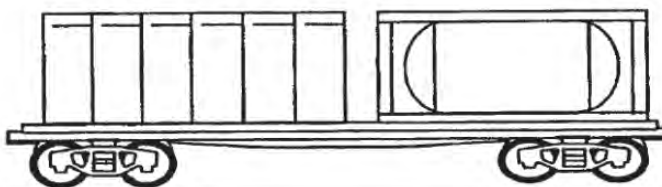

COFC

<b>Distinguishing Features</b> <ul style="list-style-type: none"> <li>• Traditional highway cargo vans (box trailer) loaded on special flatcar</li> <li>• With few exceptions, there are no Federal Railroad Administration restrictions limiting what hazard classes can be shipped in TOFCs</li> <li>• Regulations prohibit highway cargo tanks (MC/TDG) on flat cars</li> </ul>		<b>What It Transports</b>  Almost anything
<b>Physical Form of Material Inside</b>  Solid, liquid or gas	<b>Physical State If Released</b>  Solid, liquid or gas	<b>Hazard Classes</b>  All



## Gondola Railroad Car



**Gondola cars typically have low sides and no bottom outlets. They are used to transport heavy ore, scrap iron, contaminated soil, solid waste and other solid materials.**

Response agencies should be aware that these shipments may transit their jurisdictions. These cars are suitable, and commonly used, for transporting low specific activity (LSA) soil from dismantled nuclear production and processing facilities to the western states for disposal.

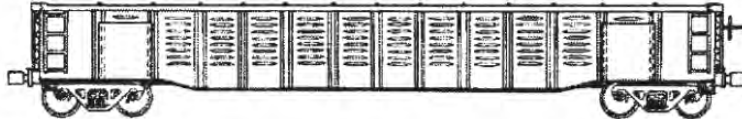

<b>Distinguishing Features</b>  <ul style="list-style-type: none"> <li>Typically uncovered, with low sides and ends</li> </ul>		<b>What It Transports</b>  <ul style="list-style-type: none"> <li>Bulk ores</li> <li>Scrap iron</li> <li>Other solid materials.</li> </ul> <p><b><u>When used to carry low specific activity (LSA) radioactive materials, these cars are covered.</u></b></p>	
<b>Physical Form of Material Inside</b>  Solid	<b>Physical State If Released</b>  Solid	<b>Hazard Classes</b>  4 and 7	



## Pneumatically Unloaded Railroad Hopper Car



**Pneumatically unloaded hopper cars do not always have a round cross-section. Some are semi-circular.** Regardless of cross-section shape, these cars operate similarly. **Closed hopper cars designed to carry grain have mechanical hatches on the bottom of the car and are unloaded through the force of gravity.**

**Plastic pelletized materials** are frequently transported in closed hopper cars. Some of these plastics go through a curing process in which they give off flammable gases that have accumulated in the upper portion of the car. Historically, flash fires have occurred when the manways of these cars were opened and static discharges ignited these vapors, subsequently injuring facility personnel and increasing responder risk.

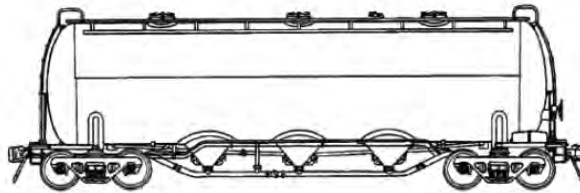

<b>Distinguishing Features</b> <ul style="list-style-type: none"> <li>• Test pressures range from 140–550 kPa (20–80 psig)</li> <li>• Designed to carry dry commodities</li> <li>• They are unloaded by applying air or an inert gas</li> </ul>		<b>What It Transports</b> <ul style="list-style-type: none"> <li>• Dry caustic soda</li> <li>• Grain</li> <li>• Plastic pellets</li> <li>• Coal</li> <li>• Wood chips</li> </ul>
<b>Physical Form of Material Inside</b>  Solid	<b>Physical State If Released</b>  Solid	<b>Hazard Classes</b>  4, 5, 6, 8 and 9



## Highway Cargo Tanks

Highway shipments of hazardous materials originate from virtually every community. The shape and features of a cargo tank provide clues to some of the basic characteristics and inherent dangers of products transported in the container (how they will behave if accidentally released or caught on fire). The ERG drawings of cargo tankers can be used along with the relevant guide page to plan a response.

Virtually all hazardous materials are transported in one of four cargo tank types:

- Non-Pressure
- Low Pressure
- Pressure
- Corrosive

Non-pressure cargo tanks comprise 57% of the containers in trucks on the road. Being frequently on the highways, most hazardous materials incidents involve products transported on trucks of this type.

## Proportion of Highway Cargo Tanks by Type

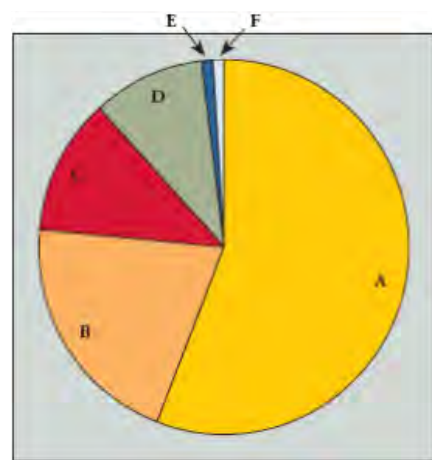

A. Non-Pressure	57%
B. Low Pressure	21%
C. Corrosive	12%
d. Pressure	10%
e. Cryogenic	< 1%
f. Tube	< 1%

Source: Office of Hazardous Materials Safety, Research and Special Programs Administration, U.S. Department of Transportation.



During fires, these aluminum shell tanks will melt down to the level of the liquid in the compartment. (Aluminium melts at 1,220°F.) Responders approaching burning tanks in the wheels up position should use extreme caution; as the tank shell becomes weak, the compartment can compress, fail and rapidly spread fire.

### Non-Pressure Liquid Tank DOT406, TC406, SCT-306 (MC306/TC406)



This type of cargo tank is used for more hazardous materials shipments than any other cargo tank. These tanks usually have five compartments with internal baffles. Some tanks have single bulkheads between compartments while others have double bulkheads. These cargo tanks are bottom loaded. The piping to each compartment is wet (filled with product) and can hold as much as 50 gallons of product until the compartment is unloaded.

Although most of these tanks have elliptical cross sections, those used to haul crude oil have round cross sections. These tanks sometimes have visible external stiffening rings. This cargo tank is equipped with spring loaded pressure/vacuum (PV) valves. Internal valves located on the bottom of each compartment are spring loaded and have a shear section designed to break away in a collision and maintain the product inside the tank.

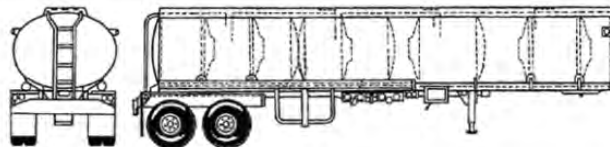

Distinguishing Features		What It Transports
<ul style="list-style-type: none"> <li>• Operating pressure of 4 psig or less</li> <li>• Up to 12,000 gallon capacity</li> <li>• Elliptical cross-sections and flat ends</li> <li>• Usually compartmented, each compartment having its own manhole assembly</li> <li>• Number of discharge valves beneath the tank indicates number of compartments</li> <li>• Have rollover protection running the length of the tank (called a catwalk)</li> <li>• May be permanently marked with owner's name and/or type of material being transported</li> <li>• Remote shut-off located behind the driver on the front left side of a trailer (some carriers also have a remote shut-off on the right rear of the trailer)</li> <li>• May carry different products in different compartments</li> </ul>		Transports petroleum products such as: <ul style="list-style-type: none"> <li>• Gasoline</li> <li>• Fuel oil</li> <li>• Solvents</li> <li>• Non-hazardous products</li> </ul>
Physical Form of Material Inside	Physical State If Released	Hazard Classes
Liquid	Liquid	3



## Low Pressure Highway Chemical Tank DOT407, TC407, SCT-307(MC307 or TC407)



Low pressure cargo tanks account for 21% of the fleet of all highway cargo tanks. These cargo tanks are sometimes called the work horse of the chemical industry. These cargo tanks may be either top or bottom loaded. Responders should be aware that product could be trapped under the body discharge piping. A remote emergency shut-off is located on the left front of the trailer.

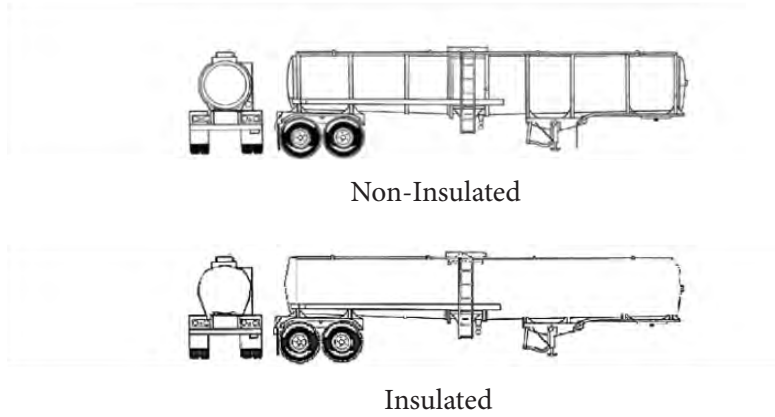

### Additional Information

- ▶ The shape may vary from a round cross-section with visible stiffening rings for tanks that are not insulated, to a horseshoe shape for cargo tanks that are insulated.
- ▶ Insulated (horseshoe shaped) tanks are more common than tanks that are not.
- ▶ Some of these tanks may slant downward to the center for more efficient off-loading of product.
- ▶ Usually constructed of stainless steel, but regulations permit aluminum and mild steel.
- ▶ Stainless steel is harder than aluminum or mild steel and is more brittle, so when heated will lose its integrity much faster than mild steel.
- ▶ These tanks are usually equipped with spring loaded pressure/vacuum (PV) valves to prevent tank failure.
- ▶ Many of these tanks have fusible (venting) clean-out caps on each compartment.
- ▶ Specifications for this cargo tank include MC307 (old specification) and TC407 (new specification).
- ▶ The TC407 may be air-pressurized to expedite off-loading.

Distinguishing Features		What It Transports
<ul style="list-style-type: none"> <li>• Operating pressure of 25 – 35 psig</li> <li>• 6,000–7,000 gallon capacity</li> <li>• Circular or horseshoe shaped cross-sections and flat ends</li> <li>• One or two compartments are most common</li> <li>• Insulation is common on this type of cargo tank: if a tank is insulated, it may appear (from behind) to have a horseshoe-shaped cross-section</li> <li>• May have rollover protection extending from front to back of tank</li> <li>• Remote shut-off located behind driver on left side of trailer</li> <li>• These cargo tanks have a pressure/vacuum relief device; the devices vary based on design</li> </ul>		<ul style="list-style-type: none"> <li>• Flammable and combustible liquids (e.g., xylene and toluene)</li> <li>• Mild corrosives (caustic soda solution)</li> <li>• Poisons (epichlorohydrin)</li> <li>• A wide variety of Class 9 hazardous waste</li> <li>• Almost all other types of liquid chemicals</li> </ul>
Physical Form of Material Inside	Physical State If Released	Hazard Classes
Liquid	Liquid	3, 5.1, 5.2, 6, 8 and 9 Also non-hazardous products





### Additional Information

- ▶ Corrosive liquid tanks account for 12% of the nation's cargo tank fleet.
- ▶ Most of these tanks do not have bottom outlet valves. They are either top loaded and gravity unloaded, or loaded and unloaded pneumatically, using air or inert gas pressure to push the product.
- ▶ Specifications for this cargo tank include MC312 (old specification) and TC412 (new specification).

## Corrosive Liquid Tank DOT412, TC412, SCT-312 (MC312 / TC412)



Most corrosive liquid tanks are built of mild steel and stainless steel. Some of these tanks are lined with rubber and other coatings to prevent corrosion of the tank shell. These tanks are typically single shell without internal baffles. Most have visible stiffening rings running vertically around the tank (stiffening rings may not be visible on insulated tanks). These tanks have circular cross-sections and flat ends; the tanker may appear horseshoe-shaped if insulated.

Although these tanks have the same basic configuration as the low pressure cargo tank, they are smaller in diameter. These tanks are built relatively small to keep the overall weight as low as possible, given the heavy liquids that they transport, as much as 20 pounds/gallon. Some of these tanks are insulated and jacketed. And, like the low pressure cargo tank, they have a horseshoe-shaped cross-section.



Distinguishing Features		What It Transports
<ul style="list-style-type: none"> <li>• Operating pressure of 75 psig</li> <li>• 5,000 – 6,000 gallon capacity depending on the density of the product</li> <li>• Same basic configuration as low pressure cargo tanks</li> <li>• Circular cross-sections and flat ends; tanker may appear horseshoe-shaped if insulated</li> <li>• Relatively smaller diameter than other cargo tanks because they transport dense products</li> <li>• Have rollover protection across the top of the container, and may be equipped with splash protection (a spill box)</li> <li>• Because of corrosive cargo, are often discolored from splashed product</li> <li>• Some vacuum trucks are built to this specification</li> <li>• Remote shut-off located behind driver on left side of trailer</li> </ul>		<ul style="list-style-type: none"> <li>• Corrosives such as caustic soda, hydrochloric acid, sulfuric acid, nitric acid and hazardous waste</li> <li>• Other high-density, non-hazardous liquids</li> <li>• Hydrogen peroxide is a common Class 5 product.</li> <li>• Because vacuum trucks are also built to this specification, they can transport hazardous wastes as well.</li> </ul>
Physical Form of Material Inside	Physical State If Released	Hazard Classes
Liquid	Liquid	3, 5, 6, 8 and 9 Also non-hazardous products



## High Pressure Tank MC331, TC331, SCT-331



High pressure tanks account for 10% of the nation's cargo tanks. These tanks are designed to contain pressures required to maintain products in a liquid state (e.g., propane, anhydrous ammonia). Most of these tanks are made of steel that is post-weld heat-treated to add strength. Tank shell thickness can be up to 0.375 inches and heads can be up to 0.250 inches.

These tanks typically have two spring loaded pressure relief valves on top. In addition, the loading and unloading valves are protected with fusible links and excess flow valves to prevent uncontrolled release of product.

This is the highway cargo tank commonly associated with the potential for BLEVE.

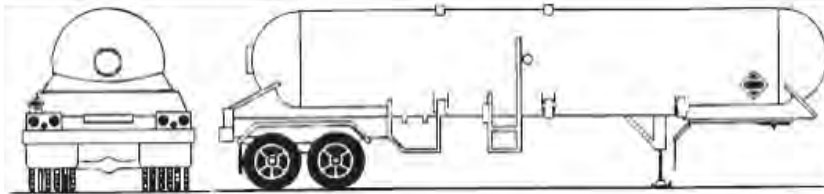

### Additional Information

- ▶ A smaller version of this tank, called a bob tail, is common in rural areas for the delivery of propane and anhydrous ammonia.
- ▶ In some parts of the country, high vapor pressure flammable and toxic/corrosive liquids are transported in these cargo tanks, warranting Class 3, 4, 6 or 8 placards.
- ▶ Cryogenic liquids like oxygen, nitrogen and helium may be transported in insulated pressure cargo tanks.
- ▶ Carbon dioxide, a refrigerated liquid that can pose problems, falls short of the cryogenic definition, so is routinely transported in insulated pressure cargo tanks.
- ▶ Specifications for this cargo tank include MC 330 and MC 331 (specifications for this cargo tank did not change in 1993 as many of the others did).

<b>Distinguishing Features</b> <ul style="list-style-type: none"> <li>• Designed to contain pressures of from 100 – 500 psig and carry products with very high expansion ratios:                             <ul style="list-style-type: none"> <li>▫ Propane = 270 times</li> <li>▫ Chlorine = 460 times</li> </ul> </li> <li>• 11,500 gallon capacity</li> <li>• Have rounded cross-section and heads</li> <li>• In some instances, insulation is used on these tanks</li> <li>• Top two-thirds of the tank is highly reflective or painted white</li> <li>• Remote shut-off located behind driver on left side or right rear of trailer</li> <li>• Some have a protective housing similar to a pressure railcar</li> </ul>		<b>What It Transports</b> <ul style="list-style-type: none"> <li>• Gases liquefied through compression (e.g., propane, butane, butadiene, anhydrous ammonia, chlorine, carbon dioxide)</li> <li>• High vapor pressure flammable liquids and aluminum alkyls</li> <li>• Anhydrous hydrogen fluoride</li> <li>• Cryogenic liquids</li> </ul>
<b>Physical Form of Material Inside</b> Liquefied compressed gas or liquid	<b>Physical State If Released</b> Gas or liquid	<b>Hazard Classes</b> 2.1, 2.2, 2.3, 3, 4.2, 4.3, 6.1 and 8



### Cryogenic Liquid Highway Cargo Tank MC338, TC338, SCT-338 (TC341, CGA341)



Cryogenic cargo tanks make up only a small portion of the cargo tank fleet. Most of these tanks are made of steel, with heavy insulation under a vacuum. They are designed to act like a very large thermos bottle—keeping the extremely cold liquids at their intended temperature for an extended period of time. As the product in the tank cools, low pressure venting normally appears as it escapes from the road-relief valve on the rear of the trailer. Products like liquid oxygen and nitrogen vent under normal conditions.

These are very specialized cargo tanks and may require manufacturer advice during an emergency. One specification for this cargo tank is MC 338, although there are others.

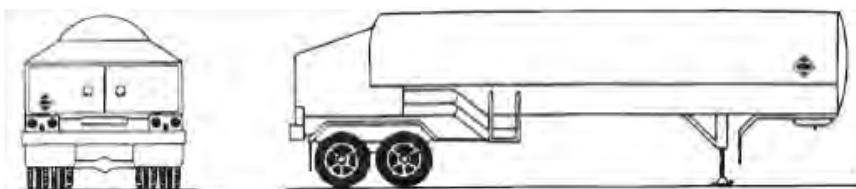

<b>Distinguishing Features</b> <ul style="list-style-type: none"> <li>• Operating pressure of 25 – 500 psig</li> <li>• Capacity up to 8,000 gallons</li> <li>• Vapors discharge from relief valves; visible venting from road relief valve is normal</li> <li>• Circular cross-sections and rounded ends</li> <li>• Tank within a tank, similar to a large vacuum bottle</li> <li>• Heavily insulated with piping and valves typically found in a rear cabinet</li> <li>• Some of these cargo tanks have valve cabinets or a dog house on the rear of the tank.</li> <li>• These tanks have redundant relief devices and an emergency shut-off in the valve cabinet.</li> <li>• Remote shut-off located behind driver on left side of trailer</li> </ul>		<b>What It Transports</b> <ul style="list-style-type: none"> <li>• Gases liquefied through temperature reduction (e.g., liquid oxygen, nitrogen, hydrogen, helium)</li> </ul>
<b>Physical Form of Material Inside</b> Extremely cold liquid (minimum of -130°F, according to DOT's definition)	<b>Physical State If Released</b> Extremely cold liquid that quickly becomes a gas	<b>Hazard Classes</b> 2.1, 2.2 and 2.3



## Compressed Gas/Tube Trailer



Compressed gas/tube trailers account for only a small percentage of highway transportation. Cylinders are seamless steel, and each cylinder has its own relief device—usually a rupture (burst) disc. The cylinders work in tandem like a breathing air cascade system. Transport Canada (TC) does not class tube trailers as cargo tanks. The TC specifications for the individual cylinders are 3A, 3AA, 3AX, 3AAX and 3T.

These trailers are designed to transport gases under pressure, such as oxygen, nitrogen, ethane, ethylene, methane and hydrogen chloride. They do not transport liquefied gases. All cylinders carry the same gas. All cylinders are cascaded together to a single discharge manifold. Cylinders range from 9 – 24 inches in diameter. Their distinct design makes them easily distinguishable from other cargo tankers.

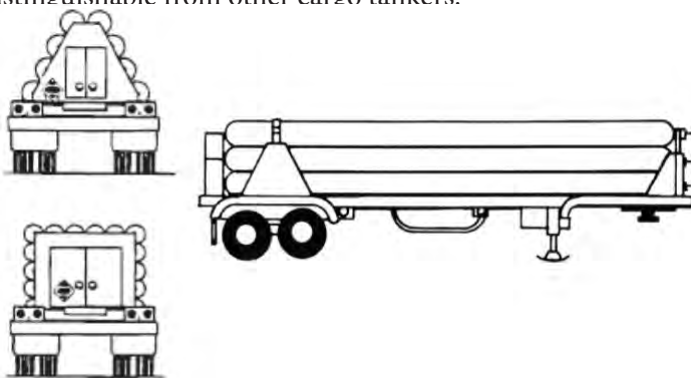

Distinguishing Features		What It Transports
<ul style="list-style-type: none"> <li>• Operating pressure of 3,000 – 5,000 psig</li> <li>• Cylinders usually have a minimum water capacity of 1,000 lbs</li> <li>• Protected valves in rear</li> <li>• Unique design makes them easily distinguishable</li> <li>• Modified semi-trailers with long, thin cylinders or tubes that are connected together and permanently mounted on a semi-trailer</li> <li>• Each cylinder is independently piped and valved</li> <li>• All cylinders contain the same compressed gas</li> </ul>		<ul style="list-style-type: none"> <li>• Non-liquefied gases under pressure: argon, carbon dioxide, helium, hydrogen, nitrogen, oxygen and refrigerant gases (e.g., freons)</li> </ul>
Physical Form of Material Inside	Physical State If Released	Hazard Classes
Gas	Gas	2.1, 2.2 and 2.3



### Additional Information

- ▶ Most of these tanks do not have any residual pressure during transit because they are full.
- ▶ Air or inert gas pressure is used to load and unload product from these tanks.
- ▶ Can hold several thousand pounds of product, depending on the product density.

## Non-Specification Cargo Tanks – Dry Bulk Cargo Tanks



Dry bulk cargo tanks account for a small percentage of the total fleet. Tank may be constructed of steel, stainless steel or aluminum. These tanks transport solids or slurries, so they can be very heavy loads. Loads may shift, so caution should be exercised when standing by during transfer and while up-righting.

Large static charges can build up when products are transferred through hoses. Uncured plastic pellets have the tendency to give off flammable gas. Such built-up gas vapors could ignite with a static discharge or other ignition source.

These cargo tanks are described as non-specification because they do not rise all the way up to Transportation Canada requirements for cargo tanks; however, they are sufficiently strong to withhold working pressures of 20 – 80 psig. When used to transport hazardous materials, they are required to be placarded.

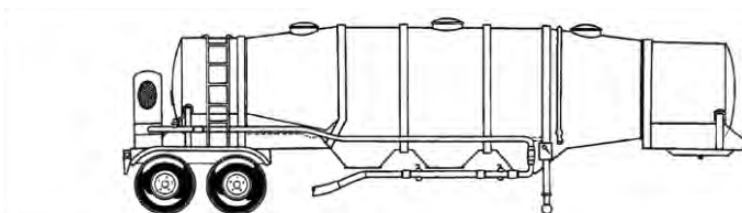

<b>Distinguishing Features</b> <ul style="list-style-type: none"> <li>• Working pressure of 20 – 80 psig</li> <li>• Have a round to V-shaped cross section</li> <li>• Large, heavy, sloping W-shaped unloading compartments are located at the bottom of the trailer</li> <li>• Some have a rear-mounted air compressor</li> <li>• Pneumatically unloaded</li> </ul>		<b>What It Transports</b> <ul style="list-style-type: none"> <li>• Dry materials such as fertilizers, oxidizers and plastic pellets</li> <li>• Some materials may be water reactive</li> </ul>
<b>Physical Form of Material Inside</b>  Solid or slurry	<b>Physical State If Released</b>  Solid or slurry	<b>Hazard Classes</b>  5.1 and 9



## Non-Specification Highway Cargo Tanks – Molten Sulfur Tank



Molten sulfur cargo tanks are not TC regulated tanks. These tanks are sometimes referred to as **non-spec cargo tanks**. The term non-spec does not mean that the tank is not a quality container.

Whereas most hazardous materials need to be transported in specification tanks, non-specification tanks are sufficient for certain products, such as molten sulfur—a Class 9, UN material ID 2448. The trailer will be placarded and stenciled: Molten Sulfur UN 2448.

This tank resembles an insulated low pressure cargo tank. It is common to see a bright yellow sulfur residue spilled around the manway in the center of the tank. These tanks are heavily insulated to maintain product temperatures of about 325°F. Steam coils are located inside the tank to maintain temperature while the load is in transit.

Some of these trailers are equipped with a large breathing air cylinder located near the ladder at the center of the trailer. Some facilities require personnel loading and unloading molten sulfur trailers to wear a supplied air breathing apparatus to guard against inhaling sulfur dioxide and hydrogen sulfide.

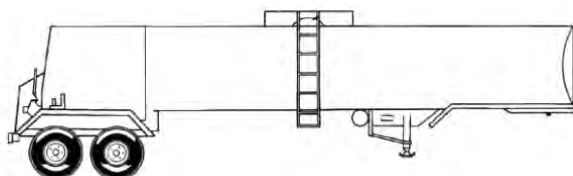

### Additional Information

Hazards for fire fighting include risk of slop-over if water gets inside container.

Distinguishing Features		What It Transports
<ul style="list-style-type: none"> <li>Looks similar to an insulated low pressure cargo tank</li> <li>Tank is heavily insulated to retain the heat of the product</li> <li>Steam coils are mounted inside the shell so that sulfur stays molten</li> <li>May have a high pressure breathing air cylinder mounted on the bottom of the trailer near the ladder</li> </ul>		Molten sulfur
Physical Form of Material Inside	Physical State If Released	Hazard Classes
Extremely hot liquid, about 325°F	Extremely hot liquid	9





### Additional Information

**Responders be aware:** a mixture of asphalt plus a flammable or combustible liquid in its hot state (asphalt cutback) could readily burn if released from the tank.

### Non-Specification Cargo Tanks: Asphalt Trailer



Asphalt trailers are not TC regulated tanks. These tanks are sometimes referred to as **non-spec cargo tanks**. The term non-spec does not mean that the tank is inferior in quality. Hot asphalt does not require containment in a specification tank, as do many other hazardous materials. A non-specification tank is ideally suited to transport hot asphalt.

This tank resembles both the insulated low pressure as well as the non-pressure cargo tank. Spilled black residue typically appears around the manway in the center of the tank and near the unloading valves on the rear of the trailer.

These tanks are heavily insulated to maintain product temperatures during transit. There are no steam coils inside these tanks, but some asphalt trailers have burner tubes and may carry propane bottles to fuel the burners.

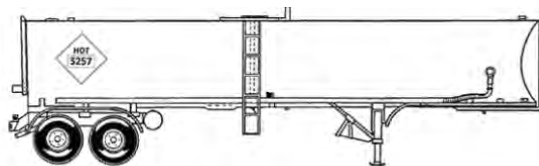

<b>Distinguishing Features</b> <ul style="list-style-type: none"> <li>• Looks similar to non-pressure or insulated low pressure cargo tank</li> <li>• Tank is heavily insulated to retain the heat of the product</li> <li>• These tanks are usually stenciled and placarded: Hot UN 3257</li> <li>• May have burner tubes and carry propane bottles to fuel burners</li> </ul>		<b>What It Transports</b> <ul style="list-style-type: none"> <li>• Asphalt or asphalt cutback (flammable or combustible)</li> </ul>
<b>Physical Form of Material Inside</b>  Extremely hot liquid that could be combustible	<b>Physical State If Released</b>  Extremely hot liquid that could be combustible	<b>Hazard Classes</b>  9



## Intermodal Tank Containers (IMs)



Intermodal tank containers consist of a single metal tank mounted inside a sturdy metal supporting frame. This unique frame structure enables their transport via more than one mode (rail, highway, water).

The tank is generally built as a cylindrical tank enclosed within a steel frame. Its capacity is generally about 6,340 gallons. Other tank shapes and configurations are rare, as are tanks with multiple compartments.

Over 90% of all tank containers are non-pressure intermodal tank containers. They generally transport liquid materials at **Maximum Allowable Working Pressures (MAWP)** of up to 100 psig. Tanks are tested to at least 1½ times the MAWP.



### Additional Information

Intermodal means interchangeable between transportation modes. These containers can be transported by train along railways, then moved onto a truck for transport across highways, then loaded onto a ship to be carried across the ocean.

#### The United States Serves as a "Land Bridge"

Containers of hazardous materials can circle the world by passing through the United States, without necessarily being unloaded. Product can be moved off of a ship, loaded onto a rail or highway carrier, then reloaded back onto another ship during transport.



### Additional Information

Specification plates are located on the discharge end of the container. These plates contain details about the container's specification number and construction. The international specification markings on tank containers are in accordance with the International Maritime Organization (IMO). Reporting marks and numbers similar to those found on railcars are located on the right side of the container and on the top of the frame.

## IM 101 Non-Pressure Tank Container (IMO Type 1) IM 102 Non-Pressure Tank Container (IMO Type 2)

Non-pressure tank containers make up the majority of all tank containers. Most tank containers are single compartment without baffles. A minimum amount of outage is maintained to allow for product expansion and to minimize the movement.

The tank is equipped with pressure vacuum vents (PV) similar to those found on low pressure cargo tanks. The tank container can be shipped in almost any mode of transportation, but is commonly shipped by rail and highway service.

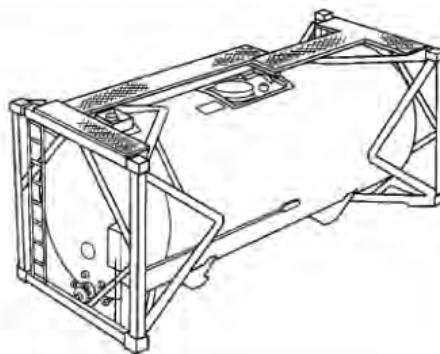

<b>Distinguishing Features</b> <ul style="list-style-type: none"> <li>Working pressures: <ul style="list-style-type: none"> <li>IM 101 from 25.4 – 100 psig</li> <li>IM 102 from 14.5 – 25.4 psig</li> </ul> </li> <li>Capacity will not exceed 6,300 gallons</li> <li>Tank is permanently mounted in a steel frame</li> <li>Designed like a low pressure highway cargo tank, without wheels</li> <li>Built to rigid international specifications</li> <li>Insulated tanks are very common</li> <li>Emergency shut-off is located on the right side of the container, when facing the discharge valve end of the container</li> </ul>		<b>What It Transports</b> <ul style="list-style-type: none"> <li>Both hazardous and non-hazardous products (e.g., acetone, hydrogen peroxide, methyl ethyl ketone peroxide (MEKP)) <ul style="list-style-type: none"> <li>Toxic materials</li> <li>Corrosives</li> <li>Flammables</li> <li>Fertilizers and pesticides</li> <li>Food grade products like beer and whiskey</li> </ul> </li> </ul>
<b>Physical Form of Material Inside</b>  Liquid	<b>Physical State If Released</b>  Liquid	<b>Hazard Classes</b>  3, 5.1, 5.2, 6, 8 and 9



## Pressure Tank Container DOT Spec. 51 (IMO Type 5)

Pressure tank containers account for only a small percentage of the total fleet of intermodal tank containers. They are equipped with spring-loaded safety relief valves similar to those found on pressure tank cars and highway cargo tanks. Loading/unloading valves consist of vapor and liquid lines.

Specification plates are located on the discharge end of the container. These plates contain details about the containers specification number and construction. Reporting marks and numbers similar to those found on railcars are located on the right side of the container and on the top of the frame.

It is designed like a high pressure highway cargo tank, without wheels, and transports liquefied gases and high vapor pressure liquids like propane, anhydrous ammonia, methyl bromide and aluminum alkyls. It is constructed of steel and may be insulated. The remote shut-off is located near the loading/unloading valves.

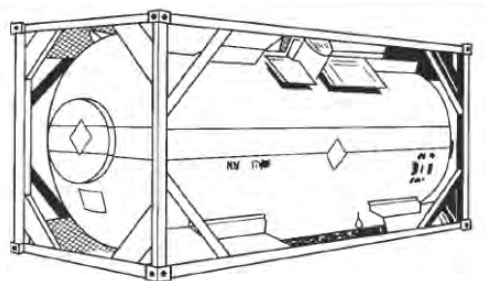

<b>Distinguishing Features</b> <ul style="list-style-type: none"> <li>• Working pressures of 100 – 500 psig</li> <li>• Capacity up to 5,500 gallons</li> <li>• Designed like a high pressure highway cargo tank without wheels</li> <li>• Built to rigid international specifications</li> <li>• Tank is permanently mounted in a steel frame</li> <li>• Containers can be either insulated or non-insulated</li> <li>• Location of emergency shut-off is determined by the design of the container</li> </ul>		<b>What It Transports</b> <ul style="list-style-type: none"> <li>• Liquids or gases liquefied under pressure</li> <li>• Liquefied gases like propane, anhydrous ammonia, methyl bromide</li> <li>• Liquids like motor fuel antiknock compound and aluminum alkyls</li> </ul>	
<b>Physical Form of Material Inside</b>  Liquefied gas or liquid	<b>Physical State If Released</b>  Liquid or gas	<b>Hazard Classes</b>  2.1, 2.2, 2.3, 3, 4.2, 4.3, 6, 8 and 9	



### Cryogenic Tank Container – DOT Spec 51L (IMO Type 7)

Cryogenic tank containers account for only a small percentage of all intermodal tank containers. These containers are constructed to serve as a tank-within-a-tank vacuum bottle. Most of these containers are equipped with coils that act as heat exchangers to produce pressure for unloading product.

Specification plates are located on the discharge end of the container. These plates include the container’s specification number and type of construction. Reporting marks and numbers similar to those found on railcars are located on the right side of the container and on the top of the frame.

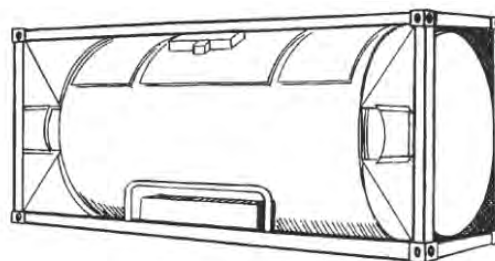

<b>Distinguishing Features</b> <ul style="list-style-type: none"> <li>• Working pressures of 25 psig or less</li> <li>• Capacity up to 5,000 gallons</li> <li>• Designed like a cryogenic highway cargo tank, without wheels</li> <li>• Built to rigid international specifications</li> <li>• Tank is mounted in a steel frame</li> <li>• Tank-within-a-tank design (vacuum bottle)</li> <li>• Location of emergency shut-off is determined by the design of the container</li> </ul>		<b>What It Transports</b> <ul style="list-style-type: none"> <li>• Gases liquefied by extreme cold &lt; -130°F, by DOT’s definition): oxygen, argon, nitrogen, ethylene and hydrogen</li> </ul>
<b>Physical Form of Material Inside</b>  Extremely cold liquid	<b>Physical State If Released</b>  Extremely cold liquid that rapidly gases off	<b>Hazard Classes</b>  2.1, 2.2, 2.3, 6, 8 and 9



## Intermodal Tube Module

Tube modules account for a very small percentage of all intermodal containers. The number of tubes and capacity of a tube module will vary with its design and product. Typically, intermodal tube modules have fewer cylinders than the corresponding highway tube trailer.

The compressed gas tubes in these modules are built to rigid international standards. Tube modules operate as a cascade system (similar to breathing air refill systems).

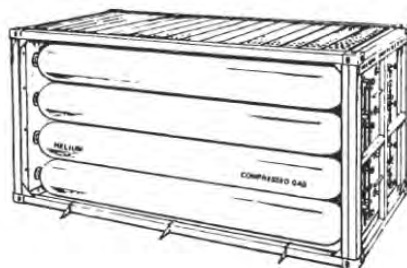

<b>Distinguishing Features</b> <ul style="list-style-type: none"> <li>• High pressures of 3,000 – 5,000 psig</li> <li>• Designed like a highway tube trailer without wheels</li> <li>• Built to rigid international specifications</li> <li>• Tank is mounted in a steel frame</li> <li>• Each cylinder is independently piped and valved with a pressure relief device and product control valve</li> <li>• All cylinders contain the same compressed gas</li> <li>• System operates in cascade (similar to breathing air refill systems)</li> </ul>		<b>What It Transports</b> <ul style="list-style-type: none"> <li>• Non-liquefied gases under pressure:                         <ul style="list-style-type: none"> <li>▫ Argon</li> <li>▫ Carbon dioxide</li> <li>▫ Helium</li> <li>▫ Hydrogen</li> <li>▫ Nitrogen</li> <li>▫ Oxygen</li> <li>▫ Refrigerant gases (e.g., freons)</li> </ul> </li> </ul>
<b>Physical Form of Material Inside</b>  Gas	<b>Physical State If Released</b>  Gas	<b>Hazard Classes</b>  2.1, 2.2 and 2.3





## Intermediate Bulk Containers (IBCs) – Super Sacks and Totes

Intermediate bulk containers are rigid or flexible portable packaging (other than cylinders or portable tanks) designed for mechanical handling. These containers, intended to replace steel and plastic drums, are typically dedicated to single product use so they can be recycled. They may be as large as 3½ – 4 feet wide and tall. They are used to transport greater quantities of the same materials that are usually stored in drums.

Totes come in many different sizes and shapes. Some are constructed of steel or stainless steel; others are made of plastic (which is sometimes dropped into a steel cage). Totes are designed to transport any class of hazardous materials non-hazardous materials that might otherwise be transported in steel or poly drums.



Intermediate Bulk Container:  
Super Sack



Intermediate Bulk Containers:  
Totes



## Portable Tanks

Portable tanks usually have a circular cross-section. They are equipped with skids or frames to facilitate handling and may be shipped in every mode of transportation. They transport both hazardous and non-hazardous liquids, including corrosives, flammables, toxics, food grade commodities, whiskey and liquid fertilizer.



Vertical Portable Tank



Horizontal Portable Tank



Horizontal Portable Tank



## One-Ton Containers

One-ton containers are cylindrical in shape with concave heads welded to the cylinder. They range in liquid capacity from 180 – 320 gallons. Tank test pressures range from 500 – 1,000 psig.

When shipped by rail, one-ton containers are carried:

- On special flat cars
- In box cars or gondola cars
- In trailer-on-flat-cars or container-on-flat-cars

All fittings are located in the heads, including fusible plugs. Safety relief devices are prohibited for certain poisonous or noxious materials.

One-ton containers transport gases such as:

- Chlorine (most common)
- Butadiene
- Anhydrous ammonia
- Phosgene
- Sulfur dioxide
- Refrigerant or dispersant gases

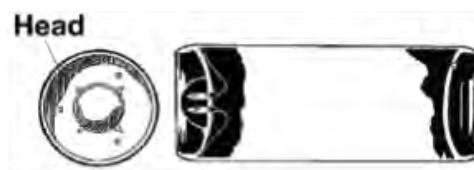

One ton containers are cylindrical in shape with concave heads welded to the tank shell.



First responders should know where chlorine kits are located in their jurisdictions, and who is qualified to use the kits during an emergency.



## Non-Bulk Containers

Containers are classified as non-bulk when their capacities are less than the following quantities:

- 119 gallons for liquid
- 882 pounds for net solids
- Water capacity of 1,000 pounds for gas

The contents of non-bulk containers is hard to determine solely on the basis of shape and design of the container. Non-bulk packaging for hazardous (as well as non-hazardous) materials includes:

- Drums
- Bottles
- Bags
- Multi-cell packages
- Fiberboard and wooden boxes
- Dewars
- Carboys
- Cylinders

These containers are everywhere—around warehouses, retail outlets and homes, in boxcars, cargo vans and semi-trailers. Contents of such containers are hard to identify at a distance. In most cases, first responders have to rely on proper markings and shipping papers to determine whether the contents could potentially be hazardous.

When labels and other markings are missing or not legible on these containers, the chart on the following pages can serve as a reference to determine possible contents.





### Drums (Including Pails)



#### Construction

- Metal
- Fiberboard
- Plastic

#### Contents

Drums may contain almost any form of hazardous material, including powders, liquids, pastes and slurries

### Bottles and Jars



#### Construction

- Glass
- Plastic
- Occasionally made of ceramic or metal

#### Contents

Liquid and solid hazardous and non-hazardous materials

### Bags



#### Construction

- Plastic
- Paper

#### Contents

Liquid and solid hazardous and non-hazardous materials

- Dry corrosives
- Explosives
- Flammable solids
- Oxidizers
- Poisons



### Multi-Cell Packages

	<p><b>Construction</b></p> <ul style="list-style-type: none"> <li>• Polystyrene or fiber-board fitted form containers</li> <li>• Boxes must be designed to provide a snug fit to contents</li> </ul>	<p><b>Contents</b></p> <ul style="list-style-type: none"> <li>• Corrosives</li> <li>• Flammables</li> <li>• Poisons</li> <li>• Oxidizers</li> </ul>
--	--	---

### Boxes

	<p><b>Construction</b></p> <ul style="list-style-type: none"> <li>• Wood</li> <li>• Fiberboard</li> </ul>	<p><b>Contents</b></p> <p>Most types of hazardous materials</p>
--	---	---

### Carboys

<p>3 Gallon      5 Gallon</p> <p>6 Gallon      6.5 Gallon</p>	<p><b>Construction</b></p> <ul style="list-style-type: none"> <li>• Glass</li> <li>• Plastic</li> <li>• Encased in specially cushioned boxes made of either wood or cardboard</li> </ul>	<p><b>Contents</b></p> <ul style="list-style-type: none"> <li>• Corrosive liquids</li> <li>• Flammable liquids</li> <li>• Poison or toxic liquids</li> </ul>
---	--	--





### Dewars



#### Construction

- Non-pressurized, heavily insulated containers
- Usually with a vacuum space between the inner and outer shells (this is sometimes called a jacketed-vacuum)

#### Contents

Cryogenic materials such as liquefied nitrogen, oxygen and helium

### Cylinders



#### Construction

- Short, broad cylinders are generally used for low pressure materials
- Tall, thin cylinders are usually used for high pressure materials
- Note: not color-coded

#### Contents

- Compressed gases
- Liquefied gases
- Flammables
- Toxics
- Radioactive materials
- Corrosives



## Radioactive Materials Packaging

These containers may be made from a variety of materials, depending on the level of radioactivity of the contents. Low level radioactive materials may be packaged in glass bottles that are further packed in cardboard, fiberboard, wooden boxes or steel drums. Higher level radioactive materials (such as spent nuclear fuel) require more secure packaging, such as steel containers lined with lead or depleted uranium. These large cylindrical casks may be surrounded by reinforcing rings.

In general, containers for radioactive materials are distinctive because they are:

- Bulkier than other packages of similar size
- Better secured against spills, leaks and other accidents than most other packages
- Usually well marked

## Transporting Radioactive Materials

All shipments of radioactive materials, whether from industry or government, must be packaged and transported according to strict federal regulations. These regulations protect the public, transportation workers and the environment from potential exposure to radiation.





## Types of Radioactive Packaging

The most effective way to reduce the risks associated with transporting radioactive material is to follow the appropriate packaging standards specified by DOT and, when required, Nuclear Regulatory Commission (NRC) regulations. The type of packaging that should be used depends on the type and form of material to be shipped. Five basic types of packaging are used:

- Excepted packaging
- Industrial packaging
- Type A packaging
- Type B packaging
- Type C packaging



Excepted Packaging

Another option, strong-tight packaging, is still available for some domestic shipments of radioactive materials.

### Excepted Packaging

Materials with extremely low levels of radioactivity are shipped in excepted packages. Typical shipments include limited quantities of medical materials, medical diagnostic instruments, and articles such as smoke detectors.

### Industrial Packaging

Industrial packages are suitable for shipping materials with radioactivity levels that are lower than that which would pose an exposure threat. The container is designed to retain and protect the contents during normal transportation. Examples of items routinely shipped in industrial packages include contaminated equipment and radioactive waste that has been solidified in material such as concrete.



Industrial Packaging



When the level of a material's radioactivity exceeds that allowed for shipment in either excepted or industrial packaging, Types A and B packaging provide two higher levels of protection. These packages must demonstrate their ability to withstand a series of tests without releasing the contents. Regulations require that the package protect its contents and maintain sufficient shielding under conditions normally encountered during transportation.

## Type A Packaging

Typically, Type A packages are used to transport radiopharmaceuticals (radioactive materials used in medical diagnostics) and certain regulatory-qualified industrial products.

## Type B Packaging

Radioactive materials that exceed the limits of Type A package requirements must be shipped in Type B packages. Shippers use this type of package to transport materials capable of presenting a radiation hazard to the public or the environment in the case of a major release. For this reason, a Type B package must be fail-proof under simulated shipping conditions (capable of sustaining severe accidents).

## Type C Packaging

Type C packaging is designed to transport more highly radioactive (high-activity) material by air. These packages are submitted to a series of tests to prove their ability to withstand transport incidents and accidents—free drop, stacking or compression and penetration. Type C package requirements apply to all radionuclides.

Radionuclides are atoms with unstable nuclei, characterized by excess energy that is used in the radioactive decay process, resulting in the emission of gamma rays and/or subatomic particles such as alpha or beta particles. The resulting emissions are ionizing radiation which occurs naturally, or can be produced artificially.



Type A packages are made of fiberboard, wood or steel, and often have some shielding material for low specific activity (low specific activity) radioactive materials.



Radioactive materials that exceed the limits of type A package requirements must be shipped in type B packages.



Another example of type B packaging



Responders should never close block valves unless directed to do so by the pipeline company.

Pipeline markers may not always mark the exact location of a pipeline, and you should never assume the pipeline runs on a straight line between two markers.

## Pipelines as Containers

Pipelines are used primarily to carry liquid petroleum products, as well as natural and manufactured gas. Pipelines can be found in almost all areas of the country. Because they are buried underground, they go unnoticed for the most part. They generally provide safe transportation, but present significant hazards when they fail. The most common cause of pipeline failure is third party damage; someone other than the pipeline company digs into or otherwise damages the pipeline, allowing contents to escape.

Pipelines range in size from small lines (for residential service) to lines as large as 40 inches in diameter (for cross country transmission). Pipeline pressures can range from a few pounds in residential lines, to over 1,000 psig in transmission lines. Pipelines transport most of the country's finished petroleum products (gasoline and diesel fuel), as well as almost all of our natural gas. They serve as gathering lines for most of the nation's domestic crude oil supply. In industrial areas, responders can expect to find almost any chemical or gas in pipelines running between industrial facilities.

Pipeline right-of-ways are everywhere. In some areas, they run adjacent to railroads, risking damage from derailed railroad cars. Pipelines are buried at different depths and have block valves at different distances along the line. These block valves can be manually operated, but in most cases they are operated remotely from pipeline control offices in different parts of the country. Even if a pipeline is shut down immediately following a problem, it may take hours for the flow and pressure in the line to stop.

Many pipelines are dedicated to a single product; others transport multiple products (e.g., finished product petroleum lines). Markings for petroleum pipelines are usually placed on poles extending up from the ground. They usually display the word, WARNING, plus information on the type of product carried through the pipeline, along with the carrier's name and telephone number.

Markings for gas pipelines, on the other hand, are not standardized and may be located on poles or on the ground. The type of information provided on these markings varies greatly. The images on the next page are examples. The ERG provides additional information on pipelines on pages 14 - 19.

Familiarize yourself with pipeline locations and plan in advance for worst-case scenarios.





Right-of-Way Markings		
<p>DOT marker                  (on a post, at ground level or                  on a curb)</p>	<p>Flat fiberglass                  marker</p>	<p>Painted metal,                  concrete or plastic                  pipe</p>



Petroleum Pipeline Marker

Additional Pipeline Markings		
<p>Aerial Marker</p>	<p>Corrosion Test Station</p>	<p>Casing Vent Pipe</p>



Gas Pipeline Marker





## Predicting the Behavior of Hazardous Materials and Their Containers

STRESS	Thermal
	Chemical
	Mechanical
BREACH	Disintegration
	Runaway linear cracking
	Closures open up
	Punctures
	Splits or tears
RELEASE	Detonation
	Violent rupture
	Rapid relief
	Spill or leak
DISPERSE	Cloud
	Plume
	Cone
	Stream
	Pool
	Irregular deposits
	Hemisphere
IMPINGE	Short-term
	Medium-term
	Long-term
HARM	Thermal
	Radiation
	Asphyxiation
	Chemical
	Etiological (Biological)
	Mechanical

Before you can safely respond to emergencies involving hazardous materials, you have to understand how the hazardous materials and the containers that hold them, act and react. The goal is to predict behavior in order to determine if you can influence or stop the events.

The **General Hazardous Materials Behavior Model (GEBMO)** is an extremely reliable model that can be used to predict how hazardous materials incidents often unfold. The model was developed by Ludwig Benner, Jr. Benner noted that a hazardous materials incident is a sequence of events as identified in the model.

Benner's studies have shown that nearly all hazardous materials incidents follow six events or stages (see table on the left). These stages provide decision points or opportunities to intervene and change the outcome of the incident. For example, if your survey of the incident reveals a container has released its contents, you should consider action options which will decrease the amount of product being released, or stop the release and keep the product from engulfing surrounding exposures.

**The hazardous materials behavior model looks at several factors relating to the characteristics of the container and the product, and how failures of the container create hazards.** These factors include:

- Properties of the material: physical state (solid, liquid, gas) and chemical composition
- Characteristics of the container: rigidity, shape, pressure and construction features
- Natural laws of physics and chemistry: gravity, thermodynamics and chemical reactions

There is an interrelationship among these factors that will determine the behavior of the material, the container and the stored chemical energy of the system during an incident.



In his work, Benner notes that, if responders do not have the training, equipment or resources to change the outcome, there is no reason to intervene!



## Stress

Stress is a force or group of forces that act upon a container to strain, deform or otherwise affect the container's integrity. There are three types of stresses: thermal, mechanical and chemical.

### Thermal Stress

Thermal stress is the heating or cooling of the container and its contents. Examples of thermal stresses include fire, sparks, friction, electricity and changes in the ambient temperature. Clues that thermal stress is occurring include containers that are bulging or the operation of pressure relief devices. For example, heating can result in the material reaching its boiling point inside the container, enabling existing gases to further expand inside, subsequently causing a structural weakening of the container.

### Mechanical Stress

Mechanical stress is the transfer of energy from one object to another. The effects of this energy transfer can be a result of abrasion, which may decrease the shell thickness of the container, or be caused by a deformity of the container and/or its closures from dents, gouges, etc. Clues that mechanical stress has occurred, or is occurring, include punctures, tears, gouges or dents on the container.

### Chemical Stress

Chemical stress is the interaction between materials and/or their container. This stress can cause corrosion of the container, or generate internal temperature and pressure changes that may result in polymerization.

### Controlling Container Stress

Container stress can be controlled by redirecting the stressor, shielding the stressed system or moving the stressed container. The goal for responders is to influence the applied stress. For example, if the stress is due to fire, a thermal stressor, extinguishing the fire might be effective in keeping the container from breaching or releasing.



## Breach

A breach is the development of unwanted openings in a container when it is stressed beyond its recovery capacity. There are five types of breaches.

- **Disintegration:** the container suffers a cataclysmic failure (e.g., an explosion)
- **Runaway linear cracking:** a rapidly growing crack in a drum or pressure vessel that will encircle the container, violently break it into two or more pieces, and potentially cause a container failure—this is what happens during a BLEVE event
- **Closures opening up:** the attachments such as valves or pressure relief devices that open, or are sheared off, during the incident
- **Punctures:** an object pushes through the container wall
- **Splits or tears:** the container is ripped or abraded to the point of container failure

Each container breaches differently. The goal of the responder will be to influence the size of the breach. The type of breach will depend on the type (or construction) of the container and the type of stress to which it is exposed. Breaches may be controlled by chilling the contents (e.g., by adding water) to slow the release, limiting the stress levels or activating venting devices. Specialized training is required to perform some of these action options.

## Releases

A release is the escape of matter and energy from a breached container. The harm is related to the speed of the release. There are four types of releases:

- **Detonation:** a rapid, violent ignition of the product
- **Violent ruptures:** where the product is released under force in less than one second
- **Rapid relief:** a release from a pressurized container that may last from seconds to minutes
- **Spills or leaks:** a low or atmospheric pressure release that may last from minutes to days

When responding to incidents that involve gasoline, diesel, natural gas or propane, the goal for responders at this stage of an incident is to influence the quantity being released. Changing the rate of the release or stopping the release may be possible. For example, a 55-gallon drum that has fallen on its side and releasing its contents could be limited by changing the position of the drum. Responders with specialized training may be able to minimize the pressure differential by capping off the breach.



## Engulfment/Dispersion

Dispersion is the formation of predictable dispersion patterns leading away from the point of release. These patterns depend on the physical state of the material released. Engulfment occurs when the hazards, such as a vapor cloud, surround or completely cover an area.

- **Cloud:** formed by gas expanding in volume
- **Plume:** a cloud of product that has shape and buoyancy
- **Cone:** has a linear and radial dispersion that expands as it moves away from the point of release
- **Stream:** a liquid release that spreads around the ground and follows a downgrade slope
- **Pool:** collection of liquid in a low-lying area
- **Irregular deposits:** residue penetrating the ground, or materials entering open waterways
- **Hemisphere:** a dome shape, such as that formed by an explosion

The goal of the first responder, if an incident has reached the engulfment stage, is to influence the size of the danger zone. Engulfment can be controlled or limited by isolation, building dikes and dams, dilution with fog sprays and/or vapor dispersion. As a first responder at the operations level, you will use your knowledge of the chemical/physical properties of the hazardous materials involved, the container type and the use of the Emergency Response Guidebook to minimize the impact of the product that has been released.

## Impingement

Impingement refers to the duration of time that the material has contact with another object or exposure. Exposures include people (responders and civilians), property, the environment and critical systems (e.g., communication, transportation, water supply, electrical and gas). Three levels of impingement are included in the GEBMO model.

- **Short-term:** exposure or harm that results from minutes to hours
- **Medium-term:** exposure or harm that results from days to months
- **Long-term:** exposure or harm that results from months to years

The goal for responders at this stage is to minimize the number of exposures affected by shielding, sheltering-in-place and/or evacuation.



Three factors influence the level of harm:

1. **Duration** of exposure
2. **Intensity** of the impingement (i.e., how severe the exposure is)—which is dependent on concentration and toxicity
3. **Velocity** of the impingement—how quickly materials are moving

## Harm

Harm is defined as effects of exposure to hazardous materials and/or their container, and includes injury to people and damage to property and the environment.

## Possible Outcomes of Harm

Exposure to hazardous materials/WMDs, whether industrial or military, can severely harm first responders. While the signs and symptoms of hazardous materials exposure may differ depending on the type of agent and severity of the exposure, potential outcomes are the same:

- **Injury:** Injuries are not specific to incidents involving hazardous materials/WMDs. First responders should always take steps to prevent injuries on the fire/EMS/hazardous materials scene. Following established safe operating practices and maintaining awareness of the operating environment will help reduce harm from slips, trips, falls, lifting injuries and the like.
- **Illness:** Exposure to hazardous materials or WMDs can cause severe illness both immediately (acute) and for the rest of your life (chronic). The potential for harm can be substantially reduced by preventing exposure and by using PPE.
- **Death:** Depending on the route and severity of exposure, WMDs can cause death immediately or over time. Some WMDs can cause cancer, with repeated exposure, and all have potentially life-threatening acute and chronic effects. In addition, death can also come from physical trauma subsequent to a boiling liquid expanding vapor explosion (BLEVE), fire or explosion.
- **System Disruption:** Failure of critical segments of the infrastructure (e.g., gas, electricity, water, etc.) can be costly and paralyze the economy.



## TRACEM

TRACEM is a model, used by Ludwig Benner, that describes the types of harm people may incur from hazardous materials. The table below shows the types of harm, how the harm is caused, and the types of WMD attacks where each type of harm can occur.

Type of Harm	Results from exposure to...
Thermal	Extreme temperatures both hot and cold
Radiological	Energy in the form of waves or particles (alpha and beta) or gamma rays
Asphyxiation	Materials which affect the ability to take in or process oxygen
Chemical	Toxic or corrosive materials
Etiological	Biological agents such as bacteria, viruses and biological toxins
Mechanical	Contact with shrapnel or debris scattered as a result of a pressure release, explosion or BLEVE

By understanding the types of harm that hazardous materials and WMDs can cause, first responders determine the means to protect themselves from that harm.

### Estimating Outcomes

As part of **analyzing the problem**, first responders should be able to estimate the potential of harm to which people, property, the environment and the infrastructure may be exposed at a hazardous materials/WMD incident. During the initial size-up, they should consider the worst-case scenarios and then, as they collect and interpret information about the incident, they can modify their predictions accordingly. Knowing where in the sequence of events in the GEBMO will help responders estimate the outcomes. For example, if the container is breached, the next likely outcome would be that the product would be released.

To estimate the potential outcomes, responders should consider:

1. The size and the dimensions of the area affected
2. The number and type of exposures within and surrounding the area affected
3. The type, concentration and/or amount of the hazardous materials involved
4. The hazards present within the endangered area

Using the information gathered during the analysis stage of an incident, responders can develop an incident action plan (IAP).





## Summary Comparison of All Containers

Type of Container	Description
Non-pressure containers (bulk, non-bulk and fixed storage)	<ul style="list-style-type: none"><li>• Contain low vapor pressure liquids (flammable, poison, corrosive, etc.)</li><li>• Some contain solid materials or slurries</li><li>• Could contain any hazard class, except Class 2 (gases)</li><li>• Lightweight construction that is more susceptible to damage</li></ul>
Pressure containers (bulk, non-bulk and fixed storage)	<ul style="list-style-type: none"><li>• Contain high vapor pressure liquids, or compressed or liquefied gases</li><li>• Contain Class 2, 3, 4, 5, 6 and 8 materials</li><li>• Designed to contain pressure; those with welded seams are low pressure, and those designed for higher pressures are seamless</li></ul>
Cryogenic containers (bulk, non-bulk and fixed storage)	<ul style="list-style-type: none"><li>• Contain materials that are cooled to extremely low temperatures in order to liquefy them (by DOT definition, colder than -90°C (-130°F))</li><li>• Contain Class 2 (gases)</li><li>• These containers are designed like vacuum bottles</li><li>• Dewars have loose fitting caps to relieve pressure in the container, while larger non-bulk and bulk cryogenic containers have safety vents and pressure relief valves</li></ul>



## Lesson 2.9 - Pre-Incident Planning

### Lesson Objectives

After completing this lesson, you will be able to:

- Explain the importance of performing pre-incident planning.
- Identify the four components of a pre-incident plan, in accordance with the IAFF pre-incident planning procedures.
- Perform pre-incident planning for facilities within your jurisdiction using the IAFF's pre-incident planning template.



Access points to known high hazard areas should be identified early.



An important function of the safety officer is to assess hazards such as dangerous work surfaces and unstable loads.



## Pre-Incident Planning

### Component #1—Hazard Identification

Before visiting a facility, prepare for the on-site survey. Obtain information from public records such as E2 plans and risk management plans (RMPs) regarding:

- What the facility manufactures
- How supplies are stored
- What equipment is being used

In addition to fixed-site facilities, also develop pre-incident plans for:

- Transportation corridors: highways, waterways
- Landfills
- Construction sites
- Retail areas
- Underground storage tanks
- Utility right-of-ways
- Rail yards

### Component #2—Hazard Analysis

For work areas where hazardous materials exist, fire fighters focus on the complexities of dealing with individual product hazards. Other workplace hazards must also be recognized and managed to ensure the safest working environment possible and reduce associated risk. Common work area hazards include:

- Terrain and dangerous work surfaces
- Slip, trip and fall hazards
- Confined spaces
- Geographic separation
- Obscured visibility
- High noise environment
- Static electricity
- Operations requiring hoisting/lowering
- Unstable loads
- Lighting



It is vital to become familiar with specific facility markings and hazard locations.



### Component #3—Risk Assessment

To assess risks, obtain information regarding:

- Transportation frequency and routes
- Specific risks to people and property in vulnerable areas
- Past experiences with the material and the facility
- Existing control and safeguard mechanisms

A thorough hazard identification and risk assessment identifies fixed facilities posing the most concern to a community. Site-specific pre-incident plans should be developed for those facilities. Before conducting an actual inspection of a site, review all available information on the facility:

- Previous inspection reports
- Any prior pre-incident plans
- Drawings
- Permit applications
- History of fires or chemical incidents
- SDSs or lists of chemicals
- Exposures

### Component #4—Resource Analysis

Specify all resources that would be needed to control an incident such as:

- Personnel
- Supplies
- Equipment
- Funding
- Knowledge
- Expertise
- Access to other agencies
- Regulatory processes

After determining what resources will be needed to appropriately respond to an incident, inventory the actual resources and obtain necessary extras. Plan for ways to reduce risks, limit the consequences and improve response capabilities.



Frequent review of plans allows all responders to effectively perform their roles during an emergency.



## SECTION I - LOCATION INFORMATION

Location:		
Building/Site Name:		
Type of Business:		
Building Size—Frontage:	x Depth:	= Area:
Owner:		
Owner's Address:		
Owner's Telephone:		
Owner's Agent:		
Agent's Address:		
Agent's Telephone:		
Emergency Contact:		
Emergency Telephone:		
Cleanup Contractor:		
Prepared by:		
Remarks/Special Information (number of shifts, security on premises, special orders, other contacts not listed above, etc.):		



## SECTION II - BUILDING INFORMATION

Specific Property Use:	
Number of Stories:	Age of Building:
<b>Construction Type</b>	
1. Fire Resistive	5. Heavy Timber
2. Protective Non-Combustible	6. Unprotected
3. Protected Ordinary	7. Unprotected Ordinary
4. Protected Wood Frame	8. Unprotected Wood Frame
1st Type:                      %	2nd Type:                      %
Relevant Features:	
Type of Roof Construction:	
<b>Standpipes</b>	
Exterior Connections:	Locations:
Interior Connections—Wet:	Dry:
Location:	Type:
<b>Sprinkler Systems</b>	
Exterior Connection Location:	
% <b>Coverage</b> —Wet:	Dry:                      Both:
Shut-off Location:	
Valves—Open (Y/N):	Supervised (Y/N):                      Zoned Areas (Y/N):
<b>Other Extinguishing Systems (halon, CO<sub>2</sub>, dry powder, etc.)</b>	
Type:	Location:
<b>Warning System</b>	
Detection Type (heat, smoke, both):	
Alarm Company:	Telephone:
Access and Entrances:	





## SECTION II - BUILDING INFORMATION

### Facility Diagram

In the space below, diagram the facility layout and identify the locations of:

- ▶ Hazardous materials
- ▶ Emergency shut-off valves
- ▶ Built-in protection systems
- ▶ Water supply
- ▶ Building access and egress
- ▶ Vulnerable areas/Reactive materials



### SECTION III - HAZARDOUS MATERIALS INFORMATION

Note: If a Tier II Report is available then this section can remain blank and the Tier II Report can be used in its place.

Product Information			
Shipping Name:		UN #:	Class #:
Chemical Name:		CAS #:	
<input type="checkbox"/> Explosive	<input type="checkbox"/> Poison	<input type="checkbox"/> Gas	<input type="checkbox"/> Color:
<input type="checkbox"/> Flammable	<input type="checkbox"/> Radioactive	<input type="checkbox"/> Liquid	<input type="checkbox"/> Odor:
<input type="checkbox"/> Oxidizer	<input type="checkbox"/> Corrosive	<input type="checkbox"/> Solid	<input type="checkbox"/> Chemical Formula:
Average amount stored on site:			
Properties & Hazards			
Boiling Point:	Flash Point:	Specific Gravity:	Vapor Pressure:
Melting Point:	Ignition Temperature:	UEL:	LEL:
Vapor Density:		Soluble:	
Health Hazards			
Routes of Entry:		Target Organs:	
<input type="checkbox"/> Inhalation <input type="checkbox"/> Absorption: skin and eyes <input type="checkbox"/> Ingestion <input type="checkbox"/> Injection or puncture			
Container Information			
Container Type:		Capacity:	
Container Material:			
Container Used:		Features:	
<input type="checkbox"/> Fixed <input type="checkbox"/> Portable <input type="checkbox"/> Mobile		<input type="checkbox"/> Insulated <input type="checkbox"/> Pressurized <input type="checkbox"/> Armored Connection to Alarm (local, central, master, auxiliary):	



## Conducting an On-Site Pre-Incident Planning Survey

Before you conduct an inspection at the site, review all available information on the facility, including:

- Previous inspection reports
- Drawings
- Permit applications
- History of fires or chemical incidents
- SDSs or lists of chemicals
- Maps
- Adjacent vulnerable locations
- E2 reports
- Risk Management Plan (RMP)

To develop a comprehensive hazardous materials pre-incident plan for a facility, consider the following characteristics:

- Location/exposures
- Type of construction
- Type of business/process
- Water supply
- Building access
- Communications and security
- Electrical/gas shut-offs
- Water shut-offs and sprinklers
- Location/type/quantity of chemicals and their hazards
- Emergency medical support available
- Work schedules/number of employees
- Emergency resources on-site/contingency plans
- Protective clothing available on site
- Vulnerability of surrounding area/ability to evacuate
- Adjacent facilities and other exposures that cannot be evacuated or shut down
- Compatibility of resources
- Waterways and storm sewers, particularly those that empty into waterways

After locating the facilities and identifying the hazardous materials within each facility, you must identify the characteristics of the materials and the condition at the site to predict the consequences of a possible release and the appropriate actions. The range of a hazardous release depends not only on the amount of material released but also on the properties of the material. Technical experts, including toxicologists, may be needed to predict the areas of vulnerability in different situations. Computer-based management and chemical database programs, such as the Computer Aided Management of Emergency Operations (CAMEO) may also be used.



## Pre-Incident Planning Resource Identification Survey

A key task in pre-incident planning is the objective assessment of the capabilities and limitations of response personnel in dealing with potential emergencies at a fixed site or in a particular transportation corridor.

Personnel, apparatus, specialized equipment, mutual-aid and sustainability are among the issues that must be considered.

You will need to know:

- Who will be available for on-site technical assistance during normal hours and after-hours?
- Will there be an emergency telephone number posted for after-hours and weekend/holiday notifications?
- Will someone who is notified of an emergency be able to respond and represent the company in the decision-making process?
- Who is the liaison for the fire department?
- Does the facility have a response team? If so, how many trained personnel will be available during an emergency?
- To what level have site personnel been trained?
- Does the facility have special protective clothing for specific chemicals? If so, how many sets of clothing are available?
- Are facility personnel familiar with the fire department's incident management system?
- What type of communication system can be used for both facility personnel and fire fighters during an emergency?
- Are other information resources (such as technical specialists or chemists) available off-site?

The key to assessment is an educated judgment regarding emergencies that could occur and an honest appraisal of what response forces could reasonably be expected to accomplish in such situations.



Page left blank intentionally.



## Lesson 2.10 - Using the APIE Model

### Lesson Objectives<sup>1</sup>



#### NFPA® 472, 4.2.1

Given scenarios, identify those situations where hazmats/WMDs are present.

- (11) Identify examples of clues (other than occupancy/location, container shape, markings/color, placards/labels, SDS and shipping papers) to include sight, sound and odor which indicate hazmats/WMDs are present.
- (12) Describe the limitations of using the senses in determining the presence or absence of hazmats/WMDs.

#### NFPA® 472, 4.2.2 (1)

Identify the difficulties encountered in determining the specific names of hazmats/WMDs at facilities and in transportation.

#### NFPA® 472, 5.1.2.2, 5.2.1

- (1) Analyze a hazmat/WMD incident to determine the scope of the problem and potential outcomes.
  - (a) Survey a hazmat/WMD incident to identify the containers and materials involved, determine whether hazmats/WMDs have been released and evaluate the surrounding conditions.
  - (b) Collect hazard and response information from SDS; CHEMTREC; local, state, and federal authorities; and shipper/manufacturer contacts.
  - (c) Predict the likely behavior of hazmats/WMDs and their containers.
  - (d) Estimate the potential harm at a hazmat/WMD incident.

#### NFPA® 472, 5.2.1.4

Identify and list the surrounding conditions that should be noted when a hazmat/WMD incident is surveyed.

#### NFPA® 472, 5.2.1.5

Describe ways to verify information obtained from the survey of a hazmat/WMD incident.

### First Responder Acts as News Reporter

Like a news reporter, a first responder conducts a targeted search for a story's explanatory details.

#### Who:

- ▶ Who could help identify the hazardous product involved?
- ▶ Who is needed to safely respond?

#### What:

- ▶ What are the product's characteristics (form, behavior, quantity, etc.)?
- ▶ What is the worst-case scenario?

#### When:

- ▶ When is the incident occurring (time of day, weather conditions, etc.)
- ▶ When might the associated dangers increase?

#### Where:

- ▶ Where will the incident have the worst and longest effects?
- ▶ Where should victims be sheltered or evacuated?

<sup>1</sup> NFPA 472® Standard for Competence of Responders to Hazardous Materials/Weapons of Mass Destruction, 2013 Edition.





**NFPA® 472, 5.2.2**

- (4) Identify the following:
  - (a) Type of assistance provided by CHEMTREC and governmental authorities
  - (b) Procedure for contacting CHEMTREC and governmental authorities
  - (c) Information to be furnished to CHEMTREC and governmental authorities
- (5) Identify two methods of contacting the manufacturer or shipper to obtain hazard and response information.
- (7) Identify the procedure for contacting local, state, and federal authorities as specified in the emergency response plan and/or standard operating procedures.

**NFPA® 472, 5.2.3(1)**

Use the hazard and response information obtained from the current edition of the DOT Emergency Response Guidebook, SDS, CHEMTREC, governmental authorities, and shipper and manufacturer contacts.

**NFPA® 472, 5.2.4**

Given scenarios involving hazmat/WMD incidents, describe the potential harm within the endangered area.

- (2) Given the dimensions of the endangered area and the surrounding conditions at a hazmat/WMD incident, describe the number and type of exposures within that endangered area.
- (3) Identify resources available for determining the concentrations of a released hazmat/WMD within an endangered area.
- (4) Given the concentrations of the released material, describe the factors for determining the extent of physical, health, and safety hazards within the endangered area of a hazmat/WMD incident.



## APIE Process Applied

This four-stage process should be used to think through and carry out an emergency response.

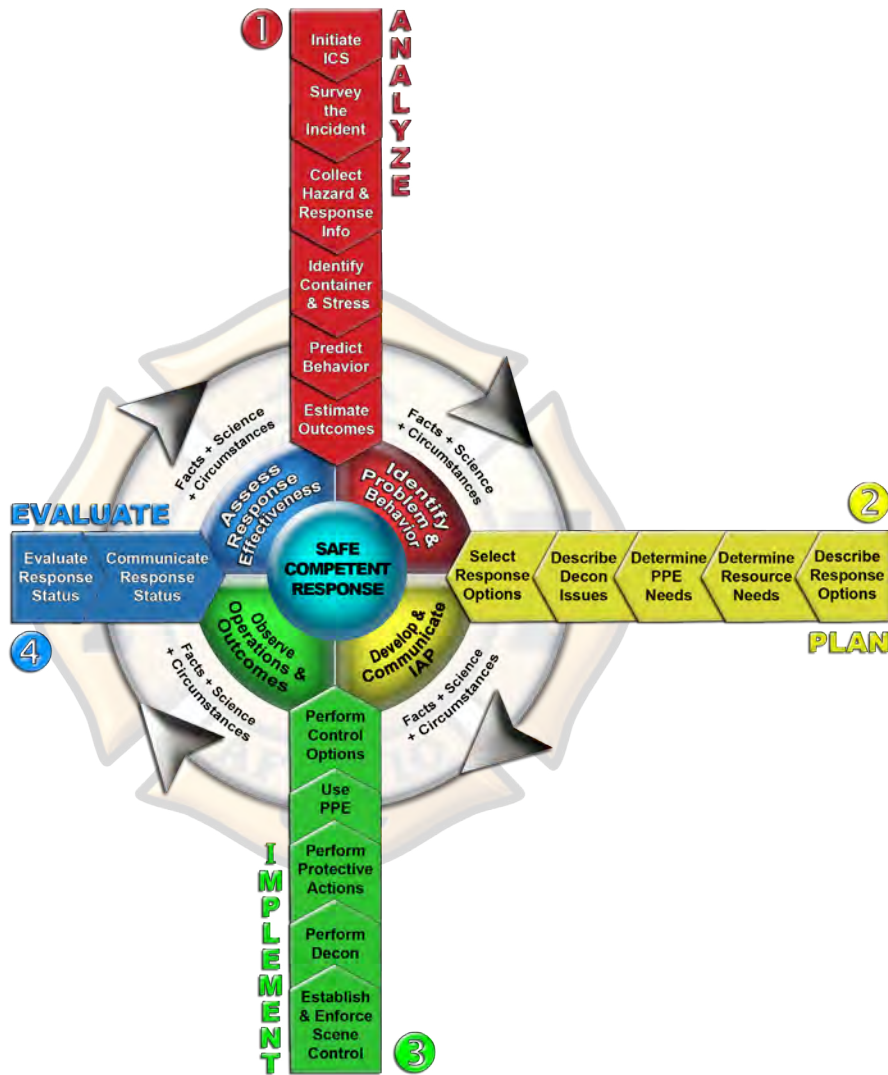

The APIE process can be applied to all types of emergencies, such as those at commercial fixed sites, along transportation corridors, at non-structural locations and at residences. Each stage of the process requires a set of standardized actions from first responders, as shown in the image above and the following page.



## APIE Checklist

The checklist below has been developed for working through hazmat/WMD incidents using the APIE process.

### Analyze the Problem

*GOAL = Identify the Problem and Likely Behavior*

- Initiate ICS
- Survey the incident
- Collect hazard and response information
- Identify container type and stress
- Predict behavior
- Estimate outcomes

### Plan the Response

*GOAL = Develop and Communicate the Incident Action Plan*

- Describe response objectives
- Determine personnel and/or equipment needs
- Determine PPE needs
- Describe decon issues
- Select response options

### Implement the Plan

*GOAL = Observe Operations and Outcomes*

- Establish and enforce scene control
- Secure area
- Crowd control
- Traffic control
- Zones determined
  - Hot
  - Warm
  - Cold
- Set up/perform decon
- Perform protective actions
  - Rescue/recovery
  - Evacuation
  - Shelter-in-place
  - Patient transport
- Use PPE
- Perform control options
- Preserve evidence

### Evaluate the Progress

*GOAL = Assess Response Effectiveness*

- Evaluate response status
- Communicate response status



## Analyze the Problem Using the APIE Model

The tasks described below should be followed when analyzing the problem at hazmat/WMD incidents in order to identify the problem and predict the likely behavior of the product(s) and container(s).

### Consider Dispatch Information

First responders are encouraged to ask for additional information to supplement the facts that were initially dispatched. If the involvement of a specific chemical can be ascertained, it can be researched while on the way to the scene to optimize response efficiency and effectiveness, and to take appropriate safety precautions.

### Initiate Incident Management System

Typically, command is assigned to the company officer of the first arriving unit. This **incident commander** must be identifiable and located at a command post as soon as practical, and will act as safety officer until a separate one is designated.

Though the incident commander has overall responsibility for the safety and health of fire department members at the scene, the **incident safety officer** is appointed to help manage this task. The safety officer assesses hazardous and unsafe situations at emergency incidents. In order to function effectively, this individual has the emergency authority to prevent or stop unsafe acts that present an immediate danger to life or health. The Safety Officer has an obligation to advise the incident commander of his actions.

First responders must secure the scene and control access to the area as early as possible during the incident. In most cases, the establishment of controlled access areas should start at an outside perimeter and work toward isolation of the contaminated area. The hot zone should be established after the outer perimeter is secured.

Numerous government agencies and private firms may become involved in hazmat incidents. Coordination of cooperating agencies may become too complex for the incident commander, so a **liaison officer** may need to be designated to assist in this function, thereby helping the incident commander maintain a manageable span of control.

The safety and security of response personnel and others in an area of an emergency response incident site is the incident commander's top priority. The use of a site safety plan helps assure the safety and health of responders on the site (OSHA 29 CFR 1910.120 HAZWOPER). Ideally, a site safety plan will be present at a location, in which case it can instrumentally inform, instruct and protect everyone involved.

### Key Point

Site-specific safety information, when present in pre-planning documents, aids efficient and effective resolution of emergency incidents.

### Topics for Safety Briefing (for all personnel operating at an incident)

- ▶ Chemical Hazards
- ▶ Use of the Buddy System
- ▶ Physical Hazards
- ▶ Decontamination
- ▶ Control Zones
- ▶ Site Map
- ▶ Communications
- ▶ Personal Protective Equipment



## Key Point

Operations level responders should be familiar with the standard operating procedures and/or guidelines (SOPs/SOGs) for contacting local, state and federal agencies during a hazardous materials/WMD incident.

## Survey the Scene

Surveying, or sizing-up, hazmat incidents is the same process used for other fire department responses. This process begins before the response, and continues beyond termination of the incident. Strategic priorities are the same: life safety (emergency responders and civilians), incident stabilization, environmental and property conservation. When conducting a size-up, position yourself uphill and upwind of any release, and consider terrain and weather conditions. Determine the identities, quantities, handling considerations and locations of the involved hazmats; by what means the material is spreading; and the hazards likely to result from the spill or release. Always verify UN identification numbers and the correct spelling of chemical names.

The appropriate evacuation distance for each incident must be based on release rates, hazards of the materials, environmental considerations (weather, topography) and time required for taking protective actions in specific areas. Detection devices can be used by trained personnel to assist in this decision-making process. It is also important to be alert for any signs and/or symptoms of exposure among personnel, civilians or animals including insects, birds and fish.

## Report Your Initial Findings

Once you have surveyed the scene, do the following:

1. Notify your agency of your findings including the surrounding conditions, exposures and vulnerable populations, weather conditions and topography.
2. If possible, contact the emergency phone number listed on the shipping papers.
3. If the emergency phone number is not listed on any available shipping papers, contact one of the emergency response agencies listed in the ERG.

The local, state and federal authorities that must be notified regarding a hazmat/WMD incident should be identified in your organization's SOPs/SOGs. Be prepared to provide as much of the following information as is possible:

- Your name, call back telephone number and fax number
- Location and nature of the problem (spill, leak, fire, etc.)
- Name and identification number of the material(s) involved
- Shipper/consignee/point of origin of the shipment
- Carrier name/rail car or truck number
- Container type and size
- Quantity of material being transported and released
- Local conditions (weather conditions, terrain, exposures, etc.)
- Injuries and number/type of exposures
- Emergency response agencies already notified



## Collect and Interpret Information

During a hazmat/WMD incident information can be obtained using emergency contact numbers on shipping papers or safety data sheets or by calling the transport providers. Determine what, if any, containers are in use, magnifying the image by using binoculars, if possible, so that you are able to maximize the distance between yourself and the hazard area. Examples of containers include:

- **Bulk Containers:** bulk bags, bulk bottles, cargo tanks, covered hopper cars, freight containers, gondolas, pneumatic hopper trailers, portable tanks and bins, protective overpacks for radioactive materials, tank cars, one-ton containers and van trailers
- **Non-Bulk Containers:** bags, bottles, boxes, carboys, cylinders, drums, multi-cell packages and wooden barrels
- **Facility Containers:** buildings, piping, reactors (chemical and nuclear), storage bins, tanks and storage vessels

Responders must evaluate container markings and estimate the amount of hazmats present, as well as the form of the material and the point of release. Reference materials must be consulted and a response action recommendation confirmed through more than one source.

Conditions surrounding the incident must be considered; responders should monitor the scene continuously for possible ignition sources. Accessibility must be evaluated and weather conditions, including general wind direction and forecasted conditions, should be noted.





### Emergency Numbers

CANUTEC: 1-613-996-6666 or  
\*666 on cellular

Environment Canada: See page 16

Canadian Center Occupational  
Health and Safety (CCOHS):  
1-800-668-4284  
905-570-8094

CHEMTREC: 1-800-424-9300

CHEM-TEL, INC: 1-800-255-3924

SETIQ: 91-800-00-214

CECOM: 91-800-00-413

ATSDR: 1-404-639-0615 or toll  
free at 1-888-422-8737

Poison Control: 1-800-POISON 1

### National Response Center (NRC)

The NRC maintains an emergency  
hotline for transportation incidents  
involving hazmats.

They also provide a routing service  
to alert federal authorities, if  
called regarding potential CBRNE  
incidents.

Their number is found in the  
Emergency Response Guidebook:  
1-800-424-8802, or in the  
Washington, D.C. area:  
1-202-267-2675

## Information Sources

Telephone hotlines can provide general information about hazards and possible responder actions. When calling a hotline in an emergency, be prepared to give all the information you can regarding the situation. Hotlines frequently used by emergency response personnel include the following.

### CHEMTREC

CHEMTREC provides 24-hour information for transportation incidents. This organization carries SDSs for most chemicals manufactured in the United States and is funded by the chemical industry.

CHEMTREC provides information on fixed site and transportation hazmat emergencies, and will give you immediate advice on the nature of the product and the steps you should take to handle the early stages of a problem. They will not, however, give you specific tactical advice. Tactical measures are specific to your department depending on personnel skills, knowledge and resources. After providing you with initial information, CHEMTREC will then contact the shipper of the hazmat for more detailed information and on-scene assistance if necessary.

CHEMTREC also maintains a current list of state and federal radiation authorities who provide information and technical assistance on handling incidents involving radioactive materials. Calls to CHEMTREC should be limited to emergencies only.

### CANUTEC (Canadian Transport Emergency Centre)

CANUTEC provides a similar service in Canada. It is located in Ottawa and is operated by the Transport Dangerous Goods Directorate of Transport Canada. CANUTEC provides a national bilingual advisory service and is staffed by professional chemists experienced and trained in interpreting technical information and providing emergency response advice.

CANUTEC has set up a scientific data bank on chemicals manufactured, stored and transported in Canada. It is staffed by professional scientists specialized in emergency response and experienced in interpreting technical information and providing advice.



## CHEM-TEL, INC.

CHEM-TEL, INC. is another emergency response communication service that works collaboratively with other organizations to inform emergency responders.

CHEMTREC, CHEM-TEL, INC. and CANUTEC all assist one another in providing information to emergency responders. Their telephone numbers are cited near the front of the Emergency Response Guidebook.

## Agency for Toxic Substances and Diseases Registry (ATSDR)

The ATSDR provides technical assistance on the health effects of poison and toxic substances. They can be reached via telephone at 1-404-639-0615 or toll free at 1-888-422-8737.

## Poison Control

Poison Control can provide information to assist in the treatment of exposed individuals.

## Other Hotlines and Help Lines

Many manufacturers and shippers maintain telephone help lines. During the pre-planning process, contact area chemical manufacturers about hotlines or resources they recommend for you to use in the case of an emergency.

In addition, you can maintain a list of regional, state and local emergency resource numbers. These may include regional response teams from the Environmental Protection Agency, response teams from the Department of Energy, or regional/local resources in your area.

## National Response Center (NRC)

The NRC, which is operated by the U.S. Coast Guard, receives reports required when dangerous goods are spilled. After receiving notification of an incident, the NRC will immediately notify the appropriate federal on-scene coordinator and concerned federal agencies.

**Federal law requires that anyone who releases into the environment a reportable quantity of a hazardous substance (including oil when water is, or may be affected) or a material identified as a marine pollutant, must immediately notify the NRC.** When in doubt as to whether the amount released equals the required reporting levels for these materials, the NRC should be notified.

CALL NRC (24 hours)  
1-800-424-8802

(Toll-free in the U.S., Canada and  
the U.S. Virgin Islands)  
202-267-2675  
in the District of Columbia

Calling the emergency response telephone number, CHEMTREC®, CHEMTEL, INC., INFOTRAC or 3E COMPANY, does not constitute compliance with regulatory requirements to call the NRC.



## EPA Offices

### Region 1 – Boston

CT, ME, MA, NH, RI and VT  
Plus 10 Tribal Nations

*5 Post Office Square - Suite 100  
Boston, MA 02109-3912  
1-888-372-7341*

### Region 2 – New York City

NJ, NY, Puerto Rico and the U.S.  
Virgin Islands  
Plus 8 Tribal Nations

*290 Broadway  
New York, New York 10007-1866  
877-251-4575*

### Region 3 – Philadelphia

DE, DC, MD, PA, VA and WV

*1650 Arch Street  
Philadelphia, PA 19103-2029  
800-438-2474*

### Region 4 – Atlanta

AL, FL, GA, KY, MS, NC, SC and  
TN  
Plus 6 Tribes

*61 Forsyth Street SW  
Atlanta, GA 30303-8960  
800-241-1754*

### Region 5 – Chicago

IL, IN, MI, MN, OH and WI  
Plus 35 Tribes

*77 West Jackson Blvd.  
Chicago, IL 60604  
312-353-2000*

### Region 6 – Dallas

AR, LA, NM, OK and TX  
Plus 66 Tribes

*1445 Ross Ave.  
Dallas, TX 75202-2750  
(800) 887-6063*

### Region 7 - Kansas City

IA, KS, MO and NE  
Plus 9 Tribal Nations

*11201 Renner Blvd.  
Lenexa, KS 66219  
800-223-0425*

### Region 8 – Denver

CO, MT, ND, SD, UT and WY  
Plus 27 Tribal Nations

*80C-EISC  
1595 Wynkoop St  
Denver, CO 80202-1129  
303-312-6312*

### Region 9 - San Francisco

AZ, CA, HI, NV, American Samoa,  
Mariana Islands, Micronesia,  
Guam, Marshall Islands and Palau  
Plus 148 Tribal Nations

*75 Hawthorne Street  
San Francisco, CA, 94105  
415 947-8000*

### Region 10 – Seattle

AK, ID, OR and WA  
Plus 271 Native Tribes

*1200 Sixth Avenue, Suite 900  
Seattle, WA 98101  
206-553-1200*



## Assess Vulnerable Populations

The incident commander evaluates the need for rescue and determines appropriate protective actions when groups of people are involved. **Rescue of endangered individuals at hazmat/WMD incidents should not be performed unless the rescuers can do so safely.** Initial rescue actions should be devoted to removing able-bodied persons from immediate danger. Complicated rescues or difficult extrications should be evaluated thoroughly before attempted. The dangers of exposure to an unknown chemical or a potential explosion may make the risks outweigh the benefits. In making this decision, the incident commander must consider risk potential, as well as outcome likelihood.

When contaminated individuals are rescued, the incident commander must arrange for the isolation, decontamination, triage and treatment of these patients and the rescuers. Contaminated patients may have to be held in an isolated area until they can be decontaminated.

It may become necessary to initiate protective actions for large groups of people in areas surrounding a hazardous release to prevent exposure, injury or death. The two protective actions for vulnerable populations are evacuation and sheltering-in-place. **The decision to evacuate or shelter-in-place must be based on the released material's physical and chemical properties, atmospheric and ground conditions, rate of release and the likely duration.** The information gathered from direct observation, input from other unit members, and consultation with references and other resources should guide the incident commander in making this decision.

For example, areas surrounding the site of a possible explosion are likely to require evacuation. A toxic plume may threaten the health of residents downwind, so anyone who will remain sheltered in their homes should be given instructions.

Your department should have specific procedures for both in-place protection and evacuation of vulnerable populations. Keep in mind that the **Emergency Response Guidebook** deals only with the initial phase of response following the release. Additional protective actions may have to be taken after that initial phase.

### In-Place Protection

In-place protection may be a viable alternative to evacuation, and should be considered if:

- ▶ Fire spread potential is minimal.
- ▶ The release is expected to be short-term and low-level.
- ▶ Vulnerable populations, such as the elderly and the sick, could sustain greater injury during evacuation than by staying in place and taking appropriate protective actions.
- ▶ Vulnerable populations can be safely sheltered in place. (If possible, consider monitoring.)



Page left blank intentionally.



## Estimating Potential Harm at a HazMat/WMD Incident

Knowing the potential harm—thermal, radiological, asphyxiating, chemical, etiological and/or mechanical—will help first responders conduct a risk-benefit analysis. The process for estimating the potential harm (outcomes) within an endangered area at a hazmat/WMD incident includes:

1. Determining the dimensions of the endangered area
2. Estimating the number of exposures within the endangered area
3. Measuring or predicting concentrations of materials within the endangered area
4. Estimating the physical, health and safety hazards within the endangered area
5. Identifying the areas of potential harm within the endangered area
  - **Where are people in relation to the hazmats/WMDs?**
  - **Are there additional hazmats/WMDs present?**
6. Estimating the potential outcomes within the endangered area

Resources for determining the size of an endangered area of a hazardous materials/WMD incident are the current edition of the DOT Emergency Response Guidebook and plume dispersion modeling results from facility pre-incident plans.





Risk-benefit analysis: substantial risk requires prospect of substantial benefit.

### Key Points

When actions are directed toward property conservation only, fire fighters should only be subjected to low risk environments. Risk nothing for people and property already lost.

When actions are directed toward the rescue of trapped victims who have a low probability of survival, fire fighters may be subjected to moderate risk environments.

When actions are directed toward the rescue of trapped victims who have a high probability of survival, fire fighters must weigh high risk environments against the odds of saving a viable life.

## Conduct a Risk-Benefit Analysis

Many fire fighters learn from early training that aggressive tactics are necessary for success. They are taught to visually assess a building for entry potential in a fire situation. The usual response is to enter the structure, search for trapped occupants and conduct fire department operations that lead to extinguishment. This strategy exposes response personnel to the hazards of fire fighting, including (1) hazmats that are generated by the fire, and (2) materials that may be stored in the structure and released in the course of the incident. In suspected hazmat incidents, such aggressive tactics are not wise without clear information about the hazards.

The risks taken by response personnel must be justified—and outweighed—by the likely benefits of their actions.

The appropriate choice between offensive and defensive operations at a hazmat incident may not always be evident, especially if victims are involved. You must carefully consider the points listed on the next page.

	Low Risk	High Risk
Low Benefit	<p>Perform Offensive or Defensive Operations</p> <p><i>Example: Abandoned office building at night with a fire alarm sounding; no visible smoke or fire and no sprinkler activation</i></p>	<p>Perform Defensive Operations</p> <p><i>Example: Fiery motor vehicle crash with an obvious fatality and hazmat involvement</i></p>
High Benefit	<p>Perform Offensive Operations</p> <p><i>Example: Conscious and alert victim of vehicle crash involving a hazmat carrier with no spill, leak or fire</i></p>	<p>Perform Offensive or Defensive Operations</p> <p><i>Example: A fiery motor vehicle crash involving a lightly entangled, conscious and alert driver screaming to be rescued</i></p>

The determination to rescue, and how to prioritize the medical care of the victims of a hazmat/WMD incident, must be based on sound information, adequate PPE and appropriate numbers of trained personnel. Considerations for prioritizing the decontamination order can be broken into ambulatory/non-ambulatory and life threatening and non-life threatening injuries.



## Rescue Checklist

It is important to consider all of these factors when developing a strategy. No rescue should be attempted when the level of risk to the rescuer(s) is unacceptably high.

### The Rescuers

- Are rescuers adequately skilled and experienced? What is their level of training?
- Are necessary environmental monitoring devices available to rescuers?
- Is available personal protective equipment (PPE) appropriate for the hazmat(s) involved?
- Is adequate staffing available for support positions such as fire suppression, safety and backup crews?
- How much time will the extrication and rescue require?
- Could conditions change/worsen over time?
- Are proper tools available to initiate extrication and treatment?
- If necessary, has a decon area been established?

### The HazMats/WMDs

- What is the identity of the material(s)?
- If the released material is visible, is it pooling or vaporizing in the area around the victim?
- What are the properties of the involved material?
- Are ignition sources present? Is a large fire or explosion likely?
- How much material is involved? What is the release rate of the hazmat(s)?
- Is there any information regarding the concentration of material in the area surrounding the victim?
- If a container or vehicle is involved, what is its condition? Is it stable?

### The Victim(s)

- Has the person(s) requiring rescue been seen or are they otherwise known to exist?
- How long has the victim been trapped or exposed to the hazmat? Is he or she viable?
- Is the victim trapped by a vehicle or other debris?

Local SOPs/SOGs of the authority having jurisdiction will drive the rescue and decontamination process. In most cases, medical care is performed in a safe area away from the hazard and after decontamination. Medical care providers should understand the nature of the incident, and be provided with available information regarding the nature and characteristics of the hazmats involved.



## Key Points

- ▶ For property conservation only: First responders should not take risks
- ▶ Victims with low probability of survival: Moderate risk may be assumed for potentially moderate gain
- ▶ Victims with a high probability of survival: High risk for prospect of high gain

Review the following scenarios and then make a decision about whether first responders should attempt a rescue of victims at the scene. Be sure to defend your answer.



You arrive at the scene of an incident where a van has overturned on a major highway. You notice that there is a Radioactive Placard, Class 7 on the side of the van. The driver of the van is obviously injured, but able to move. **Would you attempt to rescue the driver? Why?**

At 3 a.m. on a Tuesday morning, you arrive at a mobile home parking lot where there is a propane leak from a 200-gallon tank. There is a visible vapor cloud three feet high surrounding several mobile homes. **Is it a gas or liquid leak? What are your first actions?**

You respond to a call at a small chemical plant. Upon your arrival at the scene you are told by the plant manager that there is a fire in a processing unit. Plant workers report that two coworkers are in the area of the fire and the explosion. The fire is impinging on several closed containers in the processing unit. **What should you do in this situation? If you need more information before making a decision, what do you need to know?**

At 10 a.m. on a Monday morning, you respond to an incident at a construction site. Upon arrival, you discover an unconscious worker slumped over the controls of a piece of heavy machinery that has apparently ruptured a natural gas pipeline. **What are your actions if there is no fire yet?**



## Module 3 - Plan the Initial Response

### Lesson 3.1 - Response Objectives and Action Options

#### Lesson Objectives<sup>1</sup>

##### **NFPA® 472, 5.3.1**

Given scenarios involving hazmats/WMDs, describe the response objectives.



- (1) Given an analysis of a hazmat/WMD incident and the exposures, describe the number of exposures that could be saved with the resources available.
- (2) Given an analysis of a hazmat/WMD incident, describe the steps for determining response objectives.
- (3) Describe how to assess the risk to a responder for each hazard class in rescuing injured persons at a hazmat/WMD incident.
- (4) Describe the potential for secondary attacks and devices at criminal or terrorist events.

##### **NFPA® 472, 5.3.2**

Given examples of hazmat/WMD incidents (facility and transportation), identify the options for each response objective.

- (1) Identify the options to accomplish a given response objective.
- (2) Describe the prioritization of emergency medical care and removal of victims from the hazard area relative to exposure and contamination concerns.

##### **NFPA® 472, 6.6.3.1**

Given examples of hazmat/WMD incidents, identify the options for each response objective.

- (1) Identify the options to accomplish a given response objective.
- (2) Identify the purpose for and the procedures, equipment, and safety precautions associated with each of the following control techniques:
  - (a) Absorption
  - (b) Adsorption
  - (c) Damming
  - (d) Diking
  - (e) Dilution

<sup>1</sup> NFPA 472® Standard for Competence of Responders to Hazardous Materials/Weapons of Mass Destruction, 2013 Edition.



- (f) Diversion
- (g) Remote valve shutoff
- (h) Retention
- (i) Vapor dispersion
- (j) Vapor suppression

**NFPA® 472, 6.6.4.1**

Given an incident action plan for a hazmat/WMD incident, within the capabilities and equipment provided, demonstrate control functions set out in the plan.

- (1) Using the foam equipment furnished, demonstrate the application of the foam(s) or agent(s) on a spill or fire involving hazardous materials/WMD.
- (2) Identify the characteristics and applicability of the following Class B foams:
  - (a) Aqueous film-forming foam (AFFF)
  - (b) Alcohol-resistant concentrates
  - (c) Fluoroprotein
  - (d) High-expansion foam
- (3) Given the required tools and equipment, demonstrate how to perform the following control activities:
  - (a) Absorption
  - (b) Adsorption
  - (c) Damming
  - (d) Diking
  - (e) Dilution
  - (f) Diversion
  - (g) Retention
  - (h) Remote valve shutoff
  - (i) Vapor dispersion
  - (j) Vapor suppression
- (4) Identify the location and describe the use of emergency remote shutoff devices on MC/DOT-306/406, MC/DOT-307/407 and MC-331 cargo tanks containing flammable liquids or gases.
- (5) Describe the use of emergency remote shutoff devices at fixed facilities.

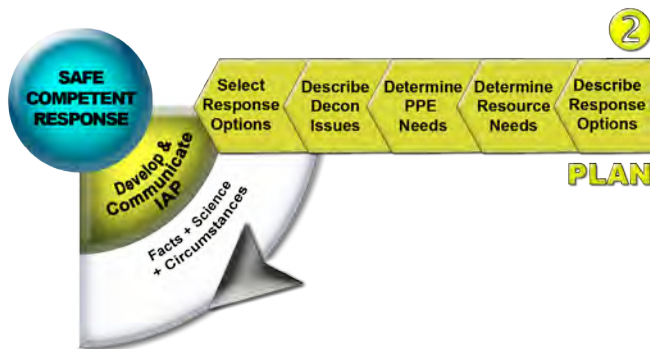



## Plan the Response Using the APIE Model

The tasks described below should be followed when planning the response at hazmat/WMD incidents in order to develop and communicate an incident action plan.

- Describe response objectives.
- Determine personnel and/or equipment needs.
- Determine personal protective equipment needs.
- Describe decontamination issues.
- Select response objectives.

## Describe Response Objectives

Planning a response entails understanding the nature of an incident and determining a course of action that will favorably change the outcome. On the surface, this seems like a straightforward, uncomplicated task. In truth, the decision to act can be one of the most difficult acts at the emergency scene due to the unforeseen dangers that may present at the incident.

When planning an initial response to a hazmat/WMD incident **one critical mental priority** must be kept in mind at all times: **the safety and survivability of all responding personnel**.

Remember, as a first responder, you are there to select the appropriate response options, including isolating, containing and/or remedying the problem—not to become a casualty of the incident. The APIE decision making model's core value exemplifies the use of a safe and competent response by all emergency personnel. Proper incident planning will keep responders safe and provide a means to control the incident effectively, preventing further harm to persons or property.

Fire fighters have an array of offensive and defensive measures at their disposal to respond to routine fires. However, when hazardous materials/WMDs are involved, first responders at the operations level of training need to limit their actions to isolating the dangerous material with **defensive tactics**. More than one of these strategies may be used in the course of mitigating any one hazmat incident.

Three initial response objectives responders, at the operations level, should address at hazmat/WMD incidents are:

1. Restrict public access by establishing an isolation perimeter (boundary).
2. Determine the hazmat/WMDs involved (e.g., by using the clues and the ERG).
3. Review the potential hazards.





## Extinguishment

Extinguishment can be accomplished using a variety of materials, such as water, foam or dry sand. The most common fire fighting technique is water application.

Applying water to some hazmats would be inappropriate, especially if the material is water-reactive, or the application of water could result in toxic run-off that cannot be contained.

Most fire fighting foams are designed to extinguish Class B fires (flammable liquids), though some foams are used exclusively on Class A fires (ordinary combustibles). In general, foams extinguish fire by blanketing the burning material. The foam blanket provides a physical barrier between the burning materials (the vapors) and the flames; it also provides a barrier between the fuel and oxygen in the air, suppressing vapors that would ordinarily rise.





## Foam Application (Performance Checklist A-35)

Foam effectiveness is directly related to its blanketing and sealing capability. A variety of different foams have been formulated because the same one does not work on all burning liquids. All fire fighting foams are relatively expensive, requiring specialized equipment and knowledge for application. The most widely used foams are protein foam, fluoroprotein foam, polar solvent alcohol-resistant foam, aqueous film-forming foam (AFFF), hazmat foam and high expansion foam. Consult the ERG for the type of foam to use on a specific product.

### Protein Foams

Protein foams are designed for use on hydrocarbon fuels. Careful application is critical because this type of foam loses effectiveness if it becomes coated with the hydrocarbon liquid. In addition, protein foams do not flow or seal as well as the newer fluoroprotein foams, and they are not effective on polar solvents. Protein foams will break down with application, and breakdown is faster when the foam is heated.

### Fluoroprotein Foams

Fluoroprotein foams are protein foams fortified with fluorinated solvents that enable them to shed hydrocarbon liquids, so they remain effective even when submerged. They can be used in subsurface foam injection systems in fuel storage tanks.

### Aqueous Film-Forming Foam (AFFF)

Aqueous film-forming foam (AFFF) was designed to fight aircraft fuel fires; it shares characteristics of fluoroprotein foams. AFFF forms a film on the fuel's surface, which allows it to spread quicker than other fluoroprotein foams, and reseal if the seal is broken. AFFF can rapidly extinguish fires, but does not tolerate heat and direct flame impingement as well as some of the other foams. Even a small fire can destroy the blanket.

### Polar Solvent Alcohol-Resistant Type Concentrate Foams

Polar solvent alcohol-resistant type concentrate foams are not destroyed by alcohols, polar solvents and other water soluble liquids as are most other fire fighting foams. While polar solvent foams do not break down when used on polar solvents, they are expensive to use because they must be applied in higher concentrations. It is an alcohol-type concentrate, referred to as AFFF-ATC.



### Hazmat Foams

Hazmat foams are used primarily to suppress vapors from released corrosive materials. They also reduce the chance of ignition or re-ignition.

### High Expansion Foams

High expansion foams can expand up to 1,000 times their volume while most other foams do not expand beyond 100 times their volume. These foams were designed to extinguish Class A fires in confined spaces by completely flooding the area. They displace vapor, heat and smoke. As they break down, they convert to steam, absorb heat and reduce oxygen in the confined atmosphere.



## Vapor Suppression (Performance Checklist A-34)

Vapor suppression uses water fog or foam, depending on the hazmats involved, to reduce the emission of vapors at a spill. As with any tactical operation, full personal protective equipment must be worn. In cases where turnouts and SCBA cannot provide adequate protection, you must not subject yourself to any potential exposures or contamination.



## Vapor Dispersion (Performance Checklist A-43)

Vapor dispersion involves moving gas/vapor to another area, or diluting its concentration in air to reduce its hazardous effects. A large caliber fog stream or fan can move great amounts of air via hydraulic ventilation, which explains its effectiveness on gas/vapor releases. This method only moves the hazard to another area or reduces its concentration—which may be all that is necessary to protect the endangered area. When fog streams are used on water soluble gases or vapors, the product itself may be absorbed by the water. This may cause a residual hazardous, evaporating solution—not ideal, but perhaps necessary for the protection of an area.

## Absorption (Performance Checklist A-35)

Absorbents soak up released material like a sponge. Typical absorbent materials include clay, sawdust, charcoal (not activated charcoal), and commercially available absorbent: particulates, socks, pans and pillows. Some absorbents may be designed for specific chemicals.

One disadvantage of using absorbents is that you must work in very close proximity to the spilled material. Therefore, absorption should only be attempted if turnout gear and SCBA can provide adequate protection against the material.

## Adsorption (Performance Checklist A-36)

Adsorbents, such as activated charcoal (sometimes referred to as activated carbon), interact by adhering to, or attaching themselves to, liquid hazmats. Other examples of adsorbent materials include aluminum oxide and silica gel, which is an amorphous form of silicon dioxide. Unlike absorbents, adsorbents generally do not swell.

Two factors should be considered when selecting this action option: (1) chemical compatibility between the product and the adsorbent to avoid dangerous reactions and, (2) ignition sources, as the interaction of the product and the adsorbent produces heat.



Underflow Dam

### Performance Checklists:

- ▶ Damming, page A-37
- ▶ Diking, page A-38
- ▶ Diversion, page A-40
- ▶ Retention, page A-41



## Dikes, Dams, Diversion and Retention Areas

Dikes, dams, diversion and retention areas prevent the spread of spilled material. Dikes are used to control releases on land, especially around a leaking container. Diking involves building a raised partition of soil, clay or a combination of materials around the spill.

Diking around a manhole cover

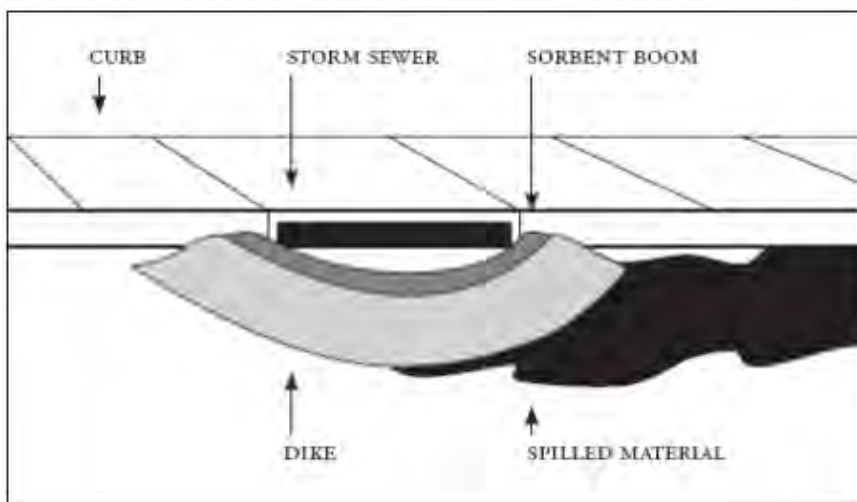
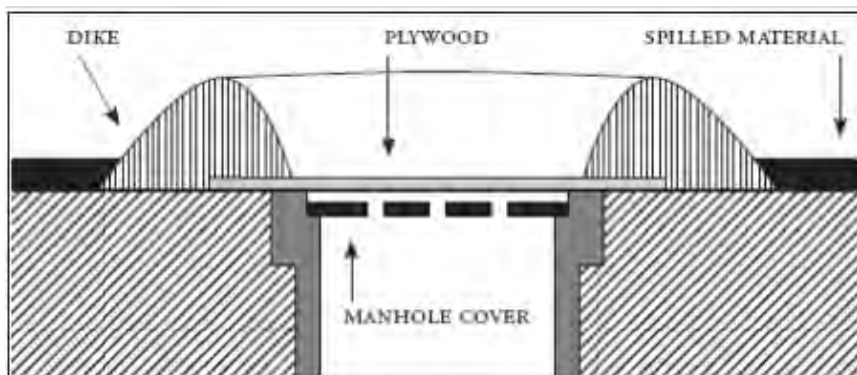

Diking around a sewer

Dams are barriers, usually built in ditches, streams or creeks, that stop the downstream movement of released material. Diversion barriers channel spilled material into a containment area and require the same type of equipment and materials as diking.

Retention areas include holding pits and ponds used to catch and hold released material until it can be disposed of. Digging retention areas can require use of heavy equipment, which can introduce its own health/safety risks over and above those posed by the incident.

Using dikes, dams, retention areas and various diversion methods requires the ability to estimate the amount of material that may be released and create a barrier before the dangerous good enters the area. Turnouts and SCBA must be adequate to protect you from any harmful effects. If available gear cannot provide adequate protection, control plans need to be revised.





## Booms: Absorbent and Retaining

Booms are composed of materials that float on top of the water, providing a barrier against the movement of floating insoluble materials. Booms are used to contain the released hazmats. There are two types of booms:

- **Absorbent Booms:** These booms collect the hazmats release as they come in contact with the boom.
- **Retaining Booms:** This type of boom contains a curtain or skirt that hangs under the water to collect hazmats.

Boom System, Overhead View

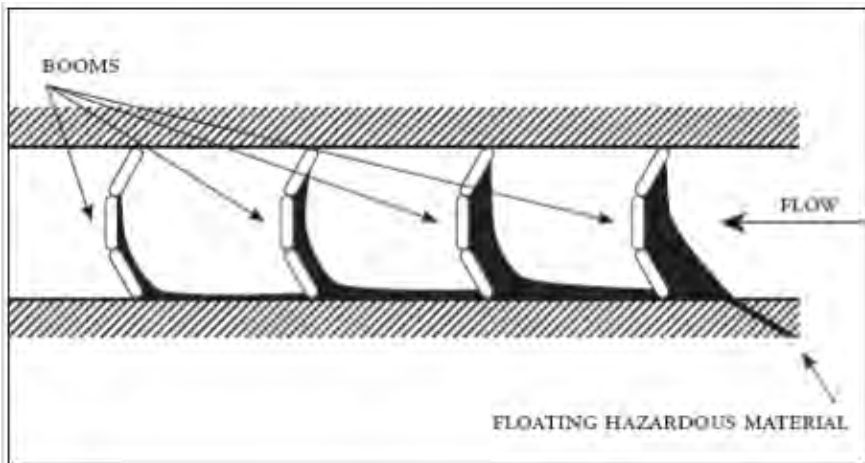

The **filter fence** is staked in flowing water within streams and rivers, and uses available sorbent (such as hay or wheat straw) to catch contaminated materials (given they are lighter than water).

Filter Fence

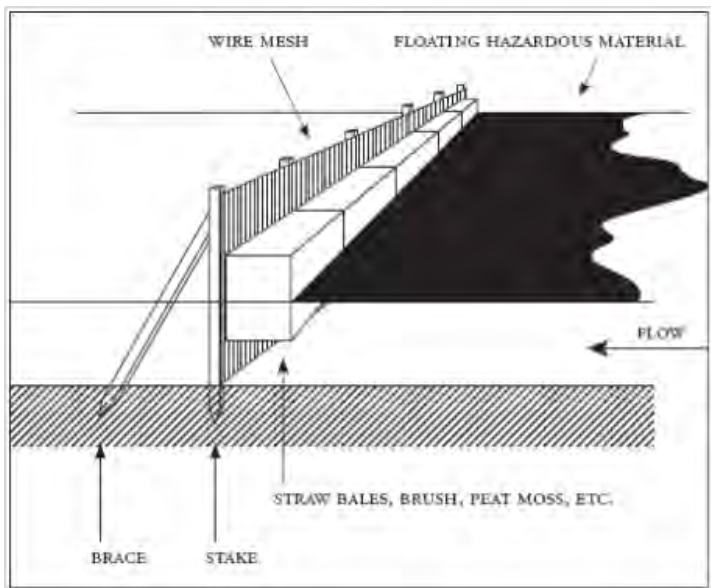

Examples of Filter Fences





### **Dilution (Performance Checklist A-39)**



The hazards associated with water-soluble materials can be reduced by applying water to the material. Although dilution is often used during decontamination, it is rarely used for spill control—the application of water increases the volume of the hazmats and creates a runoff problem which may be difficult to contain. The dilution process should only be performed under the direction of a hazmat technician, an allied professional and/or an SOP/SOG.

### **Remote Valve Shut-Off (Performance Checklist A-42)**

There are limited situations where an operations level responder may perform remote valve shut-off, which is considered an offensive tactic. Responders at the operations level may be tasked with closing remote valves in situations involving gasoline, diesel, liquefied petroleum gas and natural gas fuels. In these cases, operations level responders may perform this offensive task provided they have the appropriate training, procedures, equipment and PPE.



## Lesson 3.2 - Personal Protective Equipment

### Lesson Objectives<sup>1</sup>

#### NFPA® 472, 5.3.3



- (1) Identify the respiratory protection required for a given response option and the following:
  - (a) Describe the advantages, limitations, uses, and operational components of the following types of respiratory protection.
    - i. Positive pressure self-contained breathing apparatus (SCBA)
    - ii. Positive pressure air-line respirator with required escape unit
    - iii. Closed-circuit SCBA
    - iv. Powered air-purifying respirator (PAPR)
    - v. Air-purifying respirator (APR)
    - vi. Particulate respirator
  - (b) Identify the required physical capabilities and limitations of personnel working in respiratory protection
- (2) Identify the personal protective clothing required for a given option and the following:
  - (a) Identify skin contact hazards encountered at hazmat/WMD incidents.
  - (b) Identify the purpose, advantages and limitations of the following types of protective clothing at hazmat/WMD incidents:
    - i. Chemical-protective clothing such as liquid splash-protective clothing and vapor-protective clothing
    - ii. High temperature-protective clothing such as proximity suits and entry suits
    - iii. Structural fire-fighting protective clothing

<sup>1</sup> NFPA 472® Standard for Competence of Responders to Hazardous Materials/Weapons of Mass Destruction, 2013 Edition.



**NFPA® 472, 5.4.4**

Given the PPE, describe considerations for the use of PPE.

- (1) Identify the importance of the buddy system.
- (2) Identify the importance of the backup personnel.
- (3) Identify the safety precautions to be observed when approaching and working at hazmat/WMD incidents.
- (4) Identify the signs and symptoms of heat and cold stress and procedures for their control.
- (5) Identify the capabilities and limitations of personnel working in the PPE.
- (6) Identify the procedures for cleaning, disinfecting and inspecting PPE.
- (7) Describe the maintenance, testing, inspection and storage procedures for PPE.

**NFPA® 472, 6.2.3.1**

Given scenarios involving hazmat/WMD incidents with known and unknown hazmats/WMDs and PPE, select the PPE required to support mission-specific tasks.

- (1) Describe the types of PPE that are available for response based on NFPA standards and how these items relate to EPA levels of protection.
- (2) Describe PPE options for the following hazards:
  - (a) Thermal
  - (b) Radiological
  - (c) Asphyxiating
  - (d) Chemical
  - (e) Etiological/biological
  - (f) Mechanical
- (3) Select PPE for mission-specific tasks at hazmat/WMD incidents based on local procedures.
  - (a) Describe the following terms and explain their impact and significance on the selection of chemical protective clothing:
    - i. Degradation
    - ii. Penetration
    - iii. Permeation
  - (b) Identify at least three indications of material degradation of chemical-protective clothing.



- (c) Identify the different designs of vapor-protective and splash-protective clothing and describe the advantages and disadvantages of each type.
- (d) Identify the relative advantages and disadvantages of the following heat exchange units used for the cooling of personnel operating in PPE:
  - i. Air cooled
  - ii. Ice cooled
  - iii. Water cooled
  - iv. Phase change cooling technology
- (e) Identify the physiological and psychological stresses that can affect users of PPE.

**NFPA® 472, 6.2.4.1**

Demonstrate the ability to don, work in, and doff the equipment provided to support mission specific tasks.

- (1) Describe at least three safety procedures for personnel wearing PPE.
- (2) Describe at least three emergency procedures for personnel wearing PPE.
- (3) Demonstrate the ability to don, work in, and doff PPE.
- (4) Demonstrate local procedures for responders undergoing the technical decontamination process.
- (5) Describe the maintenance, testing, inspection, storage and documentation procedures for PPE, provided by the AHJ, according to the manufacturer's specifications and recommendations.

**NFPA® 472, 6.6.3.2**

Given PPE, select the PPE required to support product control at hazmat/WMD incidents based on local procedures.



## Key Points

### PPE Lessons Learned

- Toxic soot and carbon particulate become embedded in turnout clothing.
- Contaminants from turnouts can be absorbed or inhaled by fire fighters.
- Contaminants on turnouts can ignite and pose a threat to fire fighters.
- Turnout gear should be scheduled for regular maintenance and cleaning.
- Cleaning of PPE should be in accordance with the manufacturer's specifications.

## Determine Appropriate Personal Protective Equipment

The purpose of personal protective equipment (PPE) is to shield or isolate responders from the chemical, physical and biological hazards encountered during most routine fire fighting calls. The set of PPE normally available to first responders consists of structural fire fighting protective clothing (SFPC) and self-contained breathing apparatus (SCBA). This combination of equipment generally provides some protection against flame, heat and smoke, as well as limited protection from chemical and biological agents.

### Structural Fire Fighter Protective Clothing

Today, many fire and rescue departments order customized SFPC to match their own particular local needs. SFPC should be inspected for damage upon initial delivery and after each use. Cleaning and repairs should be performed according to manufacturer specifications.

For SFPC to provide its intended level of protection, it must be:

- Well fitting
- Regularly cleaned, maintained and repaired
- Donned and worn appropriately

A set of SFPC consists of a helmet, coat, pants, boots, gloves and a hood to cover parts of the head not protected by the helmet and face piece. The coats are generally made of three layers:

1. The outer layer provides durability, tear resistance and some thermal protection; it is typically reinforced with Kevlar and PBI.
2. The middle layer is usually made of water-proof material, to serve as a moisture/steam barrier.
3. The inner layer is designed for thermal protection only, and may be covered with Kevlar or Nomex.

**SFPC does not offer sufficient protection against toxic gases, most chemicals or radioactive materials; nor will it protect against very high temperatures.** These conditions require customized operating procedures and use of more specialized PPE than is typically available to fire fighters.

In order to make sound decisions regarding personal safety during emergency situations, it is imperative that first responders understand the appropriate use and limitations of structural fire fighter protective clothing (SFPC). When determining which level of protection is best for a given situation, the degree of hazard (or risk) and life-saving potential are key considerations.



SFPC is designed to provide personnel with limited thermal protection, and limited protection from the toxic by-products of combustion. SFPC is not designed to withstand direct flame impingement (contact). It is only capable of providing thermal protection from heat and toxic smoke situations routinely encountered by fire fighters.

**SFPC is constructed to provide limited protection from heat and cold, but is not designed to provide adequate protection from harmful vapors and liquids that can be produced during hazmat incidents. No layers or components of SFPC are designed to protect against chemicals.**

Per the DOT ERG, in cases where SFPC can be expected to reliably provide limited protection, the responder who is wearing SFPC along with SCBA may be able to perform a quick in-and-out operation (to attempt an immediate rescue or turn off a remote valve to control a leak, for example). The incident commander makes the decision for unit(s) to approach the hazard area if, and only if, potential benefits outweigh predicted risks.<sup>1</sup>



### Fires Create Their Own HazMats

Exposures can include:

- ▶ Smoke and particulate matter
- ▶ Carbon monoxide
- ▶ Nitrogen cyanide
- ▶ Sulfur dioxide
- ▶ Acrolein
- ▶ Formaldehyde and acetaldehyde
- ▶ Benzene and many other organic chemicals
- ▶ Arsenic pentoxide (from treated wood)

Many of these exposures cause acute effects, but others may cause chronic effects such as respiratory health problems and decreased lung function from repeated exposures to diesel exhaust, benzene, polycyclic aromatic hydrocarbons, asbestos or formaldehyde.

### NIOSH Recommends:

- ▶ Wear appropriate PPE at all incidents.
- ▶ Wear and activate the PASS device.
- ▶ Check your SCBA to assure it is in good working order and has been properly maintained.
- ▶ Use a buddy system whenever wearing SCBA.
- ▶ Have radio communication capability.

Source: National Institute for Occupational Safety and Health. Summary of Health Hazard Evaluations, NIOSH Publication No. 2004-115 (January, 2004). <http://www.cdc.gov/niosh> (retrieved July 10, 2013).

<sup>1</sup> ERG, page 361.





## Limitations of SFPC

In most cases, SFPC is the only protection available to fire fighters even though they respond to various kinds of incidents. SFPC may not be sufficiently protective for either initial or extended use at many emergency scenes.

Safe and successful use of SFPC depends on heeding known limitations, gaining proper training and using safe work habits. Known limitations include:

- SFPC is easily permeated or penetrated by most hazardous chemicals which may enter through closures, rips or tears, or get trapped under overlapped clothing.
- Direct contact with sunlight and chemicals—including splashes or soaking—may result in serious exposure by way of direct skin contact.
- SFPC is not tested against chemicals, so it cannot be expected to provide reliable protection from chemical exposure.
- It is virtually impossible to assure adequate decontamination and subsequent integrity of garments without sophisticated laboratory testing.
- Hardware and closure systems may fail or malfunction.
- Repeated chemical and heat exposure may lessen material strength, cause component failure and reduce the usable lifetime and protective qualities of a garment.
- Repeated use of contaminated SFPC results in chronic exposure to the wearer.



## Sample Personal Protective Equipment Inspection Checklist

### SCBA

- Check that all connections are tight.
- Check materials (including harness and straps) for pliability, signs of deterioration and signs of distortion or color changes; this may indicate exposure to high heat.
- Check for proper setting and operation of regulators and valves (according to manufacturers' recommendations).
- Check that cylinder is securely fastened to pack/holder and is full.
- Check hydrostatic test date for bottle (five years for a steel cylinder, three years for a composite).
- Check operation of alarm(s); check PASS device if attached to SCBA.
- Examine faceshield and lenses for cracks and fogginess.
- Inspect SCBA daily or at shift change; before and after each use; at least monthly when in storage; every time they are cleaned.

### Coats and Trousers

- Examine outer shell, liner materials, wristlets, collars and hoods for evidence of damage or contamination or color change. Color change may indicate exposure to high heat.
- Contamination includes soiling, stains, discoloration and deterioration.
- Physical damage includes tears, cuts, punctures and abraded areas.
- Thermal damage includes brittleness, charring, stiffness and melted areas.
- Check stretch recovery of hood and wristlet materials.
- Examine condition of all seams; looking for loose stitching or lifted tape of moisture barrier seams.
- Examine hardware (snaps, hooks and loops, zippers) for signs of corrosion.
- Examine trim for loss of luster, abraded areas and evidence of melting.

### Helmets

- Examine shell for discoloration, pitting, separation, impact/puncture damage and melting.
- Examine faceshield for scratches, cloudiness and evidence of melting.
- Examine retention/suspension system for discoloration, evidence of thermal damage and physical defects.
- Examine trim for loss of luster, abraded areas and evidence of melting.
- Check correct operation of chin strap.

### Gloves

- Examine outer shell, liner materials and wristlets for evidence of damage and contamination.
- Examine condition of all seams, looking for loose stitching or lifted tape of moisture barrier seams; check to ensure that liner has not separated from outer shell.

### Footwear

- Examine boot outer and liner materials for evidence of damage and contamination.
- Examine condition of soles for punctures, cuts or embedded items (e.g., nails).
- Examine hardware (e.g., eyelets, stud posts, zippers) for signs of corrosion.



## **PASS Devices**

Personal Alert Safety Systems (PASS) serve as fire fighter motion detectors and emergency alarms. They emit a high pitched audible alarm when a fire fighter remains motionless for an extended period of time, or if the wearer manually activates the alarm, signaling being lost, trapped or injured.

Because they are designed to protect and enhance occupational safety and health, OSHA regulates these devices, and NFPA® has adopted standards on their use.

NFPA® requires that the latest generation of SCBA units include an integrated PASS that activates upon the complete loss of air supply. Many fire departments require both the integrated system (with SCBA), as well as the stand-alone unit be attached to the fire fighter's coat in case the SCBA is removed before he or she becomes incapacitated.



## Respiratory Protection

Inhalation is a major route of chemical exposure. Fire fighters require protection from toxic products of combustion, as well as from other hazmats that may be present at the emergency incident. Protection of the respiratory system is critical to the survival of fire fighters when operating in a hazardous atmosphere. Therefore, respirator use, care and maintenance are strictly regulated by government and industry standards.

There are three types of respirators typically available for use:

1. Positive Pressure Self-Contained Breathing Apparatus (SCBA)
2. Supplied Air Respirator (SAR)
3. Air-Purifying Respirator (APR) and Powered APR (PAPR)

Fire fighters use positive pressure self-contained breathing apparatus (SCBA) as the only means of protecting their respiratory systems when responding to emergencies. While there are other types of respirators that general industry employs, only those units supplying a constant flow of air inside a mask are approved for use in IDLH atmospheres.

SARs and APRs are primarily used by industry, so they have limited use in emergency operations. SARs have supply lines that restrict movement and are limited to 300 feet from the air source.

Air-purifying respirators depend on a normal level of oxygen in the atmosphere, as well as ambient temperature. They also require chemical-specific cartridge filters. Powered air-purifying respirators (PAPR) are air-purifying respirators that use a blower to force the ambient air through air-purifying elements to the inlet covering. The airflow is normally much higher than the wearer needs to breathe, and the excess flow creates a positive pressure as it passes through the mask. This pressure pushes air out, and keeps contaminants from leaking in. The protection factor for a PAPR is 1,000, whereas the protection factor for an SCBA is 10,000.

Particulate respirators protect the user from particulates. These filters may be used with half face piece masks. The criteria for use are set by NIOSH.



SCBA maintains positive pressure in the face piece at all times.



## Self-Contained Breathing Apparatus (SCBA)

SCBA consists of a face piece connected by a hose to a regulator carrying air. The apparatus provides positive pressure to the user, and offers protection against many types and levels of airborne contaminants.

## Supplied Air Respirator (SAR)

SARs provide positive pressure, full face piece protection without a supply cylinder and harness assembly. These respirators reduce or eliminate some of the constraints and physiological stress sometimes associated with conventional SCBA. A high pressure hose line from a remote source provides an almost limitless, uninterrupted supply of breathing air. The unit can be re-supplied by gradually switching to full bottles while others are being refilled.

## Air-Purifying Respirators (APR) and Powered Air-Purifying Respirators (PAPR)

Air-purifying respirators have limitations in emergency response. Cartridges on the respirator mask filter contaminants in the environment, but there is no supply of fresh air. If the environment is oxygen-deficient, then the air taken through the mask is oxygen-deficient as well. This could be extremely hazardous in an environment where oxygen is being displaced or consumed, as in combustion. Also, the user must know the type and concentration of material present in order to select the appropriate cartridge for the atmosphere.

The air we breathe is composed of 20.9% oxygen. APRs and PAPRs are useful in environments in which the oxygen is in the normal range. These specialized respirators should only be used in conjunction with monitoring devices. These devices depend on the hazmats being identified before use so that the appropriate cartridge can be selected and the measured concentration can be analyzed.

APRs and PAPRs are NOT capable of providing protection in an IDLH or low oxygen environment; they provide no additional oxygen to the wearer.



Powered Air-Purifying Respirator (PAPR): provides specific protection against known chemicals in a normal oxygen environment



## Advantages of SCBA

- Provides respiratory protection
- Provides untethered access to nearly all portions of an emergency scene

## Limitations of SCBA

- Decreases worker mobility (particularly in confined areas) due to bulk and weight
- Limited air supply
- High temperatures can compromise effectiveness

## Advantages of Positive Pressure SAR

- Provides extended operational periods
- Reduced weight and profile increase ability to move around with decreased physical stress
- Provides the same protection against airborne contaminants as conventional SCBA

## Limitations of Positive Pressure SAR

- OSHA/NIOSH regulations limit SAR supply hose to no more than 91 meters (300 feet) from the air source
- OSHA/NIOSH-approved emergency response SARs must include a five-minute emergency egress supply system
- Hose line may get tangled and impair mobility
- Hose line is subject to damage or degradation by physical or chemical hazards
- Egress or escape may be hampered by having to retrace steps to follow airline
- Requires supervision/monitoring of the air supply line (additional staffing)
- Not appropriate for use in emergency response because the air line may become damaged, or may prevent the responder from exiting the area using the safest route





## Inspecting Personal Protective Equipment

An effective PPE inspection program should include five different inspections. All five types of inspections should be conducted as a matter of routine.

You must also conduct any SCBA inspections mandated by law (e.g., periodic cylinder testing). Each inspection covers different areas with varying degrees of depth. Personnel responsible for PPE inspection should follow inspection procedures suggested by the manufacturer. Damaged or deteriorated PPE must be assessed for either replacement or repair.

### PPE Inspections

1. Inspection and operational testing of equipment when it is received from the factory or distributor
2. Inspection of equipment as it is selected for a particular response activity
3. Inspection of equipment after use or training, and prior to maintenance
4. Periodic inspection of stored equipment
5. Periodic inspection when a question arises concerning the appropriateness of selected equipment, or when problems with similar equipment are discovered



## Other Levels of Protection

### Level A Protection

Level A protection affords the highest level of both respiratory and skin protection.

The NFPA standard for Level A protective garments is **NFPA® 1991, Standard on Vapor-Protective Ensembles for Hazardous Materials Emergencies**. Compliant garments will have a label on the inside of the suit stating that it is compliant. The suit will also come with a chart that lists the chemicals the garment protects against, and how quickly it will be weakened. As with other types of PPE, remember that there is no one garment style or material that can protect against all types of chemicals.

Indications for use of Level A protection:

- Highest level of respiratory protection is needed (SCBA or SAR with escape pack)
- Highest level of skin protection is required (skin-absorbable materials)
- Highest level of eye protection is required (obtained by wearing SCBA face piece)
- Constant high concentration exposure (offensive work activities such as plugging/patching)
- Suspected or confirmed carcinogens
- Vapor hazard is present



### Level A Advantages

- ▶ Can virtually eliminate possibility of contact with environmental hazards (provides its own environment)
- ▶ Best protection known at this time

### Level A Limitations

- ▶ Bulky—requires manpower to don and doff
- ▶ Physically stressful—no cooling or heating
- ▶ Psychologically stressful (confinement)
- ▶ Work duration limited due to heat
- ▶ Reduced mobility and dexterity increases response time
- ▶ Communication may be difficult
- ▶ Will not survive fire conditions



### Level B Advantages

- ▶ High level of respiratory protection
- ▶ Increased mobility/dexterity (theoretically)
- ▶ May be cooler
- ▶ Compliant garments have good penetration resistance

### Level B Limitations

- ▶ Not gas/vapor tight—not designed to protect from vapors/gases
- ▶ Not designed or tested (NFPA 1992) to be used at scenes involving carcinogens or skin absorbable chemicals
- ▶ Offers no thermal protection

## Level B Protection

Level B protection affords the user the highest level of respiratory protection, and protection against contact with product from spills and splashes. This level of protection should never be used when there is a possibility of contact with a dangerous vapor/gas.

The NFPA® standard for Levels B and C protective garments is **NFPA® 1992: Standard on Liquid Splash-Protective Ensembles for Hazardous Materials Emergencies** (2010 Edition). Tests done on NFPA® 1992 suits are for penetration, not permeation. The standard was written to stipulate construction for splash resistance in order to guard against liquid leaks through seams, closures and attachments, rather than through the clothing material itself. This is a critical issue to understand. The standard also eliminated testing for protection against chemicals in gas form, those considered to be a hazard by skin contact or absorption, and those with a history of being carcinogenic.

Level B suits may be encapsulating or non-encapsulating.

Indications for use of Level B protection:

- The highest level of respiratory protection is necessary, but a lesser level of skin protection is needed
- Probable exposure to low concentrations—incidental splash
- Chemical is mainly a respiratory hazard



Encapsulating Level B Suit



Non-Encapsulating Level B Suit



## Level C Protection

Level C protection illustrates the difference between NFPA® and EPA requirements for protection. The EPA stipulation is the same with respect to splash protection for both Levels C and B suits. However, EPA's requirement for Level C respiratory protection is less stringent than that for Level B. Compliance with EPA standards for Level C only requires air-purifying respirators.

By contrast, NFPA®'s Level C requirements include the use of APRs but add garment specifications not required by EPA. Although EPA and NFPA® have different requirements for protective features of Levels B and C clothing, they both aim to provide protection against hazards that are identifiable and measurable as insignificant exposure hazards, regardless of state.

Indications for use of Level C protection:

- Reduced level of respiratory protection needed
- Well characterized and measured products
- Splashes or incidental contact with product will not cause harm to skin, or be absorbed



Level C garment with full face and respiratory protection provided by an air-purifying respirator

### Level C Advantages

- ▶ Reduced respiratory stress (both physical and working time) because of PAPR/APR use
- ▶ Tested against limited penetration and liquid integrity
- ▶ Light weight, less physical stress
- ▶ More comfortable
- ▶ Designed to be disposable (no reuse testing required)

### Level C Limitations

- ▶ Can only be used in very controlled situations
- ▶ No flammability rating—no flash protection
- ▶ Reduced strength from typical Level B
- ▶ Requires oxygen-sufficient atmosphere



### Level D Advantages

- ▶ Allows for more efficient work activities around mechanical hazards

### Level D Limitations

- ▶ Provides no chemical protection
- ▶ Provides limited thermal protection
- ▶ Provides no respiratory protection

## Level D Protection

EPA regulations for Level D protection, and NFPA® guidelines for station uniforms, address normal workplace protections. Level D protection is much more commonly used in routine industrial operations than in the fire service. Different workplace environments and varying work activities require different protective clothing/equipment. There is no NFPA® standard for Level D garment construction.

Features of Level D protection:

- Eye protection
- Boots/shoes that are steel-toed, with shanks
- Hard hat
- Gloves

Indications for use of Level D protection:

- Atmosphere contains no known chemical hazard
- Work activities preclude splashes, immersion or the potential for unexpected inhalation or contact with hazmats



Level D protection is designed for chemical process industry workers for day to day operations.





## High Temperature Protective Clothing

Two types of high temperature protective clothing are designed for specific thermal environments in which specialized response teams work:

### Proximity Suits

Proximity suits are designed for exposures of short duration and close proximity to flame and radiant heat, such as an aircraft crash fire requiring rescue operations. The outer shell is a highly reflective, aluminized fabric over an inner shell of a flame-retardant fabric. These ensembles are not designed to offer any substantial chemical protection.

Proximity suits are available as a separate coat and pants ensemble or as coveralls. In either case, a hood must be used. The outer shell must be kept clean to ensure maximum reflection of radiant heat. The outer shell of aged suits will commonly begin to crack or flake off after several years of regular use. At this point, the protection factor drops significantly, and the suit should be replaced. Older proximity suits may incorporate loose asbestos fibers in their design. Because of the asbestos hazard, they should be bagged and properly disposed of.

### Fire Entry Suits

Fire entry suits offer complete, effective protection for short duration entry into a total flame environment. They are designed to withstand exposures to radiant heat levels up to 2,000°F. Entry suits consist of a coat, pants and separate hood assembly. They are constructed of several layers of flame-retardant materials; the outer layer is often aluminized.

Entry suits are useful for accomplishing operations such as valve shutdowns in a flammable gas or liquid facility. However, there is a lack of mobility and flexibility when attempting these manipulations. Fire entry suits are usually a low priority item for most fire departments and hazmat response teams.



Fire entry suits are garments which provide significant thermal protection for short-term entry into extremely hot areas.





### PPE SAFETY ALERT

Air supply management is the most critical safety element of an entry operation. Work mission duration should be based upon the following:

- ▶ Entry Time
- ▶ Exit Time
- ▶ Decon Time
- ▶ Safety Factor
- ▶ Work Time

#### **Stay alert!**

A 30-minute bottle provides an average working time of 20 minutes to most wearers. A 60 minute bottle provides about 40 minutes. Plan accordingly!

## Safe Practices for PPE Selection and Use

### Entry and Backup Teams

Before approaching a hazmat incident, analyze the problem. You should survey the scene from a safe distance or use binoculars to assess the hazards, collect hazard information and determine the appropriate PPE. Whenever possible, you should approach a hazardous materials incident from upwind and uphill. Your approach should be carefully calculated.

Due to the hazards associated with the use of PPE at hazmat incidents, use of buddy systems and backup personnel are mandated by NFPA® and OSHA standards. A **buddy system** is a system of organizing personnel into workgroups in such a manner that each member has a buddy or partner. This eliminates the risk of any single member working alone.

Backup personnel shall be assigned to stand by, in a state of readiness, to provide assistance or rescue, if needed. A response team working within the hazardous area must have at least two members in that team. The minimum number of personnel necessary for performing tasks in the hazardous area is four—two working in the hazard area itself and two standing by as backup. Backup team members must be dressed in the same level of PPE as entry personnel.

Additional safety precautions for entry and backup teams include:

- Staying uphill, upwind, upstream of hazmats
- Minimizing contact with any hazards
- Monitoring yourself and your buddy for signs of cold- or heat-related illness which may result from wearing PPE in a hazardous environment
- Maintaining accountability as per the AHJ
- Ensuring proper communications per the AHJ
- Ensuring knowledge of evacuation and escape procedure plan
- Performing medical monitoring before entry in protective clothing, as well as after leaving the contaminated area. Medical monitoring should include blood pressure, respirations, pulse and core body temperature.
- Complying with any other SOP/SOG requirements as listed by AHJ

### Safety Precautions

Any entry into the hot zone at a hazardous materials/WMD incident should be considered a life safety risk to the responders. In order to ensure an all inclusive risk evaluation, consider the following operational issues and safety procedures when using PPE at hazmat incidents.

Don't think of PPE as your first line of defense; consider it as the last line of defense that comes into play if your selection of tactical objectives and site safety procedures can't keep the hazards off you.



Chemical protection and thermal protection are, for all practical purposes, mutually exclusive. While some chemical protective ensembles offer flash protection, the actual thermal protection should be considered to be very minimal.

Decontamination operations should be established prior to entry operations into the hot zone.

Always minimize any direct contact with any chemical, no matter your level of protection. Avoid walking into or touching substances whenever possible.

Ensure that entry and backup crews have equivalent levels of protection. Train, prepare and equip your backup teams as Rapid Intervention Team (RIT) capable. This is especially true when responders are operating inside structures where step climbing, entry in enclosed areas, or long distance entries are a necessity. If needed, additional backup personnel should be available and rapid response ready if risk analysis deems it necessary.

Entry personnel must maintain their situational awareness at all times. Take a 360 degree look around where you are working to evaluate risks and identify alternate exit strategies.

Maintain communications at all times. Entry team members should know the basic hand signal procedures used in their jurisdiction (e.g., the waving of raised hands to signal an entry team member is in distress; a thumbs up to indicate progress). A specific channel should be assigned to entry personnel with backup, safety and hazard sector listening. Only the hazard sector officer should be talking to the entry personnel during the operation.

## Emergency Procedures When Wearing CPC

Response organizations should develop procedures to address the following scenarios involving entry teams working in hot zone areas:

- Loss of air
- Loss of suit integrity
- Loss of communications
- Buddy down in the hot zone
- The need to evacuate the hot zone

Each of the emergencies listed above may pose a significant life safety threat. Each jurisdiction should have SOPs/SOGs for the safe and rapid response to these events. This may include notifying the entry team leader or safety officer, and exiting the hot zone as quickly as possible. Training should be developed to deploy RIT backup members in order to ensure proper deployment and potential removal of entry team members.

## Selecting and Wearing CPC



As with any emergency response, a hazard assessment will guide you toward your response objectives, and the equipment necessary to execute those objectives. To begin a hazard assessment, answer the following questions:

- What is the material involved?
- What is its quantity?
- How can it harm us?
- What should we do about it?
- What is necessary to protect us?
- Do we have the necessary equipment?

### **Level of Protection Needed**

If you decide to enter the hazard zone, you must first decide what level of protection is necessary. Indications for use of various levels of protection were discussed earlier in this lesson. If the product is a vapor or skin contact hazard because of its toxicity and chemical properties, or if responders will enter a closed area where there may be an unknown hazard, select Level A protection. If meter readings or other clues indicate the possibility of an unchangeable flammable atmosphere, you may also need some type of flash protection. Use Level B/C protection when the criteria for Level A are not met and only a chemical splash hazard (not immersion) may exist.

### **Required Actions**

Your work activities directly affect the level of protection you need. For example, a quick in-and-out rescue mission will involve contact with the victim who may or may not be contaminated, and possibly with the hazardous product. Damming, diking and diversion may also result in contact with the product, while vapor dispersion or suppression may be performed without coming in contact with the product.

### **Product Properties**

The physical and chemical properties of a product determine its health effects on responders. For example, products with low vapor pressures normally do not generate large amounts of vapor into the atmosphere.

### **CPC Properties**

Even if the proper level of CPC is available, you should know whether the garment has sufficient chemical resistance for the likely contact and exposure. That is, will the garment protect you for the duration of your mission and through decontamination? You can answer these questions using the chemical compatibility charts and product properties.



## Chemical Resistance/Compatibility

Level of protection (A, B, C, D) relates to a garment's style. Chemical resistance or compatibility is dependent on the material used in the construction of the garment. This is commonly referred to as **chemical compatibility** and is used to determine how much resistance a material has to attack by specified chemicals. Always remember that no single material offers protection against all chemicals, and to some extent, all materials will allow chemicals to pass through, given enough time.

### Factors That Affect Chemical Compatibility

There are three principal manners by which chemical protective clothing material can be compromised: penetration, degradation and permeation.

#### Penetration

Penetration is **the movement of a chemical through existing openings in a material or garment**. Simply put, it is a leak. Consider the following as it relates to penetration:

- Chemical may pass through physical openings in the garment.
- Garment construction is the main factor in penetration.
- Zippers, seams, stitching, pass-through openings, relief valves, glove and boot connections are all areas where penetration may occur.
- Loose weave materials may allow greater penetration.
- Abrasion or creasing may lead to pinholes or cracks in materials.

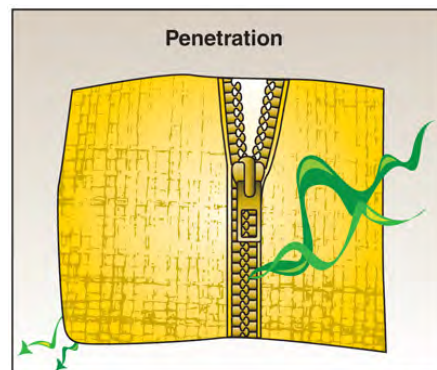

#### Degradation

Degradation refers to an actual **observable or measurable change in a material caused by contact with another agent**. Consider the following as it relates to degradation:

- Material is actually changed or degraded by the chemical.
- Look for visible signs—charring, softening, shrinking, cracking and dissolving.
- Sunlight or other ambient conditions may degrade materials.

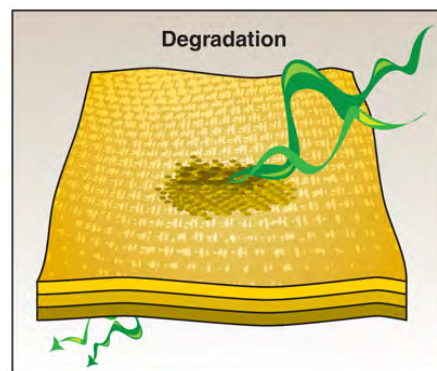

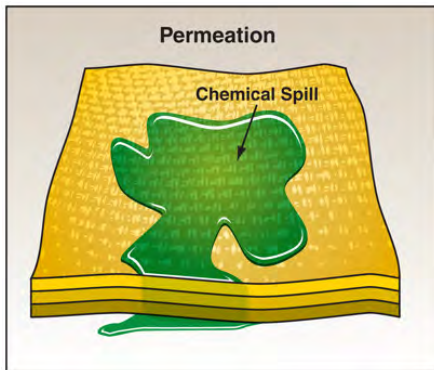

## Permeation

Permeation is perhaps the most insidious manner in which chemical protective clothing can be compromised. It refers to **the movement of a chemical through a material on the molecular level**. In most cases, there are no visible signs that the process is occurring. Consider the following as it relates to permeation:

- Chemicals contact the outside of material as absorption occurs.
- There is a higher concentration outside of the material than inside.
- During permeation, the chemical is pushed through the material towards lower concentration by molecular pressure.
- As the chemical reaches the inside of material, adsorption occurs.
- In general, the higher the temperature, the faster the permeation.
- High concentrations of chemicals permeate faster than lower concentrations.
- Mixtures of chemicals can permeate faster or slower than the constituent chemicals.
- Permeation can be prevented with the proper use of chemical compatibility charts.



## Hazards Encountered During Entry

Always check the chemical compatibility of all protective clothing items to be used during entry. The use of permeation charts for selection of chemical protective clothing is a skill that requires practice and familiarity with both compatibility charts and garments available. It also requires the ability to predict actual or likely exposure levels and concentrations. The following chart depicts the potential hazards present at an emergency scene using the TRACEM hazard system.

### TRACEM Hazard Index for PPE Selection

Hazard	Clothing	Respiratory
Thermal	<ul style="list-style-type: none"> <li>SFPC</li> <li>Proximity clothing</li> <li>Chemical Vapor PPE w/liquified gas over cover (Level A flash ensemble)</li> </ul>	<ul style="list-style-type: none"> <li>SCBA</li> <li>SAR</li> </ul>
Radiation	<ul style="list-style-type: none"> <li>SFPC</li> <li>Chemical Splash PPE (Level B/C ensemble)</li> <li>Radiological clothing</li> </ul>	<ul style="list-style-type: none"> <li>SCBA</li> <li>SAR</li> <li>APR</li> <li>PAPR</li> </ul>
Asphyxiant: simple	<ul style="list-style-type: none"> <li>Chemical Vapor PPE (Level A suit ensemble)</li> <li>Chemical Splash PPE (Level B/C ensemble)</li> </ul>	<ul style="list-style-type: none"> <li>SCBA</li> <li>SAR</li> </ul>
Chemical vapors	<ul style="list-style-type: none"> <li>Chemical Vapor PPE (Level A suit ensemble)</li> </ul>	<ul style="list-style-type: none"> <li>SCBA</li> <li>SAR</li> </ul>
Chemical liquids	<ul style="list-style-type: none"> <li>Chemical Splash PPE (Level B/C ensemble)</li> </ul>	<ul style="list-style-type: none"> <li>SCBA</li> <li>SAR</li> </ul>
Etiological (biological)	<ul style="list-style-type: none"> <li>Chemical Splash PPE (Level B/C ensemble)</li> </ul>	<ul style="list-style-type: none"> <li>SCBA</li> <li>SAR</li> <li>APR</li> <li>PAPR</li> </ul>
Mechanical (explosives)	<ul style="list-style-type: none"> <li>Specialized Bomb Suits</li> </ul>	<ul style="list-style-type: none"> <li>SCBA</li> <li>SAR</li> <li>APR</li> <li>PAPR</li> </ul>





## Stresses of Wearing CPC

### Heat Related Stress

The body will attempt to maintain an appropriate temperature (97°-100°F). Covering the body with impermeable material such as chemical protective clothing, and performing strenuous work, will interfere with the body's ability to regulate temperature.

Personnel who wear chemical protective clothing should maintain a high level of fitness and hydration, and pass a pre-entry medical screening before being permitted to don chemical protective clothing.

### Types of Heat Related Stress

#### Heat Cramps

When working in chemical protective clothing, look for the following symptoms of heat cramps.

- Painful, intermittent cramps or spasms in the back, legs, arms, stomach
- Heavy sweating
- Variable pulse
- Variable respiration

The appropriate treatment for heat cramps is to:

- Stop work activities
- Re-hydrate
- Have EMS evaluate your condition.

#### Heat Exhaustion

When working in chemical protective clothing, look for the following symptoms of heat exhaustion.

- Profuse sweating
- Rapid, shallow respiration (panting)
- General fatigue, nausea, vomiting, slow weak pulse, cool, pale, clammy, pounding heart
- Thirst
- Headache, dizziness
- Poor judgment, irritability

To prevent heat exhaustion:

- Drink plenty of water.
- Rest, whenever possible, in shade or cool area.
- Wear only what is necessary.
- Monitor yourself and others.
- Have EMS monitor your condition.



## Heat Stroke

Heat stroke is a true medical emergency and a life-threatening condition. It is a result of unrecognized and untreated heat exhaustion. When working in chemical protective clothing, look for the following symptoms of heat stroke.

- Red, hot, dry skin—no sweating
- Strong, rapid pulse
- Significant change in level of consciousness and possible coma
- Core body temperatures of >104.5°F

The appropriate treatment for heat stroke is:

- Removal from area
- Removal of impermeable clothing
- Immediate EMS evaluation and treatment

## Preventing Heat Related Stress

A pre-donning physical evaluation and proper hydration are the best methods to ensure that heat related stresses do not compromise an emergency operation. Realistic work times, close supervision and monitoring will help maintain the health status of entry personnel.

## Cooling Devices

Cooling devices help reduce heat build-up in impermeable clothing. **Air cooling systems** use ambient temperature or cooled air supplied by a hose line into the impermeable suit. **Ice cooled systems** use vests around the torso filled with ice to help remove heat from the user. **Water cooled systems** are similar to ice systems, but use water filled vests to assist in heat transfer.

**Phase change cooling systems** also provide heat related relief to suit-wearing responders. Currently used by the United States military, these vests have proven their effectiveness in preventing heat stress. Simply freeze the reusable phase change cooling inserts and place inserts in inner pouches of vests. Phase change material releases temperature-specific cooling relief to protect workers in high heat environments. Gel packs remain flexible when frozen so responders can move without restriction.

Remember that these systems will add weight. The additional weight and associated decrease in mobility may cause increased stress and heat production. Recent information shows that these types of systems may not cool or reduce core temperatures, but may instead give the user a cooling sensation on the surface. This feeling may give the user a false sense of well-being. In the initial phases of hazmat response, cooling systems were very popular, but many teams have discontinued their use because of the increased weight, unknown efficiency, increased cost and increased maintenance. The work activity duration may also be limited by the capacity of the cooling system.



## Cold Related Stress

Cold weather also causes additional problems for responders, including more slip hazards and access problems. Chemical protective clothing is usually not a good insulator. Although it does prevent your body from using normal cooling techniques, it also allows heat transfer to take place. In a cold ambient environment, you and your chemical protective clothing will be warmer than the surrounding atmosphere. You will lose heat as it radiates from your suit to the environment.

### Types of Cold Related Stress

Cold related injuries usually are progressive. They start at the peripheries (fingers, toes, hands, feet, ears) and spread inward, lowering core temperature.

#### Frostnip (Incipient Frostbite)

When working in chemical protective clothing, look for the following symptoms of frostnip.

- Sudden whitening of skin
- Some discomfort
- Easily treated, damage not permanent

#### Superficial Frostbite

When working in chemical protective clothing, look for the following symptoms of superficial frostbite.

- Waxy or white skin surface
- Underlying tissue is still resilient

Superficial frostbite is treatable, and usually results in no permanent damage

#### Deep Frostbite

When working in chemical protective clothing, look for the following symptoms of deep frostbite.

- Cold pale skin
- Underlying tissue is solid

The treatment of deep frostbite is difficult, and results in permanent damage.



## Hypothermia

Hypothermia is a systemic problem resulting from a lowered body temperature. Hypothermia progresses from shivering to apathy, listlessness and sleepiness, to slowed pulse and coma-like respiration, to freezing of extremities, and finally to death.

## Preventing Cold Related Stress

Preparing for cold weather operations is paramount. Wearing appropriate undergarments for cold weather will help you reduce effects of the cold. A warm environment (buses, command vehicles, portable structures, nearby structures, etc.) for briefing, donning, decontamination and doffing, will also help minimize cold injuries. Give primary consideration to personnel removing chemical protective clothing because they will still be wet from perspiration, and exposure to cold ambient air will cause a sudden decrease in body temperature.

## Other Stress Characteristics of PPE

Besides the physiological stresses just discussed, psychological stress during the wearing of chemical protective clothing must be evaluated. Many responders who wear chemical protective clothing that is fully encapsulating respond to the experience with some level of claustrophobia. Even if personnel have no problems with structural fire fighting clothing and SCBA, the additional confinement of encapsulating or impermeable garments, along with the loss of peripheral vision, dexterity and movement, may be significantly limiting, and thus overwhelming.

Entry team members in chemical protective clothing also know they will be entering an area where a dangerous chemical exposure may occur. This knowledge may be discomfoting to some personnel.

Psychological stresses can be prevented through adequate training, practice and experience. The more confidence you have in your equipment, procedures and skills, the more confidence you will have entering a hazard zone. However, some personnel, especially those with claustrophobia, will not be able to tolerate chemical protective clothing, and may not be suited to these activities.



## Maintaining Chemical Protective Clothing

NFPA® requires maintenance, testing and record-keeping for chemical protective clothing and equipment. Manufacturers also require that extensive records be kept for garments purchased from them.

It is also just good sense to know what your clothing has been exposed to, when it was exposed, how it was cleaned/disinfected, when it was tested, etc. Fire service responders are familiar with testing of fire equipment.

Hoses, pumps, ladders, SCBA, PASS devices and other equipment are all operationally tested to ensure they will perform properly when needed. The same is true of chemical protective clothing and equipment. Each authority having jurisdiction is responsible for the maintenance of its chemical protective clothing inventory. Members who are required to use chemical protective clothing are required to examine their local department's SOPs/SOGs to ensure proper compliance.



## Lesson 3.3 - Decontamination

### Lesson Objectives<sup>1</sup>



#### NFPA® 472, 5.3.4

Given scenarios involving hazmat/WMD incidents, identify when decontamination is needed.

- (1) Identify ways that people, PPE, apparatus, tools and equipment become contaminated.
- (2) Describe how the potential for secondary contamination determines the need for decontamination.
- (3) Explain the importance and limitations of decontamination procedures at hazmat incidents.
- (4) Identify the purpose of emergency decontamination procedures at hazmat incidents.
- (5) Identify the methods, advantages and limitations of emergency decontamination procedures.

#### NFPA® 472, 5.4.1(4)

Demonstrate the ability to perform emergency decontamination.

#### NFPA® 472, 6.2.4.1 (4)

Demonstrate local procedures for responders undergoing the technical decontamination process.

#### NFPA® 472, 6.6.4.2

Describe local procedures for going through the technical decontamination process.

<sup>1</sup> NFPA 472® Standard for Competence of Responders to Hazardous Materials/Weapons of Mass Destruction, 2013 Edition.





## Emergency Decon

### Advantages

- ▶ Readily available
- ▶ Quick for life saving
- ▶ Minimizes exposure time
- ▶ Helps prevent secondary contamination

### Disadvantages:

- ▶ Not always completely effective
- ▶ Privacy may be difficult to arrange and achieve

## Decontamination Issues

Decontamination procedures provide an organized process, a series of sequential steps, to reduce contamination.

Decontamination strategies need to be applicable to a wide variety of environments, and modifiable during inclement weather. Local standard operating procedures for decontamination, including alternative options, should be developed and practiced in cooperation with other affected organizations, such as hospital emergency departments.

Fire fighters routinely perform decontamination of their own clothing and equipment from fires and medical calls. Decontamination of civilians and unprotected responders can become warranted for a variety of reasons in emergency situations, such as preventing severe injury or loss of life, and eliminating the possibility of transferring contamination between people, equipment and vehicles.

First responders should use handlines in conjunction with master streams set on a wide fog pattern at low nozzle pressure, to provide a large amount of water for emergency decon of groups. To further guard against secondary contamination, clothing that has been contaminated and undergone emergency decontamination should be placed in plastic bags for further decontamination and/or disposal at a later time.

For protective purposes a decontamination area must be located some distance away from the scene—away from potential exposure—**as soon as possible**. Nobody (including EMS transport patients) should be allowed to leave a scene that is suspected of being contaminated, until they are decontaminated.



During emergency decontamination, contaminated run-off is of less concern, although it should be collected as soon as practical.



## Decontamination Guidelines

Generally speaking, outer, more heavily contaminated items (e.g., outer boots, gloves) should be decontaminated and removed first, followed by decontamination and removal of inner, less contaminated items (e.g., jackets, pants).

All equipment used for decontamination must also be decontaminated and/or disposed of properly. Buckets, brushes, clothing, tools and other contaminated equipment should be collected, placed in containers and labeled. An attempt should be made to collect and dispose of spent solutions and wash water.

Important things to remember about decontamination include:

- Visible, dry contaminants should be removed with a brush, rags or gauze.
- Removal of clothing, in many cases, will reduce a large portion of contaminants from coming into contact with the body; however, privacy must be insured.
- Affected skin and mucous membranes (including the eyes) should be flushed with water.
- When multiple areas of the body are affected, priority should be given to particularly vulnerable areas, such as the eyes.
- Large amounts of water must be used when corrosives are involved.
- Start at the top, have victims remain standing yet bent over for hair washing, then proceed downward.
- Medical personnel and receiving hospitals should be advised, prior to the transport of victims, of the possibility of contamination. This will allow the facilities to implement their decontamination procedures.

In some instances, it might be most appropriate to remove clothing before—rather than after—flushing. The extent and type of contaminant determines the proper sequence for decontamination steps.



## Typical Progression of Steps to Perform Decontamination on Responders

### When in the Decontamination Area

1. Keep SCBA on, and in use.
2. Brush off heavy particles of material.
3. Use a low pressure fog line to rinse SFPC, from the top down.
4. After thoroughly rinsing, step into the clean area.

### When in the Clean Area

Remove SFPC—**Make sure to remove SCBA face piece last.**

### Once Back at Quarters

Once you are back at the station, you should perform the following.

- Take a shower.
- Don a clean uniform.
- Clean and inspect your SFPC and SCBA.
- Complete an exposure form.
- Clean or dispose of dirty uniform, as appropriate.



## Emergency Decontamination (Performance Checklist A-33)

Emergency decontamination is a hazmat response skill that all first responders must master. Your jurisdiction should have a standard operating procedure and/or guideline (SOP/SOG) related to emergency decontamination at a hazardous materials/WMD incident. The general procedure, on the opposite page, should be followed when performing emergency decontamination.



During the analysis phase, responders should determine the physical properties and hazards of the materials involved. Next, determine the viability of the victim by observation and calling out. If the victim is not visible from a safe distance, find out when the person was last seen or known to be conscious. Also determine how long the victim has been trapped or exposed to the hazmats/WMDs, and whether the victim is trapped or if there is debris around the victim.

Remember, responders in SFPC with SCBA may be able to perform a quick in-and-out rescue or operation such as turning off a remote valve—if the potential benefits outweigh the predicted risks. If emergency decontamination is warranted, it must be completed quickly and effectively, in accordance with local SOPs/SOGs. If an EMS unit was not automatically dispatched at the start of the incident, it should be requested to be available following emergency decon.

Throughout the decontamination process, responders must use the proper PPE, along with safe work practices, to minimize the risk of injury or contamination to themselves.

The typical procedure, for wet products, is FLUSH – STRIP – FLUSH. Flush off as much as you can, then remove outside clothes and flush again. For dry products such as powders, the procedure may need to be a dry decontamination followed by a wet decontamination. Response personnel need to consider the physical state and nature of the product and do what is best for the injured person.

By the time the injured person is decontaminated, you should have EMS assistance. In emergency decon, time is critical. You need to get the injured person to the EMS unit for treatment and transport to definitive care. And remember that the crew members who have done the emergency decontamination are now contaminated, and must decontaminate themselves.



## Undergoing Technical Decontamination (Performance Checklist A-45)

The following general tasks and/or steps should be followed when undergoing technical decontamination. Tasks/steps may vary by jurisdiction; be sure to follow your department's standard operating procedures/guidelines (SOPs/SOGs).

1. Tool drop - leave your tools at the tool drop stations.
2. Rinse thoroughly at the gross (primary) wash station.
3. Remove PPE while keeping respiratory protection in place.
4. Rinse at the secondary wash station and remove respiratory protection.
5. Proceed to medical evaluation station.
6. Proceed to the rest and rehab station.





## Module 4: Implement the Planned Response

### Lesson 4.1 - Scene Control and Responder Roles

#### Lesson Objectives<sup>1</sup>



#### NFPA® 472, 4.4.1

Given examples of hazmat/WMD incidents, the emergency response plan, the standard operating procedures, and the current edition of the ERG, identify the actions to be taken to protect yourself and others and to control access to the scene.

- (1) Identify the location of both the emergency response plan and/or standard operating procedures.
- (2) Identify the role of the awareness level personnel during hazmat/WMD incidents.
- (3) Identify the following basic precautions to be taken to protect themselves and others in hazmat/WMD incidents.
  - (a) Identify the precautions necessary when providing emergency medical care to victims of hazmat/WMD incidents.
  - (b) Identify typical ignition sources found at the scene of hazmat/WMD incidents.
  - (c) Identify the ways hazmats/WMDs are harmful to people, the environment and property.
  - (d) Identify the general routes of entry for human exposure to hazmats/WMDs agents.
- (4) Given examples of hazmats/WMDs agents and the identity of each (name, UN/NA identification number, or type placard), identify the following:
  - (a) Emergency action (fire, spill or leak and first aid)
  - (b) Personal protective equipment necessary
  - (c) Initial isolation and protective action distances
- (5) Given the name of a hazmat, identify the recommended PPE from the following list:
  - (a) Street clothing and work uniforms
  - (b) Structural fire-fighting protective clothing
  - (c) Positive pressure self-contained breathing apparatus
  - (d) Chemical-protective clothing and equipment

<sup>1</sup> NFPA 472® Standard for Competence of Responders to Hazardous Materials/Weapons of Mass Destruction, 2013 Edition.





- (6) Identify the definitions for each of the following protective actions:
  - (a) Isolation of the hazard area and denial of entry
  - (b) Evacuation
  - (c) Shelter-in-place
- (7) Identify the size and shape of recommended initial isolation and protective action zones.
- (8) Describe the difference between small and large spills as found in the Table of Initial Isolation and Protective Action Distances in the DOT Emergency Response Guidebook.
- (9) Identify the circumstances under which the following distances are used at a hazmat/WMD incident:
  - (a) Table of Initial Isolation and Protective Action Distances
  - (b) Isolation distances in the numbered guides
- (10) Describe the difference between the isolation distances on the orange-bordered guidebook pages and the protective action distances on the green-bordered ERG pages.
- (11) Identify the techniques used to isolate the hazard area and deny entry to unauthorized persons at hazmat/WMD incidents.
- (12) Identify at least four specific actions necessary when an incident is suspected to involve criminal or terrorist activity.

**NFPA® 472, 4.4.2**

Given scenarios involving hazmat/WMD incidents, identify the initial notifications to be made and how to make them, consistent with the AHJ.

**NFPA® 472, 5.4.1**

Given scenarios involving hazmat/WMD incidents, explain how to establish and maintain scene control, including control zones and emergency decontamination and communications between responders and to the public.

- (1) Identify the procedures for establishing scene control through control zones.
- (2) Identify the criteria for determining the locations of the control zones at hazmat/WMD incidents.
- (3) Identify the basic techniques for the following protective actions at hazmat/WMD incidents:
  - (a) Evacuation
  - (b) Shelter-in-place



- (5) Identify the items to be considered in a safety briefing prior to allowing personnel to work at the following:
  - (a) Hazmat/WMD incidents
  - (b) Hazmat/WMD incidents involving criminal activities
- (6) Identify the procedures for ensuring coordinated communication between responders and to the public.

**NFPA® 472, 5.4.3**

Given scenarios involving hazmat/WMD incidents, implement the incident command system as required by the AHJ.

- (1) Identify the role of the operations level responder during hazmat/WMD incidents as specified in the emergency response plan and/or standard operating procedures.
- (2) Identify the levels of hazmat/WMD incidents as defined in the emergency response plan.
- (3) Identify the purpose, need, benefits and elements of the incident command system for hazmat/WMD incidents.
- (4) Identify the duties and responsibilities of the following functions within the incident management system:
  - (a) Incident safety officer
  - (b) Hazardous materials branch or group
- (5) Identify the considerations for determining the location of the incident command post for a hazmat/WMD incident.
- (6) Identify the procedures for requesting additional resources at a hazmat/WMD incident.
- (7) Describe the role and response objectives of other agencies that respond to hazmat/WMD incidents.



## Implement the Planned Response

Recall that the implementation stage includes:

- Establishing and enforce scene control procedures.
- Establishing a means of evidence preservation, if a WMD incident is suspected.
- Establishing an emergency or technical decontamination area.
- Performing protective actions.
  - Rescue/recovery
  - Evacuation
  - Shelter-in-place
- Performing control options.
  - Extinguishment
  - Vapor suppression
  - Vapor dispersion
  - Absorption/adsorption
  - Dilution
  - Remote valve shut-off
  - Diking, damming, diversion or retention areas
- Performing decontamination.
- Removing PPE properly and take appropriate measures to prevent secondary contamination.

During implementation, the goal is to observe operations and outcomes in order to evaluate the effectiveness of action options.

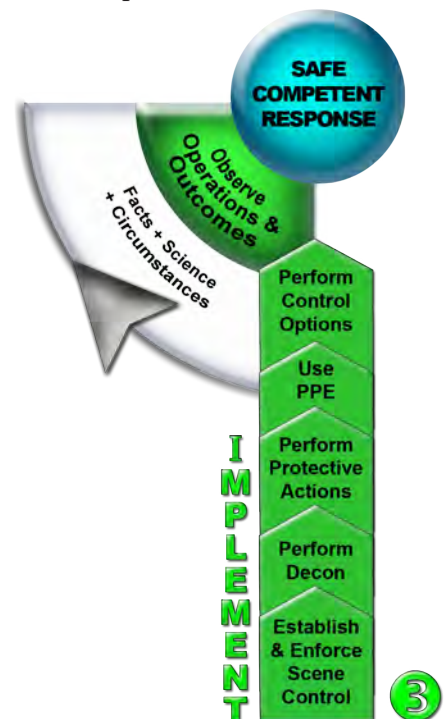



## Establish and Enforce Scene Control Procedures

The first unit responding to an emergency restricts public access by establishing boundaries to assure control of the site, avoid spread of contaminants, and enable safe movement of people and equipment around the hazard site.

### Hot Zone/Exclusion Zone

The hot zone is the area in which the hazmats are actually located, where contamination does or could occur. The goal is to isolate the hazard at its origin and keep the public away from it. This zone is restricted to essential personnel using appropriate protective clothing and equipment—ideally, a hazmat unit. Access to this area is tightly controlled at a single entry point, and limited to an assigned entry team.

Time within the hot zone must be minimized through careful planning and monitoring. The entry team must have communication devices and alternate plans for communication if radios do not function. There must be an emergency recall system in case it becomes necessary to rapidly evacuate the area.

### Warm Zone/Contamination Reduction Corridor

The warm zone is a transition area between the hot zone and the cold zone (clean area). Decontamination takes place in this warm zone, which requires personnel to use protective equipment appropriate to the level of hazard present. For incidents involving hazmats, chemical protective clothing is needed to operate in the decon corridor. The line that separates the hot zone from the warm zone is the hot line, which may be marked with barrier tape, safety cones or other highly visible devices.

### Cold Zone/Support Zone

The cold zone is the area farthest from potential contamination. The public is also excluded from this area to allow the fire department and other emergency response agencies space to function. The general public is limited to an outer perimeter established beyond the cold zone. The command post, entry team, treatment area for decontaminated patients, rehabilitation area for emergency response personnel and all other emergency response personnel work in the cold zone.



## Incident Command Post (ICP)

Upon arriving at an incident, an incident command post (ICP) must be established to coordinate the response. The ICP is the location where the incident commander operates during response operations. There is only one ICP for each incident or event, but it may change locations during the event if new evidence or changes to the response dictate a move.

Every incident or event must have some form of an incident command post. The ICP may be located in a vehicle, trailer, tent or within a building. The ICP will be positioned outside of the present and potential hazard zone to prevent potential contamination, but close enough to the incident to maintain command.

The location of this post must take into account factors such as:

- Type of hazard
- Weather conditions
- Access to the response scene







You respond to a spill of 3,000 gallons of sulfuric acid fuming from a rail car of a train that has just left the rail yard at 1300 hours on a weekday. Wind is blowing from the east at 5 mph. The terrain is flat or slightly sloping toward the water. Where would you establish each zone?

*Work with your team to establish demarcation lines for each zone on your copy of the map. Then place each of the following groups in an appropriate zone. Note that some responders may legitimately work in more than one zone, depending on the incident.*

**Potential Responders and Other Groups on the Scene**  
 (local protocol may vary)

- |                    |                    |                    |
|--------------------|--------------------|--------------------|
| 1. Command         | 5. EMS             | 9. Civilians       |
| 2. Fire Units      | 6. Entry Team      | 10. Media          |
| 3. HazMat Units    | 7. Backup Team     | 11. Communications |
| 4. Decontamination | 8. Law Enforcement | 12. Research       |

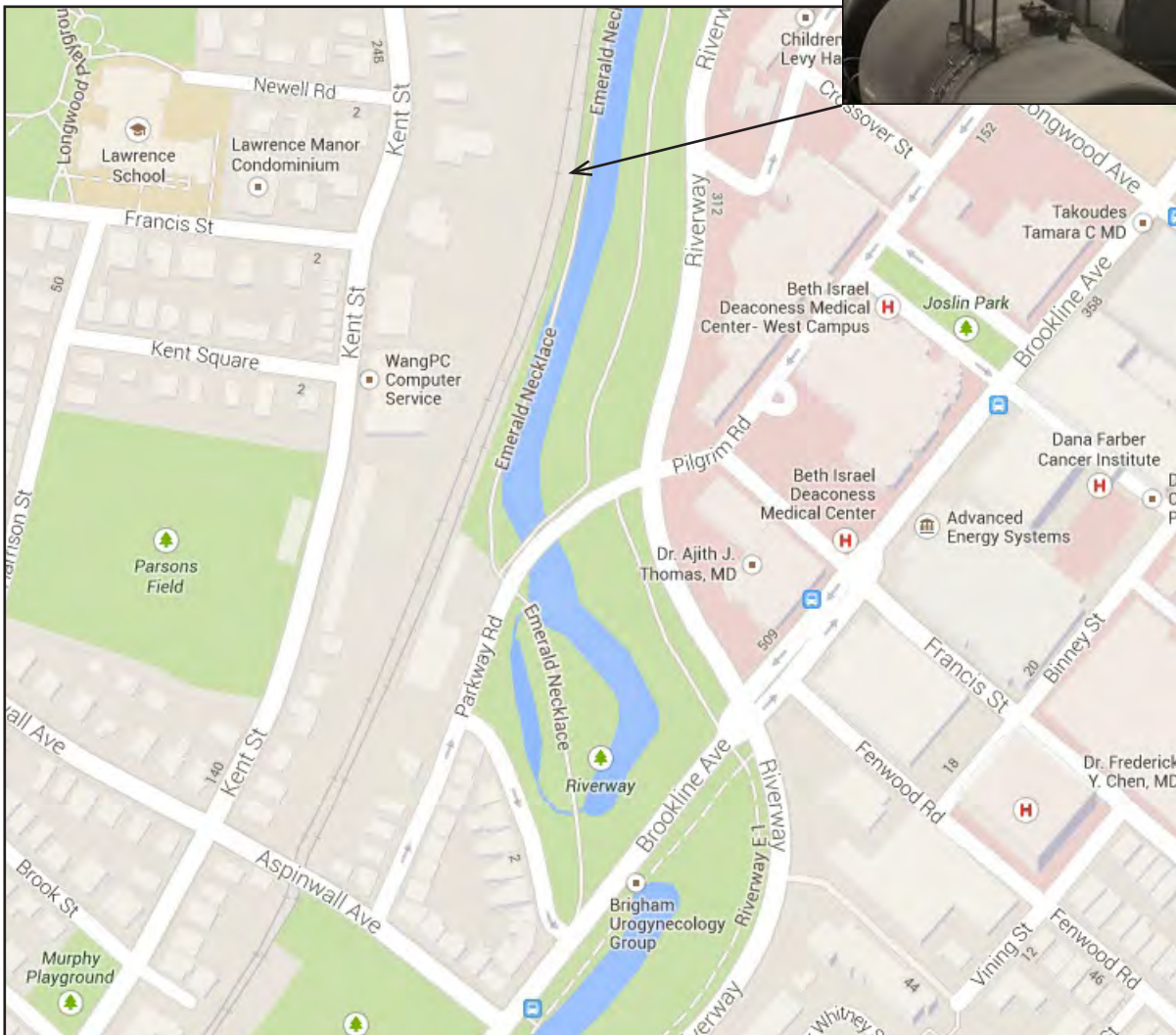





## Protective Actions

Protective actions are taken to ensure the safety of responders, the public, property and/or the environment.

### Protecting Responders

Protecting yourself and other responders should be your first priority. Protective actions that should be taken at hazardous materials/WMD incidents to ensure responder safety include:

- Staying uphill, upstream and upwind of the hazardous materials involved
- Implementing the incident command system (ICS) i.e., incident commander, safety officer, using a buddy system, backup team
- Having a safety briefing prior to implementing the planned response
- Correctly wearing the appropriate PPE
- Using time, distance and shielding
- Performing decontamination
- Maintaining personnel accountability
- Documenting and tracking personnel assignments
- Implementing, monitoring and adjusting isolation areas and control zones
- Evacuating, if necessary

### Protecting the Public

Protective actions that should be taken at hazardous materials/WMD incidents to ensure public safety include:

- Performing rescues
- Decontaminating victims
- Performing triage and treatment
- Transporting victims
- Evacuating the areas impacted
- Sheltering-in-place
- Combining evacuation with sheltering-in-place



## Evacuation

Evacuation is the process of removing people and animals, including fixed facility personnel and the public, to a safer location. Evacuation requires time to warn the public, and for the public to prepare for evacuation and to leave the area. The evacuation route should be uphill and upwind.

Evacuation should begin with those persons in the greatest danger. Evacuees should be provided with direction to a designated safe refuge area.

Personnel will be required to direct evacuees and maintain control of traffic. Responders may need to don PPE as they assist in the evacuation.

## Shelter-in-Place

Shelter-in-place, in-place protection and protection-in-place are all terms used to describe the process of directing the people to move indoors and remain inside until the danger has passed. As noted earlier, sheltering-in-place is appropriate if:

- The material is so toxic that the exposure, which may occur during the evacuation process, should not be risked.
- The release is expected to be short-term.
- Vulnerable populations, such as the elderly and the sick, could sustain greater injury during evacuation than by staying in place and taking appropriate protective actions.
- Vulnerable populations can be safely sheltered-in-place.



## Making the Choice

Evacuation is clearly safer with respect to the hazards, but has certain limitations and may pose new problems. Evacuation takes time and may not be possible if large numbers of persons or a large volume of vapor is present. In some cases, evacuation through a toxic atmosphere may actually cause more harm than sheltering-in-place. Large-scale evacuation will require a coordinated effort by many agencies.

Evacuation is best considered when:

- There is an immediate danger of fire or explosion.
- The potential for a discharge is great, it has not taken place, and there is time to relocate people.
- The discharge has taken place, but people are sufficiently protected to permit time for evacuation.
- People not yet in the path of a release will be threatened by changing conditions.

The decision to shelter-in-place is appropriate when the hazmats will not affect the structure and its occupants, or the hazard will pass a structure with little infiltration.

Sheltering-in-place is the preferred alternative when:

- Pre-planning has identified options for problem areas such as hospitals, jails, nursing homes and public assemblies.
- Evacuation cannot be properly managed with the manpower, resources and facilities presently available.
- The hazmats display the following characteristics:
  - Low to moderate toxicity
  - Totally released and dissipating
  - Small quantity solid or liquid leak
  - A migrating vapor of low toxicity and quantity, and people are safer indoors than outside
  - Release can be rapidly controlled at the source



## Factors to Consider Before Implementing Protective Actions

### The Materials Involved

Prior to implementing protection actions, consider the hazardous materials/WMDs involved:

- Hazards specific to the material or agent (i.e., the chemical and physical properties)
- Quantity of product or agent
- Rate of release and dispersion patterns
- The type of breach which caused the release
- The ability of available responders to implement the planned response (i.e., appropriate training and resources)

### The Environment

Prior to implementing protective actions, consider the following environmental factors:

- Wind direction and speed
- Ambient temperature
- Humidity levels
- Precipitation
- Topography

### The Public

Factors to consider related to the public include:

- The population density
- How close they are to the problem area
- The ability to communicate with the public, transportation and special needs (e.g., disabled individuals, elementary school children and pets)



### **Variables to Consider When Implementing an Incident Response**

#### PPE Usage

- ▶ Will the protection provided by SFPC/SCBA be sufficient?
- ▶ If not, is chemical protective equipment available?

#### Decontamination

- ▶ Can decontamination be effective? What resources are available/necessary?

#### Rescue/Recovery

- ▶ Is a rescue attempt appropriate?

#### Defensive Response Options

- ▶ Absorption, adsorption, damming, diking...

#### Spill Control Techniques

- ▶ Are resources available? Is spill control appropriate?

#### Requesting Additional Resources

- ▶ Have needed resources been identified?
- ▶ Are they available in a timely fashion?

#### Fire Control

- ▶ Can control efforts be successful?

### **Situations Requiring Withdrawal**

This training will help responders think quickly and respond accurately. Although there are many things to consider, time is of the essence. Given application of the course material, and experience on the job, seasoned responders try to consider all of these variables simultaneously (as if one set of conditions). They should reassess the situation throughout the response phase.

What circumstances would indicate the need to withdraw from a hazardous materials/WMD incident?

---



---



---



---



---



---



---



---



## Incident Management System

Effective scene management depends on a well-defined structure that is outlined in standard operating procedures, routinely practiced, and used at all incidents. An operation without an incident management system leads to poor use of resources and endangers the health and safety of response personnel.

In situations involving hazmats, incident management systems are not only useful, they are required by regulations established by the Occupational Safety and Health Administration (OSHA) and the Environmental Protection Agency (EPA). The regulations that specify the use of an incident management system are 29 CFR 1910.120 and 40 CFR 311, respectively. All fire fighters not covered by federal OSHA are covered by EPA regulations.

An incident command system places one person in charge of an incident, and guides deployment of personnel and equipment. It organizes personnel and tasks so that the person in charge is not overwhelmed. It eases communication by identifying reporting relationships and establishing a chain-of-command among personnel.

This type of systems approach applies to small incidents involving one or two companies, as well as large incidents involving agencies outside the fire department and crossing jurisdictional lines.

## Roles and Responsibilities

### Incident Commander

The incident commander is the individual responsible for all incident activities, including the development of strategies and tactics and the ordering and the release of resources.<sup>1</sup>

### Awareness Level Personnel

Awareness level personnel are those persons who, in the course of their normal duties, could encounter an emergency involving hazardous materials/WMD, and who are expected to recognize the presence of the hazardous materials/WMD, protect themselves, call for trained personnel and secure the area.

### Operations Level Responders

Operations level responders are those persons who respond to hazardous materials/WMD incidents for the purpose of protecting nearby persons, the environment or property from the effects of the release.

<sup>1</sup> NFPA® 472, 3.3.37





## Operations Level Responders Assigned Mission-Specific Responsibilities

Operations level responders may be assigned mission-specific responsibilities at hazardous materials/WMD incidents by the AHJ, beyond the core competencies at the operations level. Operations level responders may be specially trained and assigned to the following mission-specific responsibilities.

- Personal Protective Equipment (included in this course)
- Mass Decontamination
- Technical Decontamination
- Evidence Preservation and Sampling
- Product Control (included in this course)
- Air Monitoring and Sampling
- Victim Rescue
- Illicit Laboratory Incidents
- Improvise Explosive Devices, Dispersal Devices and Explosives Laboratories



## Support Staff

The command staff assists the incident commander. Since these are staff functions, their purpose is to support incident operations. None of these positions is directly involved in rescue, fire suppression or hazard control, but they are essential to successful operations.

### Safety Officer

The safety officer position should be implemented at every hazmat incident. Though the incident commander has overall responsibility for the safety and health of fire department members at the scene, an incident safety officer is appointed to help manage this task.

The incident safety officer assesses hazardous and unsafe situations at emergency incidents. In order to function effectively, this individual must have authority to prevent or stop unsafe acts that present an immediate danger to life or health.

### Liaison Officer

Numerous government agencies and private firms may become involved in hazmat incidents. The task of coordinating responding agencies may become too great for the incident commander, in which case a liaison officer may be appointed to assist in this function. The liaison officer helps to keep resources at a manageable distance from the command post while coordinating efforts.

### Public Information Officer

A public information officer (PIO) may be appointed if the incident commander requires assistance in providing information to the public and the news media. There may be a great demand for information regarding an incident, or the news media may be particularly helpful in supplying evacuation information to the public. Like other staff positions, the PIO must be trained and experienced in the role before an incident occurs.



Page left blank intentionally.



## Module 5 - Evaluate the Progress

### Lesson 5.1 - Terminate the Incident

#### Lesson Objectives<sup>1</sup>



##### NFPA® 472, 5.5.1

Given scenarios involving hazmat/WMD incidents, including the incident action plan, determine the effectiveness of the actions taken in accomplishing the response objectives.

- (1) Identify the considerations for evaluating whether actions taken were effective in accomplishing the objectives.
- (2) Describe the circumstances under which it would be prudent to withdraw from a hazmat/WMD incident.

##### NFPA® 472, 5.5.2

Given scenarios involving hazmat/WMD incidents, including the incident action plan, report the status of the planned response through the normal chain of command.

- (1) Identify the procedures for reporting the status of the planned response through the normal chain of command.
- (2) Identify the methods for immediate notification of the incident commander and other response personnel about critical emergency conditions at the incident.

##### NFPA® 472, 6.2.5.1

Given a scenario involving a hazmat/WMD incident, document use of the PPE by completing the documentation requirements of the emergency response plan or standard operating procedures regarding PPE.

#### Evaluating the Progress

Consider the following when evaluating the progress.

- ▶ Is the problem getting worse?
  - ▷ Has the breach become a release?
  - ▷ Is the rate of release increasing?
  - ▷ Is the fire bigger?
  - ▷ Is the material effecting additional exposures?
- ▶ Is the problem getting better?
  - ▷ Has the release stopped?
  - ▷ Is the released product contained?
  - ▷ Have the vapors dispersed?
- ▶ Are the weather conditions changing?
  - ▷ Is it getting windier?
  - ▷ Has the wind changed direction?
  - ▷ Is it raining or snowing?

<sup>1</sup> NFPA 472® Standard for Competence of Responders to Hazardous Materials/Weapons of Mass Destruction, 2013 Edition.



Page left blank intentionally.



## Evaluating the Progress

### Evaluate Response Status

Make decisions based on new information. As you gather new information, you should utilize the APIE process to help you make decisions. Throughout the incident, members must determine the extent to which response objectives are being met. The following questions should be considered:

- Does the strategy ensure personnel safety? Is the span of control manageable?
- Are personnel being tracked during the incident?
- Are crews adequately supervised?
- Are strategic priorities being met?
- If not, changes should be planned and initiated.

### Communicate the Status of the Incident

Plans and strategies can change drastically—and frequently—depending on how a given incident evolves. All involved units and support personnel should be continually apprised of response status until the incident can be formally terminated. Keeping lines of communication open and disseminating accurate information are difficult tasks to accomplish during the process of actually mitigating an emergency, but are needed for coordinated, safe and efficient incident resolutions.

Termination of a hazmat incident may include transfer of command. It will also involve record keeping, debriefing and post-incident analyses. Records to be collected include logs from all leaders, including the decontamination officer's notes, the incident safety officer's report or log, the operations chief and hazmat branch or group officer reports, and documents generated or collected by the incident commander (e.g., SDSs). Ensure that exposure and injury reports for all members are completed and filed according to the department's standard operating procedures and guidelines.

If possible, responders as a group should look back on how things went. This debriefing should occur as soon as possible after the incident has been stabilized. Health effects and concerns should be addressed, problems resolved and participants thanked for a job well done.

All aspects of the incident should be reviewed again with the benefit of hindsight, after some time has passed. All procedures and responses should be considered and critiqued for the sake of improvement. Standard operating procedures may need to be developed or revised, or more training may need to be provided.

Additional information on terminating the incident is provided on page 350.







## Critical Incident Stress Debriefing

The work of first responders often involves high levels of psychological stress. First responders and their families may be particularly concerned about health risks from exposures. A series of low level exposures (or potential exposures) may be as troubling as a single high level exposure. Unless these concerns are addressed, emergency responders may be fearful of hazmat response, or may experience other symptoms of stress.

Concerns about exposures should be addressed during the debriefing that immediately follows termination of the emergency phase of the incident. Included in the review of the incident should be a discussion of the hazmats involved, any exposures that occurred, the health effects of exposures and recommended follow-up medical care. In some cases, it may be necessary to devote time to a critical incident stress debriefing to help responders deal with traumatic events such as incidents in which:

- Response personnel were exposed to hazmats with unknown effects
- Chemicals involved are linked with long-term health effects, such as cancer
- Death of a civilian or first responder occurred



## Incident Documentation

Documentation of fire department response to a hazardous materials emergency is useful for several reasons. Documentation:

- Can be used to implement measures to prevent similar releases in the future
- Is necessary if cost recovery, legal action or public inquiry occurs
- Helps identify lessons learned

Documentation should begin as the fire department begins its role in the response, and should conclude with the collection and organization of reports. All information should be collected as soon as possible after an incident in order to obtain the most accurate and objective record of incident activities.

In addition to your records and incident command worksheets, documentation should include:

- Reports concerning the cause of the incident (if known)
- Disposition of wastes
- Narration describing any aspects not addressed in standard department reports
- A record of the role of various groups and agencies assisting at the emergency, including the names of the individuals representing or supervising these groups

The following items can be included to document fire department activities at hazmat incidents:

- Dispatch, EMS and standard incident reports
- Written personal accounts of those individuals in key positions during the response, especially regarding operations
- Audio and video tapes, including a recording of fire department radio communications
- An itemized list of consumed materials and damaged or destroyed equipment
- Copies of shipping papers or manufacturers' safety data sheets (SDSs), where applicable
- Hazmat team worksheets recording chemical information and recommendations of technical advisors
- Results of laboratory or field analysis
- Photographs labeled with date, time, incident location, photograph orientation (e.g., north, south), description of photo content and name of photographer
- Chain of custody forms to document the collection and handling of samples or evidence



## Terminating the Incident

### Key Point

Standard Operating Procedures/ Guidelines (SOPs/SOGs) that define the responsibilities and limitations of the fire department during termination must be established prior to any hazmat response. In particular, SOPs should address the actions the incident commander should take if an investigation is to take place, as in the case of illegal dumping. Your local environmental protection department can assist in establishing these procedures. The command post is not the place to set such policies.

Termination is the phase in which fire department activities are concluded, and responsibility for cleanup of the site is passed on to the federal, state or local agency having jurisdiction (AHJ). It may be difficult for you to determine the point at which fire department personnel and apparatus should be withdrawn from the scene. The transition from the containment/control phase of the incident to the termination phase may be blurred. For example, the fire department may be needed during cleanup to provide standby hose lines in case of flare-up.

### The Fire Department's Role in Cleanup

One important issue that must be resolved in advance is the fire department's role in cleanup procedures. Departments should limit their responsibilities to control of the emergency situation. Emergency response and hazmat cleanup are considered two different types of operations, with different program design requirements and employee qualifications.

Some departments, however, may offer support to cleanup contractors. For example, fire departments may stand by with hose lines during cleanup procedures at incidents that could revert to emergencies. If an incident does revert to an emergency situation, the fire department resumes command, and any work by cleanup workers is performed under the supervision of the incident commander.

It is the responsibility of the local jurisdiction to ensure that the cleanup contractors are qualified for the specified work that is required. This responsibility typically falls to state or local environmental protection agencies or health departments. It is usually the responsibility of the person or organization responsible for the release of hazmats to engage and pay for services.

Through pre-incident planning, you can develop a list of qualified contractors, their 24-hour contacts and their special skills.



## Implementing Termination Procedures

In a successful termination, the incident commander either concludes all activities at the site, or transfers oversight to the federal or local agency responsible for cleanup and environmental protection. The incident commander should consider the following questions when determining the appropriate point to conclude fire department activities at a site.

- Are the federal, or local agencies responsible for site control during cleanup organized? Have the officials in charge of these agencies been thoroughly briefed regarding current scene conditions, actions taken, hazmats present and the parties responsible for cleanup? Are these agencies prepared to assume control? Has transfer of responsibility been adequately documented?
- Has the release of the material been stopped and/or the reaction of the materials controlled? Is the overall emergency scene stable?
- Has the released hazmat been contained within a localized and manageable area?
- If hazmat cleanup is needed, is the area of contamination adequately secured to prevent civilians from coming in contact with the materials? Will the area be adequately supervised by someone working for or under the authority of the agencies charged with cleanup tasks? Are supervisory personnel familiar with the site and hazards involved? Are they prepared to handle the various site emergencies that might occur?
- Have the groups participating in the response completed a thorough scene assessment? Does the assessment identify all hazards associated with the materials released and their impact on people, environment and property?

Once you have determined that fire department operations are to be terminated, an organized plan of termination should be executed. Attention to the tasks listed on the pages, in this lesson, is necessary in order to prevent injury, unnecessary expense and liability.



## Post-Incident Analysis

During the process of terminating the emergency phase of an incident, you must inform those taking responsibility for cleanup of the:

- Overall status of the scene
- Hazards identified
- Emergency actions taken
- Responsible party
- Circumstances surrounding the release

In order to effectively transfer authority, a briefing should be conducted during the transition from emergency phase to cleanup phase. This briefing is separate and different from the debriefing conducted after the completion of the incident.

Post-incident analysis is a critical function of incident command. In a post-incident analysis, a review of the incident is conducted in order to identify the difficulties and successes encountered during emergency response. Once identified, these problems provide direction for planning efforts, fire fighter training, equipment purchase and the development of SOPs/SOGs. A thorough analysis will aid the incident commander in accurately appraising:

- Personnel and public safety during the incident
- Information and data management
- Media relations
- Interagency cooperation
- Overall functioning of the incident management system
- Effectiveness of control techniques
- Handling of site emergencies involving response personnel
- Evacuation, sheltering and public notification
- Role of technical advisors and on-site assistance

Emergency response plans for the involved community or site should be reviewed. The usefulness of the SOPs/SOGs implemented should be evaluated along with responders' adherence to them. Equipment that might allow more effective handling of future events should also be identified. Changes in departmental training programs should be made, as necessary. Rather than criticizing other agencies, it is best to allow the speaker for each responding agency to provide a self-assessment of the agency's role.



## Lesson 5.2 - Final Simulation

### Objectives

Given a hazmat/WMD scenario, you will apply the APIE response process and consider the facts, science and circumstances to:



- Analyze the problem.
- Plan the initial response.
- Describe how the plan would be implemented.
- Describe the considerations for evaluating the progress.

You will need to use the hazmat/WMD resources (ERG and NIOSH Pocket Guide) as well as the APIE Worksheet.



### Video

*The video simulates a hazardous materials incident. Use the space below for your notes.*

---

---

---

---

---

---

---

---

---

---

---

---

---

---

---

---

---

---

---

---

---

---

---

---





## APIE Worksheet

### Analyze the Problem

GOAL = Identify the Problem and Likely Behavior

Use the Chemical/Physical Properties Identification Form (next page) to help you collect the hazard information you'll need to predict behavior of hazmats and containers, and estimate outcomes. Use the space below for your notes.

### Type of Incident

- Fire       Chemical       Biological       Radiological/  
Nuclear       Explosive/  
Incendiary

Initiate ICS \_\_\_\_\_

\_\_\_\_\_

Survey the Incident \_\_\_\_\_

\_\_\_\_\_

Collect Hazard and Response Information \_\_\_\_\_

\_\_\_\_\_

Identify Container Type(s) and Stress \_\_\_\_\_

\_\_\_\_\_

Predict Behavior \_\_\_\_\_

\_\_\_\_\_

Estimate Outcomes \_\_\_\_\_

\_\_\_\_\_



## Chemical/Physical Properties Identification Form

Product/Chemical Names:	References Used:
-------------------------	------------------

### Chemical and Physical Properties

Physical State:	Form:	Vapor Pressure: mmHg/ATM
Flammable: Yes/No	LEL: %	UEL: %
Flash Point (FL.P): °F/C	Boiling Point (BP): °F/C	
Ignition (Auto) Temperature: °F/C		
Molecular Weight (MW):	Vapor Density (VD):	
Lighter/Heavier than Air:	Volatility:	
Specific Gravity (Sp. Gr.):	Solubility (SOL):	
Corrosive: pH	Reactive (with):	
Polymerization (potential): Yes/No		
Radioactive: Yes/No	Alpha:	Beta: Gamma:

### Health

Toxic: Yes/No	Routes of Exposure: Inhalation/Absorption/Ingestion/Injection	
Exposure Limits:	TLV-TWA:	TLV-STEL:
TLV-C:	PEL:	IDLH:
Comments:		



## Plan the Response

GOAL = Develop and Communicate the Incident Action Plan

Use the space below for your notes.

**Describe Response Objectives** \_\_\_\_\_

---

---

**Determine Personnel and/or Equipment Needs** \_\_\_\_\_

---

---

---

**Determine PPE Needs** \_\_\_\_\_

---

---

**Describe Decon Issues** \_\_\_\_\_

---

---

**Select Response Objectives** \_\_\_\_\_

---

---

---

---



## Implement the Plan

GOAL = Observe Operations and Outcomes

*Use the space below for your notes.*

**Establish and Enforce Scene Control** \_\_\_\_\_

---

---

**Perform Decon** \_\_\_\_\_

---

---

**Perform Protective Actions** \_\_\_\_\_

---

---

**Use PPE** \_\_\_\_\_

---

---

**Perform Control Options** \_\_\_\_\_

---

---



## Evaluate the Progress

GOAL = Assess Response Effectiveness

*Use the space below for your notes.*

**Evaluate Response Status** \_\_\_\_\_

---

---

---

**Communicate Response Status** \_\_\_\_\_

---

---

---

---



**FREDS HOT SHOT SERVICE**  
220 ALABAMA STREET  
HOUSTON, TEXAS 77001  
Phone 1-800-222-4030 Fax 1-800-231-8890

**•Non-Negotiable**  
**•BILL OF LADING**

MC 119444 FedID 0141049808

•No. 3347408 Page 1 OF 1

Date Received: 4/12/14	Dispatcii/Pro No: AL-34	Driver: Worthington	Truck No: FLATBED 344	Trailer No: STRAIGHT FLATBED TRUCK
---------------------------	----------------------------	------------------------	-----------------------------	---------------------------------------

**SHIPPER**

**CONSIGNEEE**

Name Service Chemical Company	Name International Precison Tool Corp
Street Address 100 ALABAMA ST	Street Address 64 San Felipe
City, State HOUSTON TX 77001	City, State, Zip Code Houston Texas 77001
Phone 800-809-6008	contact John B Good Phone 800 333 3453

**•PARTICULARS FURNISHED BY SHIPPER**

Units	HM	UN/NA Number, Proper Shipping Name, UN Hazard Class, Packing Group, Description,	Weight in Lbs.
1 Tote	x	UN 1090; Acetone; 3; PG II 500 gallons IBC with load immobilizing ratchet straps applied	3,275

<b>SHIPPER'S CERTIFICATIONS</b>	Placards Required: FLAMMABLE LIQUID	Emergency Telephone: 1-800-424-9300	ERG No. 127
Shipper declares that the packing/ loading of freight containers and/or transport vehicles containing hazardous materials has been carried out in accordance with the provisions of 49 C.F.R. 176.27(c). Signature: <i>Joe Jones</i>		This is to certify that the above-named materials are properly classified, described, packaged, marked and labeled, and are in proper condition for transportation according to the applicable national and international regulations. Signature: <i>Joe Jones</i>	

**LIABILITY FOR LOSS, DAMAGE, ETC, TO GOODS**

•Shippers attention is directed to Section 11 on the reverse side of this Bill of Lading. All goods shall have an agreed release valuation of \$0.10 per pound unless Shipper declares a higher value and Carrier accepts that valuation in the space below. For water carriage, see Section 5 on the reverse side of this Bill of Lading.  
Shipper's initials: *JJ* Higher value: \$ per pound \_\_\_\_\_ Carrier's acceptance: *(Signature)*

ORIGIN		DESTINATION	
time in:	time in:	time in:	time in:
time out:	time out:	time out:	time out:
date:	date:	date:	date:

•Received in good order, count and condition unless otherwise noted above.

<b>SHIPPER</b>	<b>FREDS HOT SHOT SERVICE</b>	<b>CONSIGNEE</b>
<i>Joe Jones</i> 4/12/14	<i>WJ</i> 4/12/14	_____
AUTHORIZED SIGNATURE DATE	AUTHORIZED SIGNATURE DATE	AUTHORIZED SIGNATURE DATE

•Subject to the terms and conditions on the reverse as well as Carrier's tariff, which may be reviewed at:





Page left blank intentionally.



Glendale  
PACKAGING

# MATERIAL SAFETY DATA SHEET

PRODUCT: ACETONE

Date of Issue: February 2013

Classified as hazardous

## 1. IDENTIFICATION OF THE MATERIAL AND THE SUPPLIER

**Product Name:** Acetone  
**Recommended Use:** Solvents used in the processing of resins, lacquers, waxes, adhesives, inks, paints, and plastics  
**Company:** Glendale Packaging Pty Ltd  
**Address:** Unit 1/75 Newton Road, Wetherill Park NSW 2164  
**Telephone Number:** (02) 9756 2315  
**Emergency Telephone:** (02) 9756 2315

## 2. HAZARDOUS IDENTIFICATION

**Hazardous Classification:** Hazardous substance according to the criteria of NOHSC.  
Dangerous goods classification according to the Australian Dangerous Goods Code.

**Risk Phase(s):** R11 – Highly flammable  
R36 – Irritating to eyes  
R65 – Harmful, may cause lung damage if swallowed  
R66 – Repeated exposure may cause skin dryness/cracking  
R 67 – Vapours may cause drowsiness and dizziness

**Safety Phase(s):** S9 – Keep container in a well ventilated place  
S 16 – Keep away from sources of ignition, no smoking  
S25 – Avoid contact with eyes  
S 26 – In case of contact with eyes, rinse immediately with plenty of water and seek medical advice  
S 29 – Do not empty drains  
S 33 – Take precautionary measures against static discharges

## 3. COMPOSITION/INFORMATION ON INGREDIENTS

Ingredients:	Name	CAS No	Proportion (w/w)
	Acetone	67-64-1	99.5%
	Water	7732-18-5	0.5%



---

#### 4. FIRST AID MEASURES

---

**Inhalation:**

Remove victim to fresh air. If not breathing, apply artificial respiration and seek urgent medical advice.

**Ingestion:**

If swallowed Do NOT induce vomiting. Rinse mouth thoroughly with water, give water to drink and seek urgent medical advice.

**Skin:**

Remove contaminated clothing and wash affected area on skin thoroughly with soap and water. Do not use solvent or thinners to wash skin

**Eye:**

Flush eyes with plenty of water for 15 minutes and seek urgent medical advice.

**First Aid Facilities:**

Eyewash and normal wash room facilities.

**Advice to Doctor:**

Treat symptomatically or consult a Poisons Information Centre (Phone 131126). Solvent aspirated into lungs may cause chemical pneumonitis.

---

#### 5. FIRE FIGHTING MEASURES

---

**Suitable Extinguishing Media:**

Use water, fog, CO<sub>2</sub>, dry chemical or alcohol foam.

**Hazards from Combustion Products:**

Carbon dioxide and carbon monoxide.

**Special Protection Equipment for Fire Fighters:**

Full protective clothing and self-contained breathing apparatus.

**Specific Methods:**

Use water spray to keep fire-exposed containers cool.

**Specific Hazards:**

This product is extremely flammable. Vapours are heavier than air and will "travel" to low-level areas eg. Sumps, drains, etc and flashback. Precautions should be taken to eliminate the build up of explosive mixtures.



**Hazchem Code:**

2[Y]E

**Unsuitable Extinguishing Media:**

The fire could easily be spread by the use of water in the area where the water could not be contained. Water may be ineffective in fighting the fire.

---

**6. ACCIDENTAL RELEASE MEASURES**

---

**Emergency Procedures:**

Wear appropriate personal protective equipment and clothing to minimise exposure. Extinguish or remove all sources of ignition and stop leak if safe to do so. Increase ventilation. Evacuate all unnecessary personnel. If possible contain the spill. Place inert absorbent material onto spillage. Use water spray to disperse vapours and dilute spill to a non-flammable mixture. Use clean non-sparking tools to collect the material and place into a suitable labeled container. Do not dilute material but contain. Dispose of waste according to federal Environment Protection Authority and state regulations. Do not allow to enter drains, sewers or waterways. If the spillage enters the waterways contact the Environmental Protection Authority, or your local Waste Management Authority.

---

**7. HANDLING AND STORAGE**

---

**Precautions for Safe Handling:**

Open containers cautiously as contents may be under pressure. Use only in well-ventilated area. Do NOT store or use in confined spaces. Do not enter these areas without respiratory protection or until the atmosphere has been checked. Keep tank covered and containers sealed when not in use. Build up of mists or vapours in the atmosphere must be prevented. Avoid inhalation of vapours and mists. Do not use near welding or other ignition sources and avoid sparks. Do not pressurise, cut, heat or weld containers as they may contain hazardous

residues. Do not smoke. Exposure without protection should be prevented. It is essential that all who come into contact with this material maintain high standards of personal hygiene, ie. washing hands prior to eating, drinking, smoking or using toilet facilities.

**Conditions for Safe Storage:**

Store in a cool, dry, well-ventilated area away from sources of ignition, oxidising agents, foodstuffs, and clothing out of direct sunlight. Keep containers closed when not in use and securely sealed and protected against physical damage. Inspect regularly for deficiencies such as damage or leaks. Always keep in containers made of the same material as the supply container. Have appropriate fire extinguishers available in and near the storage area. Take precautions against static electricity discharges. Use proper grounding procedures. Do not stack more than 3 pallets high. For information on the design of the storeroom, reference should be made to Australian Standard AS1940 – The Storage and Handling of Flammable





and Combustible Liquids. Reference should also be made to all State and Federal regulations.

---

## 8. EXPOSURE CONTROLS/PERSONAL PROTECTION

---

### National Exposure Standards:

Substance	STEL mg/m <sup>3</sup>	STEL ppm	TWA mg/m <sup>3</sup>	TWA ppm
Acetone	2375	1000	1185	500

### Engineering Controls:

Provide sufficient ventilation to keep airborne levels below the exposure limit. Where vapours or mists are generated, particularly in enclosed areas, and natural ventilation is inadequate, a flameproof exhaust ventilation system is required. Refer to AS1940 – The Storage and Handling of Hazardous Areas – Examples of Area Classification – General, for further information.

### Respiratory Protection:

If engineering controls are not effective in controlling airborne exposure then respiratory protective equipment should be used suitable for protecting against airborne contaminants. Final choice of appropriate breathing protection is dependant upon actual airborne concentrations and the type of breathing protection required will vary according to individual circumstances. Expert advice may be required to make this decision. Reference should be made to Australian Standards AS1715, Selection, Use and Maintenance of Respiratory Protective Devices and AS1716, Respiratory Protective Devices.

### Eye Protection:

Safety glasses with side shields, goggles or full-face shield as appropriate recommended. Final choice of appropriate eye/face protection will vary according to individual circumstances ie. Methods of handling or engineering controls and according to risk assessments undertaken. Eye protection should conform to AS1337 – Eye Protectors for Industrial Applications.

### Hand Protection:

Wear gloves of impervious material ie. chemical resistant gloves. Final choice of appropriate gloves will vary according to individual circumstances ie. Methods of handling or according to risk assessments undertaken. Reference should be made to AS2161.1: Occupational Protective Gloves – Selection, use and maintenance.



**Body Protection:**

Wear appropriate clothing including chemical resistant apron where clothing is likely to be contaminated. It is advisable that a local supplier of personal protective clothing is consulted regarding the choice of material.

---

**9. PHYSICAL AND CHEMICAL PROPERTIES**

---

<b>Appearance:</b>	Colourless, clear liquid with strong ketone odour
<b>Melting Point:</b>	-94.7°C
<b>Boiling Point:</b>	56°C
<b>Solubility in Water:</b>	Soluble
<b>Solubility in Organic Solvent:</b>	Soluble in common organic solvents
<b>Specific Gravity:</b>	0.791
<b>pH value:</b>	Not available
<b>Vapour Pressure:</b>	180mm Hg @ 20°C
<b>Vapour Density (Air = 1):</b>	2.0
<b>Volatile Component:</b>	100%
<b>Flash Point:</b>	-17°C
<b>Flammability:</b>	HIGHLY FLAMMABLE. This product should be stored and used in a well-ventilated area away from naked flames, sparks and other sources of ignition. Electrically link and ground metal containers for transfers of the product to prevent accumulation of static electricity. Keep the container tightly closed.
<b>Auto Ignition Temperature:</b>	465°C
<b>Flammable Limits – Lower:</b>	2.6%
<b>Flammable Limits – Upper:</b>	13%
<b>Molecular Weight:</b>	58.8

---

**10. STABILITY AND REACTIVITY**

---

**Chemical Stability:**

Stable under normal use conditions.

**Conditions to Avoid:**

Heat, direct sunlight, open flames or other sources of ignition and incompatibles.

**Incompatible Materials:**

Strong oxidising agents, strong acids.

**Hazardous Decomposition Products:**

Carbon dioxide and carbon monoxide.





**Glendale**  
PACKAGING

**Hazardous Reactions:**

Reacts violently with bromoform and chloroform in the presence of alkalis or in contact with alkaline surfaces. Decomposes violently in contact with nitric/sulphuric acid mixtures. Can react violently with oxidising agents.

**Hazardous Polymerization:**

Will not occur.

---

**11. TOXICOLOGICAL INFORMATION:**

---

**Toxicological Information:**

Oral LD50(rat): 9750 mg/kg

Inhalation LC50(rat): > 16,000 ppm/4hr

Dermal LD50(rabbit): > 20mL/kg (slight irritation)

Eye Irritation(rabbit): Moderate

**Inhalation:**

May cause irritation to the mucous membrane and upper airways, especially where vapours or mists are generated. Symptoms including sneezing, coughing, wheezing, shortness of breath, headache, dizziness, nausea and vomiting.

**Ingestion:**

Ingestion of this product may irritate the gastric tract causing nausea and vomiting.

**Skin:**

May cause redness, itching and irritation. Prolonged contact with skin may cause blistering and repeated contact may have a defatting effect causing dryness and cracking.

**Eye:**

Irritating to eyes. On eye contact this product will cause tearing, stinging, blurred vision and redness.

**Chronic Effects:**

Repeated or prolonged skin contact can cause severe irritation or dermatitis. Contact with this product over long periods can aggravate pre-existing medical conditions. Use of alcoholic beverages enhances toxic effects. Exposure may increase the toxic potential of chlorinated hydrocarbons, such as chloroform, trichloroethane.

---

**12. ECOLOGICAL INFORMATION**

---

**Ecotoxicity:**

This product has a potential to cause oxygen depletion in aqueous systems.

A low potential to affect aquatic organisms.



A low potential to affect secondary waste treatment microbial metabolism.  
A low potential to affect the growth of some plant seedlings.  
Overall this product is not expected to cause adverse environmental effects.

**Persistence/Degradability:**

This product has a high potential to degrade.

ThOD: 2.20g oxygen/g

COD: 1.12-2.07g oxygen/g

BOD-5: 0.31-1.85g oxygen/g

BOD-20: 1.78g oxygen/g

**Mobility:**

This product has a low potential to persist in the environment.

**Environment Protection:**

Do not allow product to enter drains, waterways or sewers.

**Acute Toxicity – Fish:**

96 hr LC50 (fathead minno): 7,280 – 8,120mg/L

**Acute Toxicity – Daphnia:**

24hr LC50 (Daphnia): >10,000mg/L

24hr EC50 (Daphnia): >10,000mg/L

---

**13. DISPOSAL CONSIDERATIONS**

---

**Waste Disposal:**

Dispose of waste according to federal, EPA and state regulations.

---

**14. TRANSPORT INFORMATION**

---

**Transport Information:**

This material is Class 3 – Flammable Liquid according to The Australian Code for the Transport of Dangerous Goods by Road and Rail. Class 3 – Flammable Liquids are incompatible in a placard load with any of the following:

- (Class 1) Explosives
- (Class 2.1) Flammable Gas
- (Class 2.3) Toxic Gas
- (Class 4.2) Spontaneously Combustible Substances
- (Class 5.1) Oxidising Agents
- (Class 5.2) Organic Peroxides
- (Class 6) Toxic Substances (where the flammable liquid is nitro methane)
- (Class 7) Radioactive Substance



**Glendale**  
PACKAGING

**U.N Number:** 1090  
**Proper Shipping Name:** Acetone  
**DG Class:** 3  
**Hazchem Code:** 2[Y]E  
**Packaging Method:** 3.8.3RT1  
**Packing Group:** II  
**EPG Number:** 3A1  
**IERG Number:** 14

---

#### 15. REGULATORY INFORMATION

---

**Poisons Schedule:** S5  
**National and or International Regulatory Information:** Classified as hazardous according to criteria of National Occupational Health and Safety Commission (NOHSC).  
**Packaging & Labeling:** As required by the ADG Code. As required by the National Code of Practice for the Labeling of Workplace Substances. As required by the Standard for the Uniform Scheduling of Drugs and Poisons.  
**AICS (Australia):** Listed.

---

#### 16. OTHER INFORMATION

---

References: (1) National Code of Practice for the preparation of Material Safety Data Sheets 2<sup>nd</sup> Edition [NOHSC:2011 (2003)], (2) Material Safety Data Sheet for Acetone issued by APS Specialty Chem dated August 2005, (3) Material Safety Data Sheet for Acetone issued by Packaging Inks (Aust) dated 2<sup>nd</sup> February 2009.

**Contact Point:** Director **Telephone:** (02) 9756 2315

DISCLAIMER: All information given in this data sheet and by the company's technical staff is compiled from the information currently available to the company. The company accepts no responsibility whatsoever for its accuracy, or for any results which may be obtained by customers. Any customer who relies upon any advice or information given in this data sheet by the company or by its technical staff does so entirely at its own risk, and the company will not be liable for any loss or damage thereby suffered notwithstanding any want of care on the part of the company or its staff in compiling or giving the advice or information.

---

**END OF MSDS**

---



## Cross-Reference to OSHA 1910.120 and NFPA® 472 Standard

### NFPA® 472 Competencies

This curriculum covers the awareness, operations, mission-specific: PPE and product control level competencies outlined in NFPA® 472: Standard for Competence of Responders to Hazardous Materials/Weapons of Mass Destruction. Free access to the standard is provided at [www.nfpa.org](http://www.nfpa.org).

### OSHA Requirements

This curriculum covers the OSHA 1910.120 training requirements for awareness and operations emergency response personnel. The table below provides those requirements.

Awareness Level Requirements	
1910.120(q)(6)(i)(A)	An understanding of what hazardous substances are, and the risks associated with them in an incident.
1910.120(q)(6)(i)(B)	An understanding of the potential outcomes associated with an emergency created when hazardous substances are present.
1910.120(q)(6)(i)(C)	The ability to recognize the presence of hazardous substances in an emergency.
1910.120(q)(6)(i)(D)	The ability to identify the hazardous substances, if possible.
1910.120(q)(6)(i)(E)	An understanding of the role of the first responder awareness individual in the employer's emergency response plan including site security and control and the U.S. Department of Transportation's Emergency Response Guidebook.
1910.120(q)(6)(i)(F)	The ability to realize the need for additional resources, and to make appropriate notifications to the communication center.
Operations Level Requirements	
1910.120(q)(6)(ii)(A)	Knowledge of the basic hazard and risk assessment techniques.
1910.120(q)(6)(ii)(B)	Know how to select and use proper personal protective equipment provided to the first responder operational level.
1910.120(q)(6)(ii)(C)	An understanding of basic hazardous materials terms.
1910.120(q)(6)(ii)(D)	Know how to perform basic control, containment and/or confinement operations within the capabilities of the resources and personal protective equipment available with their unit.
1910.120(q)(6)(ii)(E)	Know how to implement basic decontamination procedures.
1910.120(q)(6)(ii)(F)	An understanding of the relevant standard operating procedures and termination procedures.

The tables on the pages that follow, provide a cross-reference for both NFPA® competencies and OSHA training requirements.



<b>NFPA® Competency</b>	<b>OSHA 1910.120</b>	<b>Lesson Number and Title</b>
<b>Awareness Level Competencies</b>		
4.2.1	1910.120(q)(6)(i)(C)	2.1 - Recognizing Hazardous Materials
4.2.1(1)	1910.120(q)(6)(i)(A)	2.1 - Recognizing Hazardous Materials 2.6 - WMD Incidents
4.2.1(2)	1910.120(q)(6)(i)(A)	2.2 - Placards, Labels and Markings 2.3 - Emergency Response Guidebook
4.2.1(3)	1910.120(q)(6)(i)(A)	2.2 - Placards, Labels and Markings 2.3 - Emergency Response Guidebook
4.2.1(4)	1910.120(q)(6)(i)(A)	2.6 - WMD Incidents
4.2.1(5)	1910.120(q)(6)(i)(C)	2.1 - Recognizing Hazardous Materials
4.2.1(6)	1910.120(q)(6)(i)(C)	2.8 - Container Shapes and Sizes
4.2.1(7)	1910.120(q)(6)(i)(C) 1910.120(q)(6)(i)(D)	2.2 - Placards, Labels and Markings 2.6 - WMD Incidents
4.2.1(8)	1910.120(q)(6)(i)(C) 1910.120(q)(6)(i)(D)	2.2 - Placards, Labels and Markings
4.2.1(9)	1910.120(q)(6)(i)(C) 1910.120(q)(6)(i)(D)	2.2 - Placards, Labels and Markings
4.2.1(10)	1910.120(q)(6)(i)(A) 1910.120(q)(6)(i)(B)	2.7 - Shipping Papers and Facility Documents
4.2.1(11)	1910.120(q)(6)(i)(C)	2.10 - Using the APIE Model
4.2.1(12)	1910.120(q)(6)(i)(C)	2.10 - Using the APIE Model
4.2.1(13)	1910.120(q)(6)(i)(C)	2.6 - WMD Incidents
4.2.1(14)	1910.120(q)(6)(i)(A)	2.6 - WMD Incidents
4.2.1(15)	1910.120(q)(6)(i)(C)	2.6 - WMD Incidents
4.2.1(16)	1910.120(q)(6)(i)(C)	2.6 - WMD Incidents
4.2.1(17)	1910.120(q)(6)(i)(C)	2.6 - WMD Incidents
4.2.1(18)	1910.120(q)(6)(i)(C)	2.6 - WMD Incidents
4.2.1(19)	1910.120(q)(6)(i)(C)	2.6 - WMD Incidents
4.2.1(20)	1910.120(q)(6)(i)(C)	2.6 - WMD Incidents
4.2.2	1910.120(q)(6)(i)(D)	2.3 - Emergency Response Guidebook 2.6 - WMD Incidents
4.2.2(1)	1910.120(q)(6)(i)(D)	2.10 - Using the APIE Model
4.2.2(2)	1910.120(q)(6)(i)(D) 1910.120(q)(6)(i)(E)	2.2 - Placards, Labels and Markings 2.3 - Emergency Response Guidebook
4.2.2(3)	1910.120(q)(6)(i)(D) 1910.120(q)(6)(i)(E)	2.2 - Placards, Labels and Markings 2.3 - Emergency Response Guidebook
4.2.3	1910.120(q)(6)(i)(D) 1910.120(q)(6)(i)(E)	2.3 - Emergency Response Guidebook
4.2.3(1)	1910.120(q)(6)(i)(E)	2.3 - Emergency Response Guidebook
4.2.3(2)	1910.120(q)(6)(i)(E)	2.3 - Emergency Response Guidebook
4.4.1	1910.120(q)(6)(i)(E)	4.1 - Scene Control and Responder Roles
4.4.1(1)	1910.120(q)(6)(i)(F)	4.1 - Scene Control and Responder Roles





<b>NFPA® Competency</b>	<b>OSHA 1910.120</b>	<b>Lesson Number and Title</b>
4.4.1(2)	1910.120(q)(6)(i)(F)	4.1 - Scene Control and Responder Roles
4.4.1(3)	1910.120(q)(6)(i)(E)	2.5 - Health and Safety Threats 4.1 - Scene Control and Responder Roles
4.4.1(4)	1910.120(q)(6)(i)(E)	4.1 - Scene Control and Responder Roles
4.4.1(5)	1910.120(q)(6)(i)(E)	4.1 - Scene Control and Responder Roles
4.4.1(6)	1910.120(q)(6)(i)(E)	4.1 - Scene Control and Responder Roles
4.4.1(7)	1910.120(q)(6)(i)(E)	4.1 - Scene Control and Responder Roles
4.4.1(8)	1910.120(q)(6)(i)(E)	4.1 - Scene Control and Responder Roles
4.4.1(9)	1910.120(q)(6)(i)(E)	4.1 - Scene Control and Responder Roles
4.4.1(10)	1910.120(q)(6)(i)(E)	4.1 - Scene Control and Responder Roles
4.4.1(11)	1910.120(q)(6)(i)(E)	4.1 - Scene Control and Responder Roles
4.4.1(12)	1910.120(q)(6)(i)(E)	2.6 - WMD Incidents 4.1 - Scene Control and Responder Roles
4.4.2	1910.120(q)(6)(i)(F)	4.1 - Scene Control and Responder Roles
<b>Operations Level Competencies</b>		
5.2.1	1910.120(q)(6)(i)(C) 1910.120(q)(6)(i)(D)	2.8 - Container Shapes and Sizes 2.10 - Using the APIE Model
5.2.1.1	1910.120(q)(6)(i)(C) 1910.120(q)(6)(i)(D)	2.8 - Container Shapes and Sizes
5.2.1.1.1	1910.120(q)(6)(i)(C) 1910.120(q)(6)(i)(D)	2.8 - Container Shapes and Sizes
5.2.1.1.2	1910.120(q)(6)(i)(C) 1910.120(q)(6)(i)(D)	2.8 - Container Shapes and Sizes
5.2.1.1.3	1910.120(q)(6)(i)(C) 1910.120(q)(6)(i)(D)	2.8 - Container Shapes and Sizes
5.2.1.1.4	1910.120(q)(6)(i)(C) 1910.120(q)(6)(i)(D)	2.8 - Container Shapes and Sizes
5.2.1.1.5	1910.120(q)(6)(i)(C) 1910.120(q)(6)(i)(D)	2.8 - Container Shapes and Sizes
5.2.1.1.6	1910.120(q)(6)(i)(C) 1910.120(q)(6)(i)(D)	2.8 - Container Shapes and Sizes
5.2.1.1.7	1910.120(q)(6)(i)(C) 1910.120(q)(6)(i)(D)	2.8 - Container Shapes and Sizes
5.2.1.2	1910.120(q)(6)(i)(C)	2.8 - Container Shapes and Sizes
5.2.1.2.1	1910.120(q)(6)(i)(D)	2.8 - Container Shapes and Sizes
5.2.1.2.2	1910.120(q)(6)(i)(D)	2.2 - Placards, Labels and Markings
5.2.1.3	1910.120(q)(6)(i)(D)	2.2 - Placards, Labels and Markings 2.8 - Container Shapes and Sizes
5.2.1.3.1	1910.120(q)(6)(i)(D)	2.8 - Container Shapes and Sizes
5.2.1.3.2	1910.120(q)(6)(i)(D)	2.2 - Placards, Labels and Markings
5.2.1.3.3	1910.120(q)(6)(i)(D)	2.2 - Placards, Labels and Markings
5.2.1.4	1910.120(q)(6)(ii)(A)	2.10 - Using the APIE Model





<b>NFPA® Competency</b>	<b>OSHA 1910.120</b>	<b>Lesson Number and Title</b>
5.2.1.5	1910.120(q)(6)(ii)(A)	2.10 - Using the APIE Model
5.2.1.6	1910.120(q)(6)(ii)(A)	2.6 - WMD Incidents
5.2.2	1910.120(q)(6)(ii)(A)	2.7 - Shipping Papers and Facility Documents
5.2.2(1)	1910.120(q)(6)(ii)(A)	2.2 - Placards, Labels and Markings
5.2.2(2)	1910.120(q)(6)(ii)(A)	2.7 - Shipping Papers and Facility Documents
5.2.2(3)	1910.120(q)(6)(ii)(A)	2.7 - Shipping Papers and Facility Documents
5.2.2(4)	1910.120(q)(6)(ii)(A)	2.10 - Using the APIE Model
5.2.2(5)	1910.120(q)(6)(ii)(A)	2.10 - Using the APIE Model
5.2.2(6)	1910.120(q)(6)(ii)(A)	2.6 - WMD Incidents
5.2.2(7)	1910.120(q)(6)(ii)(A)	2.10 - Using the APIE Model
5.2.2(8)	1910.120(q)(6)(ii)(A)	2.4 - NIOSH Pocket Guide and Chemical/Physical Properties
5.2.3	1910.120(q)(6)(ii)(A) 1910.120(q)(6)(i)(B)	2.8 - Container Shapes and Sizes
5.2.3(1)	1910.120(q)(6)(ii)(C)	2.10 - Using the APIE Model
5.2.3(1)(a)	1910.120(q)(6)(ii)(C)	2.4 - NIOSH Pocket Guide and Chemical/Physical Properties
5.2.3(1)(b)	1910.120(q)(6)(ii)(C)	2.6 - WMD Incidents
5.2.3(2)	1910.120(q)(6)(ii)(A) 1910.120(q)(6)(i)(B)	2.5 - Health and Safety Threats
5.2.3(3)	1910.120(q)(6)(ii)(A) 1910.120(q)(6)(i)(B)	2.8 - Container Shapes and Sizes
5.2.3(4)	1910.120(q)(6)(ii)(A) 1910.120(q)(6)(i)(B)	2.8 - Container Shapes and Sizes
5.2.3(5)	1910.120(q)(6)(ii)(A) 1910.120(q)(6)(i)(B)	2.8 - Container Shapes and Sizes
5.2.3(6)	1910.120(q)(6)(ii)(A) 1910.120(q)(6)(i)(B)	2.8 - Container Shapes and Sizes
5.2.3(7)	1910.120(q)(6)(ii)(A) 1910.120(q)(6)(i)(B)	2.8 - Container Shapes and Sizes
5.2.3(8)	1910.120(q)(6)(i)(B) 1910.120(q)(6)(ii)(C)	2.4 - NIOSH Pocket Guide and Chemical/Physical Properties 2.5 - Health and Safety Threats
5.2.3(9)	1910.120(q)(6)(i)(B) 1910.120(q)(6)(ii)(C)	2.6 - WMD Incidents
5.2.4	1910.120(q)(6)(ii)(A) 1910.120(q)(6)(i)(B)	2.10 - Using the APIE Model
5.2.4(1)	1910.120(q)(6)(ii)(A) 1910.120(q)(6)(i)(E)	2.3 - Emergency Response Guidebook
5.2.4(2)	1910.120(q)(6)(ii)(A)	2.10 - Using the APIE Model
5.2.4(3)	1910.120(q)(6)(ii)(A)	2.10 - Using the APIE Model
5.2.4(4)	1910.120(q)(6)(ii)(A)	2.10 - Using the APIE Model
5.2.4(5)	1910.120(q)(6)(ii)(A)	2.4 - NIOSH Pocket Guide and Chemical/Physical Properties
5.3.1	1910.120(q)(6)(ii)(A)	3.1 - Response Objectives and Action Options



<b>NFPA® Competency</b>	<b>OSHA 1910.120</b>	<b>Lesson Number and Title</b>
5.3.1(1)	1910.120(q)(6)(ii)(A) 1910.120(q)(6)(i)(B)	3.1 - Response Objectives and Action Options
5.3.1(2)	1910.120(q)(6)(ii)(A) 1910.120(q)(6)(i)(B)	3.1 - Response Objectives and Action Options
5.3.1(3)	1910.120(q)(6)(ii)(A) 1910.120(q)(6)(i)(B)	3.1 - Response Objectives and Action Options
5.3.1(4)	1910.120(q)(6)(ii)(A) 1910.120(q)(6)(i)(B)	2.6 - WMD Incidents 3.1 - Response Objectives and Action Options
5.3.2	1910.120(q)(6)(ii)(A)	3.1 - Response Objectives and Action Options
5.3.2(1)	1910.120(q)(6)(ii)(A)	3.1 - Response Objectives and Action Options
5.3.2(2)	1910.120(q)(6)(ii)(A)	3.1 - Response Objectives and Action Options
5.3.3	1910.120(q)(6)(ii)(C)	3.2 - Personal Protective Equipment
5.3.3(1)	1910.120(q)(6)(ii)(C)	3.2 - Personal Protective Equipment
5.3.3(2)	1910.120(q)(6)(ii)(C)	3.2 - Personal Protective Equipment
5.3.4	1910.120(q)(6)(ii)(E)	3.3 - Decontamination
5.3.4(1)	1910.120(q)(6)(ii)(E)	2.5 - Health and Safety Threats 3.3 - Decontamination
5.3.4(2)	1910.120(q)(6)(ii)(E)	2.5 - Health and Safety Threats 3.3 - Decontamination
5.3.4(3)	1910.120(q)(6)(ii)(E)	2.5 - Health and Safety Threats 3.3 - Decontamination
5.3.4(4)	1910.120(q)(6)(ii)(E)	3.3 - Decontamination
5.3.4(5)	1910.120(q)(6)(ii)(E)	3.3 - Decontamination
5.4.1	1910.120(q)(6)(ii)(D)	4.1 - Scene Control and Responder Roles
5.4.1(1)	1910.120(q)(6)(ii)(D)	4.1 - Scene Control and Responder Roles
5.4.1(2)	1910.120(q)(6)(ii)(D)	4.1 - Scene Control and Responder Roles
5.4.1(3)	1910.120(q)(6)(ii)(D)	4.1 - Scene Control and Responder Roles
5.4.1(4)	1910.120(q)(6)(ii)(E)	3.3 - Decontamination
5.4.1(5)	1910.120(q)(6)(ii)(F)	4.1 - Scene Control and Responder Roles
5.4.1(6)	1910.120(q)(6)(ii)(F)	4.1 - Scene Control and Responder Roles
5.4.2	1910.120(q)(6)(ii)(D) 1910.120(q)(6)(ii)(F)	2.6 - WMD Incidents
5.4.3	1910.120(q)(6)(ii)(F)	4.1 - Scene Control and Responder Roles
5.4.3(1)	1910.120(q)(6)(ii)(F)	4.1 - Scene Control and Responder Roles
5.4.3(2)	1910.120(q)(6)(ii)(F)	4.1 - Scene Control and Responder Roles
5.4.3(3)	1910.120(q)(6)(ii)(F)	4.1 - Scene Control and Responder Roles
5.4.3(4)	1910.120(q)(6)(ii)(F)	4.1 - Scene Control and Responder Roles
5.4.3(5)	1910.120(q)(6)(ii)(F)	4.1 - Scene Control and Responder Roles
5.4.3(6)	1910.120(q)(6)(i)(F) 1910.120(q)(6)(ii)(F)	4.1 - Scene Control and Responder Roles



<b>NFPA® Competency</b>	<b>OSHA 1910.120</b>	<b>Lesson Number and Title</b>
5.4.3(7)	1910.120(q)(6)(i)(F) 1910.120(q)(6)(ii)(F)	4.1 - Scene Control and Responder Roles
5.4.4	1910.120(q)(6)(ii)(B)	3.2 - Personal Protective Equipment
5.4.4(1)	1910.120(q)(6)(ii)(B)	3.2 - Personal Protective Equipment
5.4.4(2)	1910.120(q)(6)(ii)(B)	3.2 - Personal Protective Equipment
5.4.4(3)	1910.120(q)(6)(ii)(B)	3.2 - Personal Protective Equipment
5.4.4(4)	1910.120(q)(6)(ii)(B)	3.2 - Personal Protective Equipment
5.4.4(5)	1910.120(q)(6)(ii)(B)	3.2 - Personal Protective Equipment
5.4.4(6)	1910.120(q)(6)(ii)(B)	3.2 - Personal Protective Equipment
5.4.4(7)	1910.120(q)(6)(ii)(B)	3.2 - Personal Protective Equipment
5.5.1	1910.120(q)(6)(ii)(F)	5.1 - Terminate the Incident
5.5.1(1)	1910.120(q)(6)(i)(F) 1910.120(q)(6)(ii)(F)	5.1 - Terminate the Incident
5.5.1(2)	1910.120(q)(6)(i)(F) 1910.120(q)(6)(ii)(F)	5.1 - Terminate the Incident
5.5.2	1910.120(q)(6)(i)(F) 1910.120(q)(6)(ii)(F)	5.1 - Terminate the Incident
5.5.2(1)	1910.120(q)(6)(i)(F) 1910.120(q)(6)(ii)(F)	5.1 - Terminate the Incident
5.5.2(2)	1910.120(q)(6)(i)(F) 1910.120(q)(6)(ii)(F)	5.1 - Terminate the Incident
<b>Mission-Specific: PPE Competencies</b>		
6.2.3.1	1910.120(q)(6)(ii)(B)	3.2 - Personal Protective Equipment
6.2.3.1(1)	1910.120(q)(6)(ii)(B)	3.2 - Personal Protective Equipment
6.2.3.1(2)	1910.120(q)(6)(ii)(B)	3.2 - Personal Protective Equipment
6.2.3.1(3)	1910.120(q)(6)(ii)(B)	3.2 - Personal Protective Equipment
6.2.4.1	1910.120(q)(6)(ii)(B)	3.2 - Personal Protective Equipment
6.2.4.1(1)	1910.120(q)(6)(ii)(B)	3.2 - Personal Protective Equipment
6.2.4.1(2)	1910.120(q)(6)(ii)(B)	3.2 - Personal Protective Equipment
6.2.4.1(3)	1910.120(q)(6)(ii)(B)	3.2 - Personal Protective Equipment
6.2.4.1(4)	1910.120(q)(6)(ii)(B)	3.2 - Personal Protective Equipment 3.3 - Decontamination
6.2.4.1(5)	1910.120(q)(6)(ii)(B)	3.2 - Personal Protective Equipment
6.2.5.1	1910.120(q)(6)(ii)(B) 1910.120(q)(6)(ii)(F)	5.1 - Terminate the Incident
<b>Mission-Specific: Product Control</b>		
6.6.3.1	1910.120(q)(6)(ii)(D)	3.1 - Response Objectives and Action Options
6.6.3.1(1)	1910.120(q)(6)(ii)(D)	3.1 - Response Objectives and Action Options
6.6.3.1(2)	1910.120(q)(6)(ii)(D)	3.1 - Response Objectives and Action Options
6.6.3.2	1910.120(q)(6)(ii)(B)	3.2 - Personal Protective Equipment
6.6.4.1	1910.120(q)(6)(ii)(D)	3.1 - Response Objectives and Action Options



<b>NFPA® Competency</b>	<b>OSHA 1910.120</b>	<b>Lesson Number and Title</b>
6.6.4.1(1)	1910.120(q)(6)(ii)(D)	3.1 - Response Objectives and Action Options
6.6.4.1(2)	1910.120(q)(6)(ii)(D)	3.1 - Response Objectives and Action Options
6.6.4.1(3)	1910.120(q)(6)(ii)(D)	3.1 - Response Objectives and Action Options
6.6.4.1(4)	1910.120(q)(6)(ii)(D)	3.1 - Response Objectives and Action Options
6.6.4.1(5)	1910.120(q)(6)(ii)(D)	3.1 - Response Objectives and Action Options
6.6.4.2	1910.120(q)(6)(ii)(E)	3.3 - Decontamination



## Glossary

The terms in this glossary have been consolidated from a variety of sources (e.g., the United States Department of Transportation, the United States National Incident Management System (NIMS), NFPA® standards). The source for each term is provided in brackets. The wording and formatting used by the sources have been preserved.

**Acute Exposure Guideline Level(s) (AEGLs).** Represent threshold exposure limits for the general public after a once-in-a-lifetime, or rare, exposure and are applicable to emergency exposure periods ranging from 10 minutes to 8 hours. Three levels AEGL-1, AEGL-2 and AEGL-3 are developed for each of five exposure periods (10 and 30 minutes, 1 hour, 4 hours, and 8 hours) and are distinguished by varying degrees of severity of toxic effects; see AEGL-1, AEGL-2 and AEGL-3.

**AEGL-1** is the airborne concentration (expressed as parts per million or milligrams per cubic meter [ppm or mg/m<sup>3</sup>]) of a substance above which it is predicted that the general population, including susceptible individuals, could experience notable discomfort, irritation, or certain asymptomatic, non-sensory effects. However, the effects are not disabling and are transient and reversible upon cessation of exposure.

**AEGL-2** is the airborne concentration (expressed as ppm or mg/m<sup>3</sup>) of a substance above which it is predicted that the general population, including susceptible individuals, could experience irreversible or other serious, long-lasting adverse health effects or an impaired ability to escape.

AEGL-3 is the airborne concentration (expressed as ppm or mg/m<sup>3</sup>) of a substance above which it is predicted that the general population, including susceptible individuals, could experience life-threatening health effects or death. [ERG 2012]

**Agency.** A division of government with a specific function offering a particular kind of assistance. In the Incident Command System, agencies are defined either as jurisdictional (having statutory responsibility for incident management) or as assisting or cooperating (providing resources or other assistance). Governmental organizations are most often in charge of an incident, though in certain circumstances private-sector organizations may be included. Additionally, nongovernmental organizations may be included to provide support. [NIMS 2008]

**Agent-Specific Competencies.** The knowledge, skills, and judgment needed by operations level responders who have completed the operations level competencies and who are designated by the authority having jurisdiction to respond to releases or potential releases of a specific group of CBRNE agents. [NFPA® 472, 3.4.1]

**Alcohol Resistant Foam.** A foam that is resistant to “polar” chemicals such as ketones and esters which may break down other types of foam. [ERG 2012]

**All-Hazards.** Describing an incident, natural or manmade, that warrants action to protect life, property, environment, and public health or safety, and to minimize disruptions of government, social, or economic activities. [NIMS 2008]

**Allied Professional.** That person who possesses the knowledge, skills, and technical competence to provide assistance in the selection, implementation, and evaluation of mission-specific tasks at a hazardous materials/weapons of mass destruction (WMD) incident. [NFPA® 472, 3.3.1]

**Analyze.** The process of identifying a hazardous materials/weapons of mass destruction (WMD) problem and determining likely behavior and harm within the training and capabilities of the emergency responder. [NFPA® 472, 3.3.2]

**Aerosol.** Any non-refillable receptacle containing a gas compressed, liquefied or dissolved under pressure, the sole purpose of which is to expel a nonpoisonous (other than a Division 6.1 Packing Group III material) liquid, paste, or powder and fitted with a self-closing release device allowing the contents to be ejected by the gas. [49 CFR, § 171.8]



**Asphyxiant gas.** A gas which dilutes or replaces oxygen normally in the atmosphere. [49 CFR, § 171.8]

**As Low As Reasonably Achievable (ALARA).** A principle of radiation protection philosophy that requires that exposures to ionizing radiation shall be kept as low as reasonably achievable, economic and social factors being taken into account. The protection from radiation exposure is ALARA when the expenditure of further resources would be unwarranted by the reduction in exposure that would be achieved. [National Council on Radiation Protection & Measurements, Commentary No. 19, Key Elements of Preparing Emergency Responders for Nuclear and Radiological Terrorism (NCRP)]

**Assignments.** Tasks given to resources to perform within a given operational period, based upon tactical objectives in the Incident Action Plan. [ICS Glossary]

**Authority Having Jurisdiction (AHJ).** An organization, office, or individual responsible for enforcing the requirements of a code or standard, or for approving equipment, materials, an installation, or a procedure. [NFPA® 472, 3.2.2]

**Available Resources.** Resources assigned to an incident, checked in, and available for a mission assignment, normally located in a Staging Area. [ICS Glossary]

**Awareness Level Personnel.** (29 CFR 1910.120: First Responder at the Awareness Level) Personnel who, in the course of their normal duties, could encounter an emergency involving hazardous materials/weapons of mass destruction (WMD) and who are expected to recognize the presence of the hazardous materials/weapons of mass destruction (WMD), protect themselves, call for trained personnel, and secure the scene. [NFPA® 472, 3.3.4]

**Bag.** A flexible packaging made of paper, plastic film, textiles, woven material or other similar materials. [49 CFR, § 171.8]

**Biological Agents.** Living organisms that cause disease, sickness and mortality in humans. Anthrax and Ebola are examples of biological agents. Refer to GUIDE 158. [ERG 2012]

**Biological Terrorism Agents.** Liquid or particulate agents that can consist of a biologically derived toxin or pathogen to inflict lethal or incapacitating casualties. [NFPA® 472, A.3.3.29]

**Blister Agents (Vesicants).** Substances that cause blistering of the skin. Exposure is through liquid or vapor contact with any exposed tissue (eyes, skin, lungs). Mustard (H), Distilled Mustard (HD), Nitrogen Mustard (HN) and Lewisite (L) are blister agents. Symptoms: Red eyes, skin irritation, burning of skin, blisters, upper respiratory damage, cough, hoarseness. [ERG 2012]

**Blood Agents.** Substances that injure a person by interfering with cell respiration (the exchange of oxygen and carbon dioxide between blood and tissues). Hydrogen cyanide (AC) and Cyanogen chloride (CK) are blood agents. Symptoms: Respiratory distress, headache, unresponsiveness, seizures, coma. [ERG 2012]

**Bottle.** An inner packaging having a neck of relatively smaller cross section than the body and an opening capable of holding a closure for retention of the contents. [49 CFR, § 171.8]

**Box.** A packaging with complete rectangular or polygonal faces, made of metal, wood, plywood, reconstituted wood, fiberboard, plastic, or other suitable material. Holes appropriate to the size and use of the packaging, for purposes such as ease of handling or opening, or to meet classification requirements, are permitted as long as they do not compromise the integrity of the packaging during transportation, and are not otherwise prohibited. [49 CFR, § 171.8]

**Buddy system.** A system of organizing employees into work groups in such a manner that each employee of the work group is designated to be observed by at least one other employee in the work group. The purpose of the buddy system is to provide rapid assistance to employees in the event of an emergency. [29 CFR 1910.120]





**Branch.** The organizational level having functional or geographical responsibility for major aspects of incident operations. A Branch is organizationally situated between the Section Chief and the Division or Group in the Operations Section, and between the Section and Units in the Logistics Section. Branches are identified by the use of Roman numerals or by functional area. [NIMS 2008]

**Bulk Packaging.** Any packaging, including transport vehicles, having a liquid capacity of more than 119 gal (450 L), a solids capacity of more than 882 lb (400 kg), or a compressed gas water capacity of more than 1001 lb (454 kg). [NFPA® 472, 3.3.44.1]

**Burn.** Refers to either a chemical or thermal burn, the former may be caused by corrosive substances and the latter by liquefied cryogenic gases, hot molten substances, or flames. [ERG 2012]

**CANUTEC.** The Canadian Transport Emergency Center, operated by Transport Canada, which provides emergency response information and assistance on a 24-hour basis for responders to hazardous materials/weapons of mass destruction (WMD) incidents. [NFPA® 472, 3.3.5]

**Carcinogen.** A chemical that falls within any of the following categories: (a) A chemical that has been evaluated by the International Agency for Research on Cancer (IARC) and found to be a carcinogen or potential carcinogen; (b) A chemical that is listed as a carcinogen or potential carcinogen in the latest edition of the National Toxicology Program (NTP) “Report on Carcinogens.” (c) A chemical that is regulated by the Occupational Safety and Health Administration (OSHA) as a carcinogen (can be regulated additionally by states). [NFPA® 472, A.5.2.3(8)]

**Chain of Command.** The orderly line of authority within the ranks of the incident management organization. [NIMS 2008]

**CHEMTREC.** The Chemical Transportation Emergency Response Center, a public service of the American Chemistry Council, which provides emergency response information and assistance on a 24-hour basis for responders to hazardous materials/weapons of mass destruction (WMD) incidents. [NFPA® 472, 3.3.6]

**Chemical Terrorism Agents.** Liquid, solid, gaseous, and vapor chemical warfare agents and toxic industrial chemicals used to inflict lethal or incapacitating casualties, generally on a civilian population as a result of a terrorist attack. [NFPA® 472, A.3.3.29]

**Chemical-Protective Clothing.** Items made from chemical-resistive materials, such as clothing, hood, boots, and gloves, that are designed and configured to protect the wearer’s torso, head, arms, legs, hands, and feet from hazardous materials. [NFPA® 472, 3.3.51.1]

**Chief.** The Incident Command System title for individuals responsible for management of functional Sections: Operations, Planning, Logistics, Finance/Administration, and Intelligence/Investigations (if established as a separate Section). [NIMS 2008]

**Choking Agents.** Substances that cause physical injury to the lungs. Exposure is through inhalation. In extreme cases, membranes swell and lungs become filled with liquid (pulmonary edema). Death results from lack of oxygen; hence, the victim is “choked”. Phosgene (CG) is a choking agent. Symptoms: Irritation to eyes/nose/throat, respiratory distress, nausea and vomiting, burning of exposed skin. [ERG 2012]

**Clean-up operation.** An operation where hazardous substances are removed, contained, incinerated, neutralized, stabilized, cleared-up, or in any other manner processed or handled with the ultimate goal of making the site safer for people or the environment. [29 CFR 1910.120]



**Cold Zone.** (1) The control zone of hazardous materials/weapons of mass destruction (WMD) incidents that contains the incident command post and such other support functions as are deemed necessary to control the incident. [NFPA® 472, 3.3.15.1] (2) Area where the command post and support functions that are necessary to control the incident are located. This is also referred to as the clean zone, green zone or support zone in other documents. (EPA Standard Operating Safety Guidelines, OSHA 29 CFR 1910.120, NFPA 472) [ERG 2012]

**Combustible Liquid.** Liquids which have a flash point greater than 60°C (140°F) and below 93°C (200°F). United States regulations permit a flammable liquid with a flash point between 38°C (100°F) and 60°C (140°F) to be reclassified as a combustible liquid.

**Command.** The act of directing, ordering, or controlling by virtue of explicit statutory, regulatory, or delegated authority. [NIMS 2008]

**Command Staff.** The staff who report directly to the Incident Commander, including the Public Information Officer, Safety Officer, Liaison Officer, and other positions as required. They may have an assistant or assistants, as needed. [NIMS 2008]

**Competence.** Possessing knowledge, skills, and judgment needed to perform indicated objectives. [NFPA® 472, 3.3.7]

**Confined Space.** An area large enough and so configured that a member can bodily enter and perform assigned work but which has limited or restricted means for entry and exit and is not designed for continuous human occupancy. [NFPA® 472, 3.3.8]

**Confinement.** Those procedures taken to keep a material, once released, in a defined or local area. [NFPA® 472, 3.3.9]

**Container.** A receptacle used for storing or transporting material of any kind. [NFPA® 472, 3.3.10]

**Containment.** The actions taken to keep a material in its container (e.g., stop a release of the material or reduce the amount being released). [NFPA® 472, 3.3.11]

**Contaminant.** A hazardous material, or the hazardous component of a weapon of mass destruction (WMD), that physically remains on or in people, animals, the environment, or equipment, thereby creating a continuing risk of direct injury or a risk of exposure. [NFPA® 472, 3.3.12]

**Contamination.** The process of transferring a hazardous material, or the hazardous component of a weapon of mass destruction (WMD), from its source to people, animals, the environment, or equipment, that can act as a carrier. [NFPA® 472, 3.3.13]

**Control.** The procedures, techniques, and methods used in the mitigation of hazardous materials/weapons of mass destruction (WMD) incidents, including containment, extinguishment, and confinement. [NFPA® 472, 3.3.14]

**Control Zones.** (1) The areas at hazardous materials/weapons of mass destruction (WMD) incidents within an established/controlled perimeter that are designated based upon safety and the degree of hazard. [NFPA® 472, 3.3.15] (2) Designated areas at hazmat incidents, based on safety and the degree of hazard. Many terms are used to describe control zones; however, in this guidebook, these zones are defined as the hot/exclusion/red/restricted zone, warm/contamination reduction/yellow/limited access zone, and cold/support/green/clean zone. (EPA Standard Operating Safety Guidelines, OSHA 29 CFR 1910.120, NFPA 472) [ERG 2012]

**Core Competencies.** The knowledge, skills, and judgment needed by operations level responders who respond to releases or potential releases of hazardous materials/weapons of mass destruction (WMD). [NFPA® 472, 3.4.2]

**Corrosive.** A chemical that causes visible destruction of or irreversible alterations in living tissue by chemical action at the site of contact. [NFPA® 472, A.5.2.3(8)]



**Critical Infrastructure.** Assets, systems, and networks, whether physical or virtual, so vital to the United States that the incapacitation or destruction of such assets, systems, or networks would have a debilitating impact on security, national economic security, national public health or safety, or any combination of those matters. [NIMS 2008]

**Cross Contamination.** The process by which a contaminant is carried out of the hot zone and contaminates people, animals, the environment, or equipment. [NFPA® 472, 3.3.13.1]

**Cylinder.** A pressure vessel designed for pressures higher than 40 psia and having a circular cross section. It does not include a portable tank, multi-unit tank car tank, cargo tank, or tank car. [49 CFR, § 171.8]

**Cryogenic Liquid.** A refrigerated, liquefied gas that has a boiling point colder than -90°C (-130°F) at atmospheric pressure.

**Dangerous Water Reactive Material.** Produces significant toxic gas when it comes in contact with water. [ERG 2012]

**Decomposition Products.** Products of a chemical or thermal break-down of a substance. [ERG 2012]

**Decontamination.** (1) The physical and/or chemical process of reducing and preventing the spread of contaminants from people, animals, the environment, or equipment involved at hazardous materials/weapons of mass destruction (WMD) incidents. [NFPA® 472, 3.3.17] (2) Decontamination means the removal of hazardous substances from employees and their equipment to the extent necessary to preclude the occurrence of foreseeable adverse health effects. [29 CFR 1910.120] (3) The removal of hazmats from personnel and equipment to the extent necessary to prevent potential adverse health effects. Always avoid direct or indirect contact with hazmats; however, if contact occurs, personnel should be decontaminated as soon as possible. Since the methods used to decontaminate personnel and equipment differ from one chemical to another, contact the chemical manufacturer, through the agencies listed on the inside back cover, to determine the appropriate procedure. Contaminated clothing and equipment should be removed after use and stored in a controlled area (warm/contamination reduction/yellow/limited access zone) until cleanup procedures can be initiated. In some cases, protective clothing and equipment cannot be decontaminated and must be disposed of in a proper manner. [ERG 2012]

**Decontamination Corridor.** The area usually located within the warm zone where decontamination is performed. [NFPA® 472, 3.3.15.2]

**Degradation.** (1) A chemical action involving the molecular breakdown of a protective clothing material or equipment due to contact with a chemical. (2) The molecular breakdown of the spilled or released material to render it less hazardous during control operations. [NFPA® 472, 3.3.18]

**Director.** The Incident Command System title for individuals responsible for supervision of a Branch. [NIMS 2008]

**Dispersal Device.** Any weapon or combination of mechanical, electrical, or pressurized components that is designed, intended, or used to cause death or serious bodily injury through the release, dissemination, or impact of toxic or poisonous chemicals or their precursors, biological agent, toxin or vector, or radioactive material. [NFPA® 472, 3.3.21]

**Division.** The organizational level having responsibility for operations within a defined geographic area. Divisions are established when the number of resources exceeds the manageable span of control of the Section Chief. See Group. [NIMS 2008]

**Drum.** A flat-ended or convex-ended cylindrical packaging made of metal, fiberboard, plastic, plywood, or other suitable materials. This definition also includes packagings of other shapes made of metal or plastic (e.g., round taper-necked packagings or pail-shaped packagings) but does not include cylinders, jerricans, wooden barrels or bulk packagings.



**Dry Chemical.** A preparation designed for fighting fires involving flammable liquids, pyrophoric substances and electrical equipment. Common types contain sodium bicarbonate or potassium bicarbonate. [ERG 2012]

**Edema.** The accumulation of an excessive amount of watery fluid in cells and tissues. Pulmonary edema is an excessive buildup of water in the lungs, for instance, after inhalation of a gas that is corrosive to lung tissue. [ERG 2012]

**Emergency Decontamination.** The physical process of immediately reducing contamination of individuals in potentially life-threatening situations with or without the formal establishment of a decontamination corridor. [NFPA® 472, 3.3.17.1]

**Emergency.** Any incident, whether natural or manmade, that requires responsive action to protect life or property. Under the Robert T. Stafford Disaster Relief and Emergency Assistance Act, an emergency means any occasion or instance for which, in the determination of the President, Federal assistance is needed to supplement State and local efforts and capabilities to save lives and to protect property and public health and safety, or to lessen or avert the threat of a catastrophe in any part of the United States. [NIMS 2008]

**Emergency Management/Response Personnel.** Includes Federal, State, territorial, tribal, substate regional, and local governments, NGOs, private sector-organizations, critical infrastructure owners and operators, and all other organizations and individuals who assume an emergency management role. (Also known as emergency responder.) [NIMS 2008]

**Emergency Operations Center (EOC).** The physical location at which the coordination of information and resources to support incident management (on-scene operations) activities normally takes place. An EOC may be a temporary facility or may be located in a more central or permanently established facility, perhaps at a higher level of organization within a jurisdiction. EOCs may be organized by major functional disciplines (e.g., fire, law enforcement, medical services), by jurisdiction (e.g., Federal, State, regional, tribal, city, county), or by some combination thereof. [NIMS 2008]

**Emergency Response or Responding to Emergencies.** A response effort by employees from outside the immediate release area or by other designated responders (i.e., mutual aid groups, local fire departments, etc.) to an occurrence which results, or is likely to result, in an uncontrolled release of a hazardous substance. Responses to incidental releases of hazardous substances where the substance can be absorbed, neutralized, or otherwise controlled at the time of release by employees in the immediate release area, or by maintenance personnel are not considered to be emergency responses within the scope of this standard. Responses to releases of hazardous substances where there is no potential safety or health hazard (i.e., fire, explosion, or chemical exposure) are not considered to be emergency responses. [29 CFR 1910.120]

**Emergency Response Guidebook (ERG).** A reference book, written in plain language, to guide emergency responders in their initial actions at the incident scene. [NFPA® 472, 3.3.22]

**Emergency Response Plan.** A plan developed by the authority having jurisdiction, with the cooperation of all participating agencies and organizations, that details specific actions to be performed by all personnel who are expected to respond during an emergency. [NFPA® 472, 3.3.48.1]

**Emergency Response Planning Guideline(s) (ERPGs).** Values intended to provide estimates of concentration ranges above which one could reasonably anticipate observing adverse health effects; see ERPG-1, ERPG-2 and ERPG-3.

**ERPG-1.** The maximum airborne concentration below which it is believed nearly all individuals could be exposed for up to 1 hour without experiencing more than mild, transient adverse health effects or without perceiving a clearly defined objectionable odor.



**ERPG-2.** The maximum airborne concentration below which it is believed nearly all individuals could be exposed for up to 1 hour without experiencing or developing irreversible or other serious health effects or symptoms that could impair an individual's ability to take protective action.

**ERPG-3.** The maximum airborne concentration below which it is believed nearly all individuals could be exposed for up to 1 hour without experiencing or developing life-threatening health effects. [ERG 2012]

**Endangered Area.** The actual or potential area of exposure associated with the release of a hazardous material/weapon of mass destruction (WMD). [NFPA® 472, 3.3.23]

**Evacuation.** The organized, phased, and supervised withdrawal, dispersal, or removal of civilians from dangerous or potentially dangerous areas, and their reception and care in safe areas. [NIMS 2008]

**Evaluate.** The process of assessing or judging the effectiveness of a response operation or course of action within the training and capabilities of the emergency responder. [NFPA® 472, 3.3.24]

**Exposure.** The process by which people, animals, the environment, and equipment are subjected to or come in contact with a hazardous material/weapon of mass destruction (WMD). [NFPA® 472, 3.3.26] The magnitude of exposure is dependent primarily on the duration of exposure and the concentration of the hazardous material. This term is also used to describe a person, animal, the environment, or a piece of equipment. The exposure can be external, internal, or both. [NFPA® 472, A.3.3.26]

**Facility.** (1) Any building, structure, installation, equipment, pipe or pipeline (including any pipe into a sewer or publicly owned treatment works), well, pit, pond, lagoon, impoundment, ditch, storage container, motor vehicle, rolling stock, or aircraft, or (2) any site or area where a hazardous substance has been deposited, stored, disposed of, or placed, or otherwise come to be located; but does not include any consumer product in consumer use or any waterborne vessel. [29 CFR 1910.120]

**Finance/Administration Section.** The Incident Command System Section responsible for all administrative and financial considerations surrounding an incident. [NIMS 2008]

**Fissile Material.** Material whose atoms are capable of nuclear fission (capable of being split). [NFPA® 472, 3.3.27]

**Flammable Liquid.** A liquid that has a flash point of 60°C (140°F) or lower. [ERG 2012]

**Flash Point.** Lowest temperature at which a liquid or solid gives off vapor in such a concentration that, when the vapor combines with air near the surface of the liquid or solid, a flammable mixture is formed. Hence, the lower the flash point, the more flammable the material. [ERG 2012]

**Function.** One of the five major activities in the Incident Command System: Command, Operations, Planning, Logistics, and Finance/Administration. A sixth function, Intelligence/Investigations, may be established, if required, to meet incident management needs. The term function is also used when describing the activity involved (e.g., the planning function). [NIMS 2008]

**Gas.** A material which has a vapor pressure greater than 300 kPa (43.5 psia) at 50 °C (122 °F) or is completely gaseous at 20 °C (68 °F) at a standard pressure of 101.3 kPa (14.7 psia).

**General Staff.** A group of incident management personnel organized according to function and reporting to the Incident Commander. The General Staff normally consists of the Operations Section Chief, Planning Section Chief, Logistics Section Chief, and Finance/Administration Section Chief. An Intelligence/Investigations Chief may be established, if required, to meet incident management needs. [NIMS 2008]





**Gross Decontamination.** The phase of the decontamination process during which the amount of surface contaminants is significantly reduced. [NFPA® 472, 3.3.17.2]

**Group.** An organizational subdivision established to divide the incident management structure into functional areas of operation. Groups are composed of resources assembled to perform a special function not necessarily within a single geographic division. See Division. [NIMS 2008]

**Hazard/Hazardous.** (1) Something that is potentially dangerous or harmful, often the root cause of an unwanted outcome. [NIMS 2008] (2) Capable of posing an unreasonable risk to health, safety, or the environment; capable of causing harm. [NFPA® 472, 3.3.28]

**Hazard Class.** The category of hazard assigned to a hazardous material under the definitional criteria of part 173 of 49 CFR and the provisions of the § 172.101 table. A material may meet the defining criteria for more than one hazard class but is assigned to only one hazard class. [49 CFR, § 171.8]

**Hazardous Material.** A substance (either matter—solid, liquid, or gas—or energy) that when released is capable of creating harm to people, the environment, and property, including weapons of mass destruction (WMD) as defined in 18 U.S. Code, Section 2332a, as well as any other criminal use of hazardous materials, such as illicit labs, environmental crimes, or industrial sabotage. [NFPA® 472, 3.3.29]

**Hazardous Materials Branch/Group.** The function within an overall incident management system that deals with the mitigation and control of the hazardous materials/weapons of mass destruction (WMD) portion of an incident. [NFPA® 472, 3.3.30]

**Hazardous Materials Officer.** (NIMS: Hazardous Materials Branch Director/Group Supervisor.) The person who is responsible for directing and coordinating all operations involving hazardous materials/weapons of mass destruction (WMD) as assigned by the incident commander. [NFPA® 472, 3.3.31]

**Hazardous Materials Response Team (HMRT).** (1) An organized group of trained response personnel operating under an emergency response plan and applicable standard operating procedures who perform hazardous material technician level skills at hazardous materials/weapons of mass destruction (WMD) incidents. [NFPA® 472, 3.3.32] (2)

**Hazardous Materials Response (HAZMAT) Team.** An organized group of employees, designated by the employer, who are expected to perform work to handle and control actual or potential leaks or spills of hazardous substances requiring possible close approach to the substance. The team members perform responses to releases or potential releases of hazardous substances for the purpose of control or stabilization of the incident. A HAZMAT team is not a fire brigade nor is a typical fire brigade a HAZMAT team. A HAZMAT team, however, may be a separate component of a fire brigade or fire department. [29 CFR 1910.120]

**Hazardous Materials Safety Officer.** (NIMS: Assistant Safety Officer — Hazardous Material.) The person who works within an incident management system (IMS) (specifically, the hazardous materials branch/group) to ensure that recognized hazardous materials/WMD safe practices are followed at hazardous materials/weapons of mass destruction (WMD) incidents. [NFPA® 472, 3.3.33]

**Hazardous Materials Technician.** Person who responds to hazardous materials/weapons of mass destruction (WMD) incidents using a risk-based response process by which they analyze a problem involving hazardous materials/weapons of mass destruction (WMD), select applicable decontamination procedures, and control a release using specialized protective clothing and control equipment. [NFPA® 472, 3.3.34]





**Hazardous Substance.** Any substance designated or listed under (A) through (D) of this definition, exposure to which results or may result in adverse effects on the health or safety of employees: [A] Any substance defined under section 103(14) of the Comprehensive Environmental Response Compensation and Liability Act (CERCLA) (42 U.S.C. 9601). [B] Any biologic agent and other disease causing agent which after release into the environment and upon exposure, ingestion, inhalation, or assimilation into any person, either directly from the environment or indirectly by ingestion through food chains, will or may reasonably be anticipated to cause death, disease, behavioral abnormalities, cancer, genetic mutation, physiological malfunctions (including malfunctions in reproduction) or physical deformations in such persons or their offspring. [C] Any substance listed by the U.S. Department of Transportation as hazardous materials under 49 CFR 172.101 and appendices; and [D] Hazardous waste as herein defined. [29 CFR 1910.120]

**Hazardous Waste.** [A] A waste or combination of wastes as defined in 40 CFR 261.3, or [B] Those substances defined as hazardous wastes in 49 CFR 171.8. [29 CFR 1910.120]

**Hazardous Waste Operation.** Any operation conducted within the scope of 29 CFR 1910.120.

**Hazardous Waste Site or Site.** Any facility or location within the scope of 29 CFR 1910.120 at which hazardous waste operations take place. [29 CFR 1910.120]

**Hazard Zones (Inhalation Hazard Zones).**

HAZARD ZONE A: Gases: LC<sub>50</sub> of less than or equal to 200 ppm,  
Liquids: V equal to or greater than 500 LC<sub>50</sub> and LC<sub>50</sub> less than or equal to 200 ppm,

HAZARD ZONE B: Gases: LC<sub>50</sub> greater than 200 ppm and less than or equal to 1000 ppm,  
Liquids: V equal to or greater than 10 LC<sub>50</sub>; LC<sub>50</sub> less than or equal to 1000 ppm and  
criteria for Hazard Zone A are not met.

HAZARD ZONE C: LC<sub>50</sub> greater than 1000 ppm and less than or equal to 3000 ppm,

HAZARD ZONE D: LC<sub>50</sub> greater than 3000 ppm and less than or equal to 5000 ppm. [ERG 2012]

**Hazmat.** A hazardous material. [49 CFR, § 171.8]

**Health Hazard.** A chemical or a pathogen where acute or chronic health effects may occur in exposed employees. It also includes stress due to temperature extremes. The term health hazard includes chemicals that are classified in accordance with the Hazard Communication Standard, 29 CFR 1910.1200, as posing one of the following hazardous effects: Acute toxicity (any route of exposure); skin corrosion or irritation; serious eye damage or eye irritation; respiratory or skin sensitization; germ cell mutagenicity; carcinogenicity; reproductive toxicity; specific target organ toxicity (single or repeated exposure); aspiration toxicity or simple asphyxiant. (See Appendix A to § 1910.1200—Health Hazard Criteria (Mandatory) for the criteria for determining whether a chemical is classified as a health hazard.) [29 CFR 1910.120]

**Highly Toxic.** A chemical that falls within any of the following categories: (a) A chemical that has a median lethal dose (LD<sub>50</sub>) of 50 mg or less per kilogram of body weight when administered orally to albino rats weighing between 200 g and 300 g each (b) A chemical that has a median lethal dose (LD<sub>50</sub>) of 200 mg or less per kilogram of body weight when administered by continuous contact for 24 hours (or less if death occurs within 24 hours) with the bare skin of albino rabbits weighing between 2 kg and 3 kg each (c) A chemical that has a median lethal concentration (LD<sub>50</sub>) in air of 200 parts per million by volume or less of gas or vapor, or 2 mg per liter or less of mist, fume, or dust, when administered by continuous inhalation for 1 hour (or less if death occurs within 1 hour) to albino rats weighing between 200 g and 300 g each. [NFPA® 472, A.5.2.3(8)]

**High Temperature–Protective Clothing.** Protective clothing designed to protect the wearer for short-term high temperature exposures. [NFPA® 472, 3.3.51.2]



**Hot Zone.** (1) The control zone immediately surrounding hazardous materials/weapons of mass destruction (WMD) incidents, which extends far enough to prevent adverse effects of hazards to personnel outside the zone. [NFPA® 472, 3.3.15.3] (2) Area immediately surrounding a hazmat incident which extends far enough to prevent adverse effects from released hazmats to personnel outside the zone. This zone is also referred to as exclusion zone, red zone or restricted zone in other documents. (EPA Standard Operating Safety Guidelines, OSHA 29 CFR 1910.120, NFPA 472) [ERG 2012]

**Immediately Dangerous to Life or Health (IDLH).** An atmospheric concentration of any toxic, corrosive or asphyxiant substance that poses an immediate threat to life or would interfere with an individual's ability to escape from a dangerous atmosphere. [29 CFR 1910.120]

**Immiscible.** A material does not mix readily with water. [ERG 2012]

**Improvised Explosive Device (IED).** A bomb that is manufactured from commercial, military or homemade explosives.

**Improvised Nuclear Device (IND).** An illicit nuclear weapon that is bought, stolen, or otherwise obtained from a nuclear state (that is, a national government with nuclear weapons), or a weapon fabricated from fissile material that is capable of producing a nuclear explosion. [NFPA® 472, 3.3.63.1.1]

**Incident.** An emergency involving the release or potential release of hazardous materials/weapons of mass destruction (WMD). [NFPA® 472, 3.3.36] An occurrence, natural or manmade, that requires a response to protect life or property. Incidents can, for example, include major disasters, emergencies, terrorist attacks, terrorist threats, civil unrest, wildland and urban fires, floods, hazardous materials spills, nuclear accidents, aircraft accidents, earthquakes, hurricanes, tornadoes, tropical storms, tsunamis, war-related disasters, public health and medical emergencies, and other occurrences requiring an emergency response. [NIMS 2008]

**Incident Action Plan.** An oral or written plan approved by the incident commander containing general objectives reflecting the overall strategy for managing an incident. [NFPA® 472, 3.3.48.2] An oral or written plan containing general objectives reflecting the overall strategy for managing an incident. It may include the identification of operational resources and assignments. It may also include attachments that provide direction and important information for management of the incident during one or more operational periods. [NIMS 2008]

**Incident Command.** The Incident Command System organizational element responsible for overall management of the incident and consisting of the Incident Commander (either single or unified command structure) and any assigned supporting staff. [NIMS 2008]

**Incident Commander (IC).** The individual responsible for all incident activities, including the development of strategies and tactics and the ordering and the release of resources. [NFPA® 472, 3.3.37] The individual responsible for all incident activities, including the development of strategies and tactics and the ordering and release of resources. The IC has overall authority and responsibility for conducting incident operations and is responsible for the management of all incident operations at the incident site. [NIMS 2008]

**Incident Command Post (ICP).** The field location where the primary functions are performed. The ICP may be co-located with the Incident Base or other incident facilities. [NIMS 2008]

**Incident Command System (ICS).** A management system designed to enable effective and efficient on-scene incident management by integrating a combination of facilities, equipment, personnel, procedures, and communications operating within a common organizational structure. [NFPA® 472, 3.3.38] A standardized on-scene emergency management construct specifically designed to provide an integrated organizational structure that reflects the



complexity and demands of single or multiple incidents, without being hindered by jurisdictional boundaries. ICS is the combination of facilities, equipment, personnel, procedures, and communications operating within a common organizational structure, designed to aid in the management of resources during incidents. It is used for all kinds of emergencies and is applicable to small as well as large and complex incidents. ICS is used by various jurisdictions and functional agencies, both public and private, to organize field-level incident management operations. [NIMS 2008]

**Incident Management System (IMS)**. A plan that defines the roles and responsibilities to be assumed by personnel and the operating procedures to be used in the management and direction of emergency operations to include the incident command system, multi-agency coordination system, training, and management of resources. [NFPA® 472, 3.3.39]

**Incident Objectives**. Statements of guidance and direction needed to select appropriate strategy(s) and the tactical direction of resources. Incident objectives are based on realistic expectations of what can be accomplished when all allocated resources have been effectively deployed. Incident objectives must be achievable and measurable, yet flexible enough to allow strategic and tactical alternatives. [NIMS 2008]

**Inner packaging**. A packaging for which an outer packaging is required for transport. It does not include the inner receptacle of a composite packaging. [49 CFR, § 171.8]

**Intermediate bulk container (IBC)**. A rigid or flexible portable packaging, other than a cylinder or portable tank, which is designed for mechanical handling. Standards for IBCs manufactured in the United States are set forth in subparts N and O of part 178 of this 49 CFR. [49 CFR, § 171.8]

Intermediate packaging means a packaging which encloses an inner packaging or article and is itself enclosed in an outer packaging. [49 CFR, § 171.8]

Intermodal container means a freight container designed and constructed to permit it to be used interchangeably in two or more modes of transport. [49 CFR, § 171.8]

**Intermodal portable tank (IM) portable tank**. A specific class of portable tanks designed primarily for international intermodal use. [49 CFR, § 171.8]

**Irritant**. A chemical that is not corrosive but that causes a reversible inflammatory effect on living tissue by chemical action at the site of contact. [NFPA® 472, A.5.2.3(8)]

**Joint Information Center (JIC)**. A facility established to coordinate all incident-related public information activities. It is the central point of contact for all news media. Public information officials from all participating agencies should co-locate at the JIC. [NIMS 2008]

**Large Spill**. A spill that involves quantities that are greater than 208 liters (55 US gallons) for liquids and greater than 300 kilograms (660 pounds) for solids. [ERG 2012]

**Lethal Concentration 50 (LC<sub>50</sub>)**. The concentration of a material administered by inhalation that is expected to cause the death of 50% of an experimental animal population within a specified time. (Concentration is reported in either ppm or mg/m<sup>3</sup>) [ERG 2012]

**Liaison Officer**: A member of the Command Staff responsible for coordinating with representatives from cooperating and assisting agencies or organizations. [NIMS 2008]

**Liquid Splash-Protective Clothing**. The garment portion of a chemical-protective clothing ensemble that is designed and configured to protect the wearer against chemical liquid splashes but not against chemical vapors or gases. [NFPA® 472, 3.3.51.3]



**Limited quantity.** When specified as such in a section applicable to a particular material, means the maximum amount of a hazardous material for which there is a specific labeling or packaging exception. [49 CFR, § 171.8]

**Liquid.** A material, other than an elevated temperature material, with a melting point or initial melting point of 20 °C (68 °F) or lower at a standard pressure of 101.3 kPa (14.7 psia). A viscous material for which a specific melting point cannot be determined must be subjected to the procedures specified in ASTM D 4359 “Standard Test Method for Determining Whether a Material is Liquid or Solid” (IBR, see 49 CFR § 171.7). [49 CFR, § 171.8]

**Logistics.** The process and procedure for providing resources and other services to support incident management. [NIMS 2008]

**Marking.** A descriptive name, identification number, instructions, cautions, weight, specification, or UN marks, or combinations thereof, required by this subchapter on outer packagings of hazardous materials. [49 CFR, § 171.8]

**Mixture.** A material composed of more than one chemical compound or element. [49 CFR, § 171.8]

**Mode.** Any of the following transportation methods; rail, highway, air, or water. [49 CFR, § 171.8]

**Logistics Section.** The Incident Command System Section responsible for providing facilities, services, and material support for the incident. [NIMS 2008]

**Mass Decontamination.** The physical process of reducing or removing surface contaminants from large numbers of victims in potentially life-threatening situations in the fastest time possible. [NFPA® 472, 3.3.17.3]

**Mass Explosion.** Explosion which affects almost the entire load virtually instantaneously.

**Safety Data Sheet (SDS).** A form, provided by manufacturers and compounders (blenders) of chemicals, containing information about chemical composition, physical and chemical properties, health and safety hazards, emergency response, and waste disposal of the material. [Adapted from NFPA® 472, 3.3.41.]

**Miscible.** A material mixes readily with water. [ERG 2012]

**Mission-Specific Competencies.** The knowledge, skills, and judgment needed by operations level responders who have completed the operations level competencies and who are designated by the authority having jurisdiction to perform mission-specific tasks, such as decontamination, victim/hostage rescue and recovery, evidence preservation, and sampling. [NFPA® 472, 3.4.3]

**Mitigation.** Activities providing a critical foundation in the effort to reduce the loss of life and property from natural and/or man-made disasters by avoiding or lessening the impact of a disaster and providing value to the public by creating safer communities. Mitigation seeks to fix the cycle of disaster damage, reconstruction, and repeated damage. These activities or actions, in most cases, will have a long-term sustained effect. [NIMS 2008]

**Monitoring Equipment.** Instruments and devices used to identify and quantify contaminants. [NFPA® 472, 3.3.42]

**Multi-jurisdictional Incident.** An incident requiring action from multiple agencies that each have jurisdiction to manage certain aspects of an incident. In the Incident Command System, these incidents will be managed under a Unified Command. [NIMS 2008]

**Mutual Aid Agreement or Assistance Agreement.** Written or oral agreement between and among agencies/ organizations and/or jurisdictions that provides a mechanism to quickly obtain emergency assistance in the form of personnel, equipment, materials, and other associated services. The primary objective is to facilitate rapid, short-term deployment of emergency support prior to, during, and/or after an incident. [NIMS 2008]



**National Incident Management System.** A set of principles that provides a systematic, proactive approach guiding government agencies at all levels, nongovernmental organizations, and the private sector to work seamlessly to prevent, protect against, respond to, recover from, and mitigate the effects of incidents, regardless of cause, size, location, or complexity, in order to reduce the loss of life or property and harm to the environment. [NIMS 2008]

**Nerve Agents.** Substances that interfere with the central nervous system. Exposure is primarily through contact with the liquid (via skin and eyes) and secondarily through inhalation of the vapor. Tabun (GA), Sarin (GB), Soman (GD) and VX are nerve agents. Symptoms: Pinpoint pupils, extreme headache, severe tightness in the chest, dyspnea, runny nose, coughing, salivation, unresponsiveness, seizures. [ERG 2012]

**Nonbulk Packaging.** Any packaging having a liquid capacity of 119 gal (450 L) or less, a solids capacity of 882 lb (400 kg) or less, or a compressed gas water capacity of 1001 lb (454 kg) or less. [NFPA® 472, 3.3.44.2]

**Non-Polar.** See Immiscible. [ERG 2012]

**Noxious.** A material may be harmful or injurious to health or physical well-being. [ERG 2012]

**Operations Level Responders.** Persons who respond to hazardous materials/weapons of mass destruction (WMD) incidents for the purpose of implementing or supporting actions to protect nearby persons, the environment, or property from the effects of the release. [NFPA® 472, 3.4.4]

**Operations Level Responders Assigned to Perform Product Control.** Persons, competent at the operations level, who are assigned to implement product control measures at hazardous materials/weapons of mass destruction (WMD) incidents. [NFPA® 472, 3.4.9]

**Operations Level Responders Assigned to Use Personal Protective Equipment During Hazardous Materials/ Weapons of Mass Destruction (WMD) Incidents.** Persons, competent at the operations level, who are assigned to use personal protective equipment at hazardous materials/weapons of mass destruction (WMD) incidents. [NFPA® 472, 3.4.16]

**Operational Period.** The time scheduled for executing a given set of operation actions, as specified in the Incident Action Plan. Operational periods can be of various lengths, although usually they last 12 to 24 hours. [NIMS 2008]

**Operations Section.** The Incident Command System (ICS) Section responsible for all tactical incident operations and implementation of the Incident Action Plan. In ICS, the Operations Section normally includes subordinate Branches, Divisions, and/or Groups. [NIMS 2008]

**Oxidizer.** A chemical which supplies its own oxygen and which helps other combustible material burn more readily. [ERG 2012]

**Oxygen Deficiency.** That concentration of oxygen by volume below which atmosphere supplying respiratory protection must be provided. It exists in atmospheres where the percentage of oxygen by volume is less than 19.5 percent oxygen. [29 CFR 1910.120]

**Packaging.** Any container that holds a material (hazardous or nonhazardous). [NFPA® 472, 3.3.44]

**Packing Group (PG).** The Packing Group is assigned based on the degree of danger presented by the hazardous material: PG I : Great danger, PG II : Medium danger, PG III : Minor danger. [ERG 2012]

**Penetration.** The movement of a material through a suit's closures, such as zippers, buttonholes, seams, flaps, or other design features of chemical-protective clothing, and through punctures, cuts, and tears. [NFPA® 472, 3.3.45]





**Permeation.** A chemical action involving the movement of chemicals, on a molecular level, through intact material. [NFPA® 472, 3.3.46]

**Permissible Exposure Limit (PEL).** The exposure, inhalation or dermal permissible exposure limit specified in 29 CFR Part 1910, Subparts G and Z. [29 CFR 1910.120]

**Personal Protective Equipment (PPE).** The equipment provided to shield or isolate a person from the chemical, physical, and thermal hazards that can be encountered at hazardous materials/weapons of mass destruction (WMD) incidents. [NFPA® 472, 3.3.47]

**Personnel Accountability.** The ability to account for the location and welfare of incident personnel. It is accomplished when supervisors ensure that Incident Command System principles and processes are functional and that personnel are working within established incident management guidelines. [NIMS 2008]

**pH.** pH is a value that represents the acidity or alkalinity of a water solution. Pure water has a pH of 7. A pH value below 7 indicates an acid solution (a pH of 1 is extremely acidic). A pH above 7 indicates an alkaline solution (a pH of 14 is extremely alkaline). Acids and alkalis (bases) are commonly referred to as corrosive materials.

**Planned Response.** The incident action plan, with the site safety and control plan, consistent with the emergency response plan and/or standard operating procedures for a specific hazardous materials/weapon of mass destruction (WMD) incident. [NFPA® 472, 3.3.49]

**Planning Section.** The Incident Command System Section responsible for the collection, evaluation, and dissemination of operational information related to the incident, and for the preparation and documentation of the Incident Action Plan. This Section also maintains information on the current and forecasted situation and on the status of resources assigned to the incident. [NIMS 2008]

**Poison Inhalation Hazard (PIH).** Term used to describe gases and volatile liquids that are toxic when inhaled. [ERG 2012]

**Polymerization (P).** A chemical reaction which is generally associated with the production of plastic substances. Basically, the individual molecules of the chemical (liquid or gas) react with each other to produce what can be described as a long chain. These chains can be formed in many useful applications. A well known example is the styrofoam (polystyrene) coffee cup which is formed when liquid molecules of styrene react with each other or polymerize forming a solid, therefore changing the name from styrene to polystyrene (poly means many). [ERG 2012]

**Parts per million (ppm).** 1 ppm equals 1 mL/m<sup>3</sup>

**Predict.** The process of estimating or forecasting the future behavior of a hazardous materials/weapons of mass destruction container and/or its contents within the training and capabilities of the emergency responder. [NFPA® 472, 3.3.50]

**Protective Clothing.** (1) Equipment designed to protect the wearer from heat and/or from hazardous materials, or from the hazardous component of a weapon of mass destruction contacting the skin or eyes. [NFPA® 472, 3.3.51] (2) Includes both respiratory and physical protection. One cannot assign a level of protection to clothing or respiratory devices separately. These levels were accepted and defined by response organizations such as U.S. Coast Guard, NIOSH, and U.S. EPA. Level A: SCBA plus totally encapsulating chemical resistant clothing (permeation resistant). Level B: SCBA plus hooded chemical resistant clothing (splash suit). Level C: Full or half-face respirator plus hooded chemical resistant clothing (splash suit). Level D: Coverall with no respiratory protection. [ERG 2012]

**Public Information Officer.** A member of the Command Staff responsible for interfacing with the public and media and/or with other agencies with incident-related information requirements. [NIMS 2008]





**Pyrophoric.** A material which ignites spontaneously upon exposure to air (or oxygen). [ERG 2012]

**Radiation Authority.** A federal, state/provincial agency or state/province designated official. The responsibilities of this authority include evaluating radiological hazard conditions during normal operations and during emergencies. If the identity and telephone number of the authority are not known by emergency responders, or included in the local response plan, the information can be obtained from the agencies listed on the inside back cover. They maintain a periodically updated list of radiation authorities. [ERG 2012]

**Radiation Dispersal Device (RDD).** A device designed to spread radioactive material through a detonation of conventional explosives or other (non-nuclear) means; also referred to as a “dirty bomb.” [NFPA® 472, 3.3.63.1.2]

**Radiation Exposure Device (RED).** Radioactive material, either as a sealed source or as material within some type of container, or a radiation-generating device, such as an x-ray device, that directly exposes people to ionizing radiation; the term is interchangeable with the term radiological exposure device or radiation emitting device. [NFPA® 472, 3.3.63.1.3]

**Radioactive Materials Packaging.** Any packaging for radioactive materials including excepted packaging, industrial packaging, Type A, Type B, and Type C packaging. [NFPA® 472, 3.3.44.3]

**Radioactivity.** The property of some substances to emit invisible and potentially harmful radiation. [ERG 2012]

**Radiological Particulate Terrorism Agents.** Particles that emit ionizing radiation in excess of normal background levels used to inflict lethal or incapacitating casualties, generally on a civilian population, as the result of a terrorist attack. [NFPA® 472, A.3.3.29]

**Respiratory Protection.** Equipment designed to protect the wearer from the inhalation of contaminants. [NFPA® 472, 3.3.53]

**Response.** That portion of incident management in which personnel are involved in controlling hazardous materials/weapons of mass destruction (WMD) incidents. [NFPA® 472, 3.3.54] Activities that address the short-term, direct effects of an incident. Response includes immediate actions to save lives, protect property, and meet basic human needs. Response also includes the execution of emergency operations plans and of mitigation activities designed to limit the loss of life, personal injury, property damage, and other unfavorable outcomes. As indicated by the situation, response activities include applying intelligence and other information to lessen the effects or consequences of an incident; increased security operations; continuing investigations into nature and source of the threat; ongoing public health and agricultural surveillance and testing processes; immunizations, isolation, or quarantine; and specific law enforcement operations aimed at preempting, interdicting, or disrupting illegal activity, and apprehending actual perpetrators and bringing them to justice. [NIMS 2008]

**Risk-Based Response Process.** Systematic process by which responders analyze a problem involving hazardous materials/weapons of mass destruction (WMD), assess the hazards, evaluate the potential consequences, and determine appropriate response actions based upon facts, science, and the circumstances of the incident. [NFPA® 472, 3.3.55]

**Safely.** To perform the assigned tasks without injury to self or others, to the environment, or to property. [NFPA® 472, 3.3.56]

**Safety Officer.** A member of the Command Staff responsible for monitoring incident operations and advising the Incident Commander on all matters relating to operational safety, including the health and safety of emergency responder personnel. [NIMS 2008]



**Section.** The Incident Command System organizational level having responsibility for a major functional area of incident management (e.g., Operations, Planning, Logistics, Finance/Administration, and Intelligence/Investigations (if established)). The Section is organizationally situated between the Branch and the Incident Command. [NIMS 2008]

**Sensitizer.** A chemical that causes a substantial proportion of exposed people or animals to develop an allergic reaction in normal tissue after repeated exposure to the chemical. [NFPA® 472, A.5.2.3(8)]

**SETIQ.** The Emergency Transportation System for the Chemical Industry in Mexico. [NFPA® 472, 3.3.58]

**Site Safety and Control Plan.** A site safety and control plan should be completed and approved by the hazardous materials officer, the hazardous materials safety officer, and the incident commander for inclusion in the incident action plan. The plan must be briefed to personnel operating within the hot zone by the hazardous materials safety officer or the hazardous materials officer prior to entry mission initiation. The initial site safety and control plan for the first operational period can be written or oral. The plan should be documented as soon as resources allow. [NFPA® 472, 3.3.48.3]

**Small spill.** A spill that involves quantities that are less than 208 liters (55 U.S. Gallons) for liquids and less than 300 kilograms (660 pounds) for solids. [ERG 2012]

**Solid.** A material which is not a gas or a liquid. [49 CFR, § 171.8] [49 CFR, § 171.8]

**Solution.** Any homogeneous liquid mixture of two or more chemical compounds or elements that will not undergo any segregation under conditions normal to transportation. [49 CFR, § 171.8]

**Span of Control.** The number of resources for which a supervisor is responsible, usually expressed as the ratio of supervisors to individuals. Under the National Incident Management System, an appropriate span of control is between 1:3 and 1:7, with optimal being 1:5, or between 1:8 and 1:10 for many large-scale law enforcement operations. [NIMS 2008]

**Special Needs Population.** A population whose members may have additional needs before, during, and after an incident in functional areas, including but not limited to: maintaining independence, communication, transportation, supervision, and medical care. Individuals in need of additional response assistance may include those who have disabilities; who live in institutionalized settings; who are elderly; who are children; who are from diverse cultures, who have limited English proficiency, or who are non-English-speaking; or who are transportation disadvantaged. [NIMS 2008]

**Stabilization.** The point in an incident when the adverse behavior of the hazardous material, or the hazardous component of a weapon of mass destruction (WMD), is controlled. [NFPA® 472, 3.3.60]

**Staging Area.** Temporary location for available resources. A Staging Area can be any location in which personnel, supplies, and equipment can be temporarily housed or parked while awaiting operational assignment. [NIMS 2008]

**Standard Operating Guidelines.** A set of instructions having the force of a directive, covering those features of operations which lend themselves to a definite or standardized procedure without loss of effectiveness. [NIMS 2008]

**Standard Operating Procedure.** A complete reference document or an operations manual that provides the purpose, authorities, duration, and details for the preferred method of performing a single function or a number of interrelated functions in a uniform manner. [NIMS 2008]

**Straight (Solid) Stream.** Method used to apply or distribute water from the end of a hose. The water is delivered under pressure for penetration. In an efficient straight (solid) stream, approximately 90% of the water passes through an imaginary circle 38 cm (15 inches) in diameter at the breaking point. Hose (solid or straight) streams are frequently



used to cool tanks and other equipment exposed to flammable liquid fires, or for washing burning spills away from danger points. However, straight streams will cause a spill fire to spread if improperly used or when directed into open containers of flammable and combustible liquids. [ERG 2012]

**Strategy.** The general plan or direction selected to accomplish incident objectives. [NIMS 2008]

**Structural Fire-Fighting Protective Clothing (SFPC).** The fire-resistant protective clothing normally worn by fire fighters during structural fire-fighting operations, which includes a helmet, coat, pants, boots, gloves, PASS device, and a fire-resistant hood to cover parts of the head and neck not protected by the helmet and respirator facepiece. [NFPA® 472, 3.3.51.4]

**Supervisor.** The Incident Command System title for an individual responsible for a Division or Group. [NIMS 2008]

**Tactics.** The deployment and directing of resources on an incident to accomplish the objectives designated by strategy. [NIMS 2008]

**Task Force.** Any combination of resources assembled to support a specific mission or operational need. All resource elements within a Task Force must have common communications and a designated leader. [NIMS 2008]

**Technical Decontamination.** The planned and systematic process of reducing contamination to a level that is as low as reasonably achievable. [NFPA® 472, 3.3.17.4]

**Termination.** That portion of incident management after the cessation of tactical operations in which personnel are involved in documenting safety procedures, site operations, hazards faced, and lessons learned from the incident. [NFPA® 472, 3.3.61]

**Terrorism.** As defined in the Homeland Security Act of 2002, activity that involves an act that is dangerous to human life or potentially destructive of critical infrastructure or key resources; is a violation of the criminal laws of the United States or of any State or other subdivision of the United States; and appears to be intended to intimidate or coerce a civilian population, to influence the policy of a government by intimidation or coercion, or to affect the conduct of a government by mass destruction, assassination, or kidnapping. [NIMS 2008]

**Threat.** Natural or man-made occurrence, individual, entity, or action that has or indicates the potential to harm life, information, operations, the environment, and/or property. [NIMS 2008]

**Toxic.** A chemical that falls within any of the following categories: (a) A chemical that has a median lethal dose ( $LD_{50}$ ) of more than 50 mg per kilogram but not more than 500 mg per kilogram of body weight when administered orally to albino rats weighing between 200 g and 300 g each; (b) A chemical that has a median lethal dose ( $LD_{50}$ ) of more than 200 mg per kilogram but not more than 1000 mg per kilogram of body weight when administered by continuous contact for 24 hours (or less if death occurs within 24 hours) with the bare skin of albino rabbits weighing between 2 kg and 3 kg each; (c) A chemical that has a median lethal concentration ( $LD_{50}$ ) in air of more than 200 parts per million but not more than 3000 parts per million by volume of gas or vapor or more than 2 mg per liter but not more than 200 mg per liter of mist, fume, or dust, when administered by continuous inhalation for 1 hour (or less if death occurs within 1 hour) to albino rats weighing between 200 g and 300 g each. [NFPA® 472, A.5.2.3(8)]

**Toxic Industrial Chemicals.** Highly toxic solid, liquid, or gaseous chemicals, that have been identified as mass casualty threats that could be used to inflict casualties, generally on a civilian population, during a terrorist attack. [NFPA® 472, A.3.3.29]

**Toxic Inhalation Hazard.** Term used to describe gases and volatile liquids that are toxic when inhaled. (Same as PIH.) [ERG 2012]



**Train consist.** A written record of the contents and location of each rail car in a train. [49 CFR, § 171.8]

**Unified Command (UC).** An Incident Command System application used when more than one agency has incident jurisdiction or when incidents cross political jurisdictions. Agencies work together through the designated members of the UC, often the senior persons from agencies and/or disciplines participating in the UC, to establish a common set of objectives and strategies and a single Incident Action Plan. [NIMS 2008]

**Unintentional Release.** The escape of a hazardous material from a package on an occasion not anticipated or planned. This includes releases resulting from collision, package failures, human error, criminal activity, negligence, improper packing, or unusual conditions such as the operation of pressure relief devices as a result of over-pressurization, overflow or fire exposure. It does not include releases, such as venting of packages, where allowed, and the operational discharge of contents from packages. [49 CFR, § 171.8]

**UN/NA Identification Number.** The four-digit number assigned to a hazardous material/weapon of mass destruction (WMD), which is used to identify and cross-reference products in the transportation mode. [NFPA® 472, 3.3.62]

**Vapor Density.** Weight of a volume of pure vapor or gas (with no air present) compared to the weight of an equal volume of dry air at the same temperature and pressure. A vapor density less than 1 (one) indicates that the vapor is lighter than air and will tend to rise. A vapor density greater than 1 (one) indicates that the vapor is heavier than air and may travel along the ground. [ERG 2012]

**Vapor Pressure.** Pressure at which a liquid and its vapor are in equilibrium at a given temperature. Liquids with high vapor pressures evaporate rapidly.

**Vapor-Protective Clothing.** The garment portion of a chemical-protective clothing ensemble that is designed and configured to protect the wearer against chemical vapors or gases. [NFPA® 472, 3.3.51.5]

**Viscosity.** Measure of a liquid's internal resistance to flow. This property is important because it indicates how fast a material will leak out through holes in containers or tanks. [ERG 2012]

**Volatility.** Refers to the relative rate of evaporation of materials to assume the vapor state. [49 CFR, § 171.8]

**Warm Zone.** (1) The control zone at hazardous materials/weapons of mass destruction (WMD) incidents where personnel and equipment decontamination and hot zone support takes place. [NFPA® 472, 3.3.15.4] (2) Area between Hot and Cold zones where personnel and equipment decontamination and hot zone support take place. It includes control points for the access corridor and thus assists in reducing the spread of contamination. Also referred to as the contamination reduction corridor (CRC), contamination reduction zone (CRZ), yellow zone or limited access zone in other documents. (EPA Standard Operating Safety Guidelines, OSHA 29 CFR 1910.120, NFPA 472) [ERG 2012]

**Water-Sensitive.** Substances which may produce flammable and/or toxic decomposition products upon contact with water. [ERG 2012]

**Water Spray (Fog).** Method or way to apply or distribute water. The water is finely divided to provide for high heat absorption. Water spray patterns can range from about 10 to 90 degrees. Water spray streams can be used to extinguish or control the burning of a fire or to provide exposure protection for personnel, equipment, buildings, etc. (This method can be used to absorb vapors, knockdown vapors or disperse vapors. Direct a water spray (fog), rather than a straight (solid) stream, into the vapor cloud to accomplish any of the above).

Water spray is particularly effective on fires of flammable liquids and volatile solids having flash points above 37.8°C (100°F). Regardless of the above, water spray can be used successfully on flammable liquids with low flash points. The effectiveness depends particularly on the method of application. With proper nozzles, even gasoline spill fires of some types have been extinguished when coordinated hose lines were used to sweep the flames off the surface of the liquid.



Furthermore, water spray carefully applied has frequently been used with success in extinguishing fires involving flammable liquids with high flash points (or any viscous liquids) by causing frothing to occur only on the surface, and this foaming action blankets and extinguishes the fire. [ERG 2012]

**Weapon of Mass Destruction (WMD).** (1) Any destructive device, such as any explosive, incendiary, or poison gas bomb, grenade, rocket having a propellant charge of more than four ounces, missile having an explosive or incendiary charge of more than one quarter ounce (7 grams), mine, or device similar to the preceding description; (2) any weapon involving toxic or poisonous chemicals; (3) any weapon involving a disease organism; or (4) any weapon that is designed to release radiation or radioactivity at a level dangerous to human life. [NFPA® 472, 3.3.63]

**Working Pressure.** For purposes of UN pressure receptacles, means the settled pressure of a compressed gas at a reference temperature of 15 °C (59 °F). [49 CFR, § 171.8]





## APIE: A Risk-Based Response Model

# APIE

## A Risk-Based Response Process

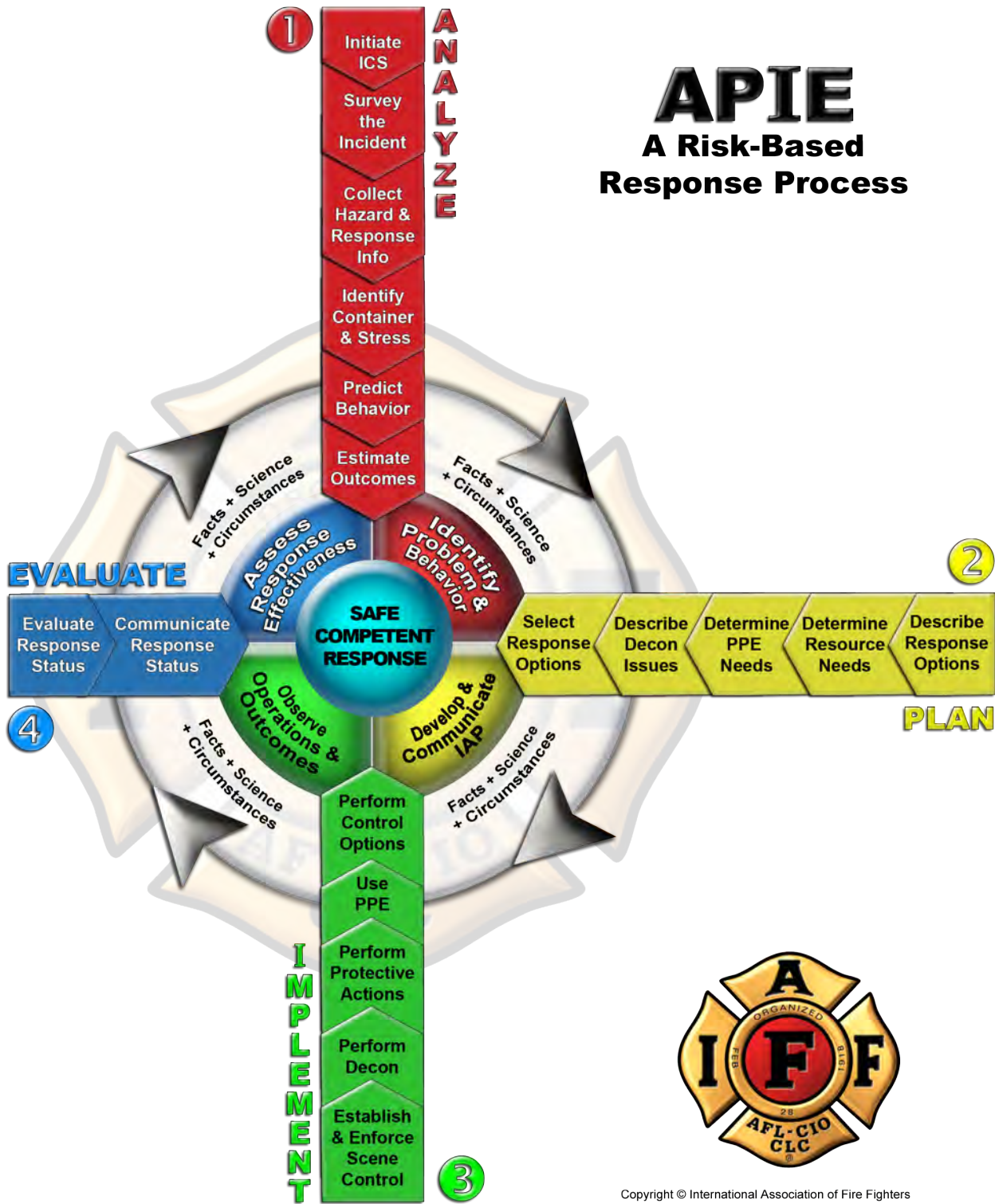

Copyright © International Association of Fire Fighters





## APIE Checklist

### Analyze the Problem *GOAL = Identify the Problem and Likely Behavior*

- Initiate ICS
- Survey the incident
- Collect hazard and response information
- Identify container type and stress
- Predict behavior
- Estimate outcomes

### Plan the Response *GOAL = Develop and Communicate the Incident Action Plan*

- Describe response objectives
- Determine personnel and/or equipment needs
- Determine PPE needs
- Describe decon issues
- Select response options

### Implement the Plan *GOAL = Observe Operations and Outcomes*

- Establish and enforce scene control
  - Secure area
  - Crowd control
  - Traffic control
  - Zones determined
    - Hot
    - Warm
    - Cold
- Set up/perform decon
- Perform protective actions
  - Rescue/recovery
  - Evacuation
  - Shelter-in-place
  - Patient transport
- Use PPE
- Perform control options
- Preserve evidence

### Evaluate the Progress *GOAL = Assess Response Effectiveness*

- Evaluate response status
- Communicate response status



## APIE Worksheet

### Analyze the Problem

GOAL = Identify the Problem and Likely Behavior

Use the *Chemical/Physical Properties Identification Form* (next page) to help you collect the hazard information you'll need to predict behavior of dangerous goods and containers, and estimate outcomes. Use the space below for your notes.

#### Type of Incident

- Fire       Chemical       Biological       Radiological/  
Nuclear       Explosive/  
Incendiary

Initiate ICS \_\_\_\_\_

\_\_\_\_\_

Survey the Incident \_\_\_\_\_

\_\_\_\_\_

Collect Hazard and Response Information \_\_\_\_\_

\_\_\_\_\_

Identify Container Type(s) and Stress \_\_\_\_\_

\_\_\_\_\_

Predict Behavior \_\_\_\_\_

\_\_\_\_\_

Estimate Outcomes \_\_\_\_\_

\_\_\_\_\_



## Chemical/Physical Properties Identification Form

Product/Chemical Names:	References Used:
-------------------------	------------------

### Chemical and Physical Properties

Physical State:	Form:	Vapor Pressure: mmHg/ATM	
Flammable: Yes/No	LEL: %	UEL: %	
Flash Point (FL.P): °F/C	Boiling Point (BP): °F/C		
Ignition (Auto) Temperature: °F/C			
Molecular Weight (MW):	Vapor Density (VD):		
Lighter/Heavier than Air:	Volatility:		
Specific Gravity (Sp. Gr.):	Solubility (SOL):		
Corrosive: pH	Reactive (with):		
Polymerization (potential): Yes/No			
Radioactive: Yes/No	Alpha:	Beta:	Gamma:

### Health

Toxic: Yes/No	Routes of Exposure: Inhalation/Absorption/Ingestion/Injection		
Exposure Limits:	TLV-TWA:	TLV-STEL:	
TLV-C:	PEL:	IDLH:	
Comments:			



## Plan the Response

GOAL = Develop and Communicate the Incident Action Plan

*Use the space below for your notes.*

**Describe Response Objectives** \_\_\_\_\_

---

---

**Determine Personnel and/or Equipment Needs** \_\_\_\_\_

---

---

**Determine PPE Needs** \_\_\_\_\_

---

---

**Describe Decon Issues** \_\_\_\_\_

---

---

**Select Response Objectives** \_\_\_\_\_

---

---



## Implement the Plan

GOAL = Observe Operations and Outcomes

Use the space below for your notes.

**Establish and Enforce Scene Control** \_\_\_\_\_

---

---

**Perform Decon** \_\_\_\_\_

---

---

**Perform Protective Actions** \_\_\_\_\_

---

---

**Use PPE** \_\_\_\_\_

---

---

**Perform Control Options** \_\_\_\_\_

---

---



## Evaluate the Progress

GOAL = Assess Response Effectiveness

*Use the space below for your notes.*

**Evaluate Response Status** \_\_\_\_\_

---

---

---

**Communicate Response Status** \_\_\_\_\_

---

---

---

---





## Performance Checklists

### Checklist #: 472-OPS-001 Emergency Decon (Mandatory)

#### NFPA® 472 Objective

5.4.1(4) Demonstrate the ability to perform emergency decontamination.

#### Performance Requirements

Tasks/Steps	Evaluation Parameters/Performance Outcomes
Listens to the incident action plan and safety briefing provided by the evaluator.	
Dons the PPE provided by the AHJ.	Dons SFPC including SCBA in accordance with SOPs/SOGs of the AHJ.
Selects appropriate tools and equipment.	Provided by the AHJ.
Approaches in a defensive posture.	<ul style="list-style-type: none"><li>Remains uphill, upwind.</li><li>Avoids/minimizes contact with the dangerous good.</li></ul>
Performs emergency decontamination of rescue mannequin or responder.	<ul style="list-style-type: none"><li>Ensures adequate water flow.</li><li>Uses the systematic process of the AHJ (e.g., head-to-toe as well as front to back).</li></ul>
Exits the decontamination area.	Verbalizes: <ul style="list-style-type: none"><li>Decontamination operation is complete.</li><li>The need to transfer care for medical assessment and treatment, if applicable.</li></ul>



## Checklist #: 472-OPS-MS-001 Foam Application/Vapor Suppression

### NFPA® 472 Objectives

- 6.6.4.1(1) Using the type of special purpose or hazard suppressing foams or agents and foam equipment furnished by the AHJ, demonstrate the application of the foam(s) or agent(s) on a spill or fire involving hazardous materials/CBRNE
- 6.6.4.1(3)(j) Given the required tools and equipment, demonstrate how to perform vapor suppression

Tasks/Steps	Evaluation Parameters/Performance Outcomes
Listens to the incident action plan and safety briefing provided by the evaluator.	
Dons and doffs appropriate PPE including SCBA and monitoring equipment throughout the evolution.	Dons SFPC including SCBA in accordance with SOPs/SOGs of the AHJ.
Assembles supplied foam system.	All components are assembled in accordance with the SOPs/SOGs of the AHJ.
Sets the eductor to the appropriate percentage of foam concentration.	Sets as directed by evaluator.
Selects a nozzle and pattern.	Selection based on equipment provided by the AHJ.
Bleeds line and ensures foam is flowing.	
Applies foam.	Applies using directed application technique: <ul style="list-style-type: none"> <li>• Bank-down</li> <li>• Roll-on</li> <li>• Rain-down</li> </ul>
Evaluates the effectiveness of foam application.	Verbalizes effectiveness of foam application.
Exits hazardous area.	Avoids the product and foam blanket.
Proceeds to the decontamination area.	Proceeds to, or verbalizes the need to proceed to, the decontamination area.



### Checklist #: 472-OPS-MS-002 Absorption

#### NFPA® 472 Objective

6.6.4.1(3)(a) Given the required tools and equipment, demonstrate how to perform absorption.

Tasks/Steps	Evaluation Parameters/Performance Outcomes
Listens to the incident action plan and safety briefing provided by the evaluator.	
Dons the PPE provided by the AHJ.	Dons SFPC including SCBA in accordance with SOPs/SOGs of the AHJ.
Selects absorbent material and tools.	Provided by the AHJ.
Approaches in a defensive posture.	<ul style="list-style-type: none"> <li>Remains uphill, upwind.</li> <li>Avoids contact with the dangerous good.</li> </ul>
Prevents product entry into drains.	<ul style="list-style-type: none"> <li>Remains uphill, upwind.</li> <li>Avoids contact with the dangerous good.</li> <li>Places absorbent material to block product entry to drain.</li> </ul>
Deploys absorbent material on the dangerous good.	<ul style="list-style-type: none"> <li>Remains uphill, upwind.</li> <li>Avoids contact with the dangerous good.</li> <li>Covers the dangerous good.</li> </ul>
Evaluates the effectiveness of absorption operation.	Verbalizes effectiveness of the absorption operation.
Exits the hazardous area.	Avoids the product and contaminated absorbent material.
Proceeds to the decontamination area.	Proceeds to, or verbalizes the need to proceed to, the decontamination area.



### Checklist #: 472-OPS-MS-003 Adsorption

#### NFPA® 472 Objective

6.6.4.1(3)(b) Given the required tools and equipment, demonstrate how to perform adsorption.

Tasks/Steps	Evaluation Parameters/Performance Outcomes
Listens to the incident action plan and safety briefing provided by the evaluator.	
Dons the PPE provided by the AHJ.	Dons SFPC including SCBA in accordance with SOPs/SOGs of the AHJ.
Selects adsorbent material and tools.	Provided by the AHJ.
Approaches in a defensive posture.	<ul style="list-style-type: none"> <li>Remains uphill, upwind.</li> <li>Avoids contact with the dangerous good.</li> </ul>
Prevents product entry into drains.	<ul style="list-style-type: none"> <li>Remains uphill, upwind.</li> <li>Avoids contact with the dangerous good.</li> <li>Places adsorbent material to block product entry to drain.</li> </ul>
Deploys adsorbent material on the dangerous good.	<ul style="list-style-type: none"> <li>Remains uphill, upwind.</li> <li>Avoids contact with the dangerous good.</li> <li>Covers the dangerous good.</li> </ul>
Evaluates the effectiveness of adsorption operation.	Verbalizes effectiveness of the adsorption operation.
Exits the hazardous area.	Avoids the product and contaminated adsorbent material.
Proceeds to the decontamination area.	Proceeds to, or verbalizes the need to proceed to, the decontamination area.



### Checklist #: 472-OPS-MS-004 Damming

#### NFPA® 472 Objective

6.6.4.1(3)(c) Given the required tools and equipment, demonstrate how to perform damming.

Tasks/Steps	Evaluation Parameters/Performance Outcomes
Listens to the incident action plan and safety briefing provided by the evaluator.	
Dons the PPE provided by the AHJ.	Dons SFPC including SCBA in accordance with SOPs/SOGs of the AHJ.
Selects appropriate tools and materials for building a dam.	Provided by the AHJ.
Approaches in a defensive posture.	<ul style="list-style-type: none"><li>• Remains uphill, upwind.</li><li>• Avoids contact with the dangerous good.</li></ul>
Constructs a dam.	<ul style="list-style-type: none"><li>• Assesses the terrain for best location for the dam.</li><li>• Creates a dam ahead of the product path.</li><li>• Ensures the dam holds back the product.</li></ul>
Evaluates the effectiveness of damming operation.	Verbalizes effectiveness of the damming operation.
Exits the hazardous area.	Avoids the product and contaminated damming material.
Proceeds to the decontamination area.	Proceeds to, or verbalizes the need to proceed to, the decontamination area.



## Checklist #: 472-OPS-MS-005 Diking

### NFPA® 472 Objective

6.6.4.1(3)(d) Given the required tools and equipment, demonstrate how to perform diking.

Tasks/Steps	Evaluation Parameters/Performance Outcomes
Listens to the incident action plan and safety briefing provided by the evaluator.	
Dons the PPE provided by the AHJ.	Dons SFPC including SCBA in accordance with SOPs/SOGs of the AHJ.
Selects appropriate tools and materials for building a dike.	Provided by the AHJ.
Approaches in a defensive posture.	<ul style="list-style-type: none"> <li>Remains uphill, upwind.</li> <li>Avoids contact with the dangerous good.</li> </ul>
Constructs a dike.	<ul style="list-style-type: none"> <li>Assesses the terrain for best location for the dam.</li> <li>Ensures the dam holds back the product.</li> </ul>
Evaluates the effectiveness of diking operation.	Verbalizes effectiveness of the diking operation.
Exits the hazardous area.	Avoids the product and contaminated diking material.
Proceeds to the decontamination area.	Proceeds to, or verbalizes the need to proceed to, the decontamination area.





### Checklist #: 472-OPS-MS-006 Dilution

#### NFPA® 472 Objective

6.6.4.1(3)(e) Given the required tools and equipment, demonstrate how to perform dilution.

Tasks/Steps	Evaluation Parameters/Performance Outcomes
Listens to the incident action plan and safety briefing provided by the evaluator.	
Dons the PPE provided by the AHJ.	Dons SFPC including SCBA in accordance with SOPs/SOGs of the AHJ.
Selects appropriate tools for dilution.	Provided by the AHJ.
Approaches in a defensive posture.	<ul style="list-style-type: none"><li>Remains uphill, upwind.</li><li>Avoids contact with the dangerous good.</li></ul>
Dilutes the chemical with water.	
Requests the spill area be tested for sufficient reduction of the material.	Verbalizes effectiveness of the dilution operation.
Upon receiving verification of sufficient reduction, exits the hazardous area.	Avoids the product.
Proceeds to the decontamination area.	Proceeds to, or verbalizes the need to proceed to, the decontamination area.



### Checklist #: 472-OPS-MS-007 Diversion

#### NFPA® 472 Objective

6.6.4.1(3)(f) Given the required tools and equipment, demonstrate how to perform diversion.

Tasks/Steps	Evaluation Parameters/Performance Outcomes
Listens to the incident action plan and safety briefing provided by the evaluator.	
Dons the PPE provided by the AHJ.	Dons SFPC including SCBA in accordance with SOPs/SOGs of the AHJ.
Selects appropriate tools for diversion.	Provided by the AHJ.
Approaches in a defensive posture.	<ul style="list-style-type: none"> <li>Remains uphill, upwind.</li> <li>Avoids contact with the dangerous good.</li> </ul>
Constructs a diversion area.	<ul style="list-style-type: none"> <li>Assesses the terrain for best location to construct the diversion area.</li> <li>Selects a direction for the diversion and an area to hold the spill.</li> <li>Starts diversion distant from the spill and works toward the spill.</li> <li>Diverts the product away from drains and waterways.</li> <li>Ensures the dangerous good does not breach the diversion area.</li> </ul>
Evaluates the effectiveness of the diversion operation.	Verbalizes effectiveness of the diversion operation.
Exits the hazardous area.	Avoids the product and contaminated diversion material.
Proceeds to the decontamination area.	Proceeds to, or verbalizes the need to proceed to, the decontamination area.



### Checklist #: 472-OPS-MS-008 Retention

#### NFPA® 472 Objective

6.6.4.1(3)(g) Given the required tools and equipment, demonstrate how to perform retention.

Tasks/Steps	Evaluation Parameters/Performance Outcomes
Listens to the incident action plan and safety briefing provided by the evaluator.	
Dons the PPE provided by the AHJ.	Dons SFPC including SCBA in accordance with SOPs/SOGs of the AHJ.
Selects appropriate tools for retention.	Provided by the AHJ.
Approaches in a defensive posture.	<ul style="list-style-type: none"><li>• Remains uphill, upwind.</li><li>• Avoids contact with the dangerous good.</li></ul>
Constructs a retention area.	<ul style="list-style-type: none"><li>• Avoids contact with the dangerous good.</li><li>• Assesses the terrain for best location for the retention area.</li><li>• Selects an area to retain the spill.</li><li>• Creates a retention area to hold the spill.</li><li>• Retains the product.</li><li>• Ensures the dangerous good does not breach the retention area.</li></ul>
Evaluates the effectiveness of the retention operation.	Verbalizes effectiveness of the retention operation.
Exits the hazardous area.	Avoids the product and contaminated retention material.
Proceeds to the decontamination area.	Proceeds to, or verbalizes the need to proceed to, the decontamination area.



## Checklist #: 472-OPS-MS-009 Remote Valve Shut-Off

### NFPA® 472 Objective

6.6.4.1(3)(g) Given the required tools and equipment, demonstrate how to perform remote valve shut-off.

Tasks/Steps	Evaluation Parameters/Performance Outcomes
Listens to the incident action plan and safety briefing provided by the evaluator.	
Dons the PPE provided by the AHJ.	Dons SFPC including SCBA in accordance with SOPs/SOGs of the AHJ.
Confirms the location of the remote valve.	Verbalizes the location of the remote valve.
Approaches in a defensive posture.	<ul style="list-style-type: none"> <li>Remains uphill, upwind.</li> <li>Avoids contact with the dangerous good.</li> </ul>
Closes the valve.	<ul style="list-style-type: none"> <li>Remains uphill, upwind.</li> <li>Avoids contact with the dangerous good.</li> <li>Confirms the release has been stopped.</li> </ul>
Evaluates the effectiveness of remote valve shut-off operation.	Verbalizes effectiveness of the remote valve shut-off operation.
Exits the hazardous area.	Avoids the product.
Proceeds to the decontamination area.	Proceeds to, or verbalizes the need to proceed to, the decontamination area.



### Checklist #: 472-OPS-MS-010 Vapor Dispersion

#### NFPA® 472 Objective

6.6.4.1(3)(i) Given the required tools and equipment, demonstrate how to perform vapor dispersion.

Tasks/Steps	Evaluation Parameters/Performance Outcomes
Listens to the incident action plan and safety briefing provided by the evaluator.	
Dons the PPE provided by the AHJ.	Dons SFPC including SCBA in accordance with SOPs/SOGs of the AHJ.
Selects appropriate tools for vapor dispersion.	Provided by the AHJ.
Approaches in a defensive posture.	<ul style="list-style-type: none"> <li>Remains uphill, upwind.</li> <li>Deploys the hoseline.</li> <li>Avoids contact with the dangerous good.</li> </ul>
Opens the nozzle to bleed air from the hoseline.	Adjusts nozzle pattern to medium width fog, bleeds air from line prior to entry.
Determines the direction of the water stream.	Selects a safe direction for the water stream.
Uses the hose stream to direct the liquid product or vapors.	<ul style="list-style-type: none"> <li>Works upstream of the product.</li> <li>Ensures the water is not directed into the container.</li> </ul>
Evaluates the effectiveness of the vapor dispersion operation.	Verbalizes effectiveness of the vapor dispersion operation.
Exits the hazardous area.	Avoids the product and contaminated material.
Proceeds to the decontamination area.	Proceeds to, or verbalizes the need to proceed to, the decontamination area.



## Checklist #: 472-OPS-MS-011 PPE

### NFPA® 472 Objective

- 6.2.4.1 (1) Describe at least three safety procedures for personnel wearing protective clothing.  
 (2) Describe at least three emergency procedures for personnel wearing protective clothing.  
 (3) Demonstrate the ability to don, work in, and doff personal protective equipment provided by the AHJ.  
 (5) Describe the maintenance, testing, inspection, storage, and documentation procedures for personal protective equipment provided by the AHJ according to the manufacturer's specifications and recommendations.

Tasks/Steps	Evaluation Parameters/Performance Outcomes
Describes one of the following procedures for the PPE provided by the AHJ: <ul style="list-style-type: none"> <li>• Maintenance</li> <li>• Testing</li> <li>• Inspection</li> <li>• Storage</li> <li>• Documentation</li> </ul>	Responses should match manufacturers operating instructions, local emergency response plans and standard operating procedures/guidelines.
Describes one of the following procedures for wearing the PPE provided by the AHJ: <ul style="list-style-type: none"> <li>• Three safety procedures</li> <li>• Three emergency procedures</li> </ul>	Safety procedures <ul style="list-style-type: none"> <li>• Safety briefing</li> <li>• Buddy system</li> <li>• Back-up team (two-in, two-out)</li> </ul> Emergency procedures <ul style="list-style-type: none"> <li>• Loss of air supply</li> <li>• Loss of suit integrity</li> <li>• Loss of communications</li> <li>• Responder down in the hot zone</li> </ul>
Verifies the SFPC and SCBA are ready for service.	Checks air cylinder pressure, opens cylinder valve, listens for operation of low air alarm, and compares cylinder pressure with remote pressure gauge.
Dons the PPE provided by the AHJ.	Dons SFPC including SCBA in accordance with SOPs/SOGs of the AHJ.
Verifies all personal protective clothing is correctly in place.	Includes helmet with chin strap, hood over face piece harness, no exposed skin, fire fighting gloves with no exposed skin, SCBA harness secure to body.
Performs product control and proceeds to the decontamination area.	In accordance with corresponding IAFF performance checklist.





## Checklist #: 472-OPS-MS-012 Undergoing Technical Decontamination

### NFPA® 472 Objective

6.2.4.1(4) Demonstrate the local procedures for responders undergoing the technical decontamination process.

Tasks/Steps	Evaluation Parameters/Performance Outcomes
Upon completion of mission-specific product control skills station, proceeds to the technical decon corridor.	Wearing SFPC including SCBA in accordance with SOPs/SOGs of the AHJ.
Proceeds to the tool drop.	Places tools in the container provided.
Proceeds to the gross (or primary) wash.	Undergoes gross wash.
Proceeds to the secondary wash station.	In accordance with SOPs/SOGs of the AHJ.
Proceeds to monitoring.	If contamination is detected, follows SOPs/SOGs regarding repeated decontamination or a change of decontamination method.
Proceeds to the suit and SCBA removal station.	<ul style="list-style-type: none"><li>Removes outer PPE and places PPE in the waste container provided.</li><li>Removes respiratory protection, removing the face-piece last.</li></ul>
Proceeds to the dry and dress station.	Avoids contact with runoff water.
Exits the decontamination area.	Verbalizes: <ul style="list-style-type: none"><li>Decontamination operation is complete.</li><li>The need for medical assessment.</li></ul>



## United Nations' Globally Harmonized System of Classification

### OSHA Fact Sheet on Training Requirements

# OSHA<sup>®</sup> FactSheet

## December 1<sup>st</sup>, 2013 Training Requirements for the Revised Hazard Communication Standard

OSHA revised its Hazard Communication Standard (HCS) to align with the United Nations' Globally Harmonized System of Classification and Labeling of Chemicals (GHS) and published it in the Federal Register in March 2012 (77 FR 17574). Two significant changes contained in the revised standard require the use of new labeling elements and a standardized format for Safety Data Sheets (SDSs), formerly known as, Material Safety Data Sheets (MSDSs). The new label elements and SDS requirements will improve worker understanding of the hazards associated with the chemicals in their workplace. To help companies comply with the revised standard, OSHA is phasing in the specific requirements over several years (December 1, 2013 to June 1, 2016).

The first compliance date of the revised HCS is December 1, 2013. By that time employers must have trained their workers on the new label elements and the SDS format. This training is needed early in the transition process since workers are already beginning to see the new labels and SDSs on the chemicals in their workplace. To ensure employees have the information they need to better protect themselves from chemical hazards in the workplace during the transition period, it is critical that employees understand the new label and SDS formats.

The list below contains the minimum required topics for the training that must be completed by December 1, 2013.

- Training on label elements must include information on:
  - Type of information the employee would expect to see on the new labels, including the
    - ✓ **Product identifier:** how the hazardous chemical is identified. This can be (but is not limited to) the chemical name, code number or batch number. The manufacturer, importer or distributor can decide the appropriate product identifier. The same product identifier must be both on the label and in Section 1 of the SDS (Identification).
    - ✓ **Signal word:** used to indicate the relative level of severity of hazard and alert the reader to a potential hazard on the label. There are only two signal words, "Danger"

and "Warning." Within a specific hazard class, "Danger" is used for the more severe hazards and "Warning" is used for the less severe hazards. There will only be one signal word on the label no matter how many hazards a chemical may have. If one of the hazards warrants a "Danger" signal word and another warrants the signal word "Warning," then only "Danger" should appear on the label.

- ✓ **Pictogram:** OSHA's required pictograms must be in the shape of a square set at a point and include a black hazard symbol on a white background with a red frame sufficiently wide enough to be clearly visible. A square red frame set at a point without a hazard symbol is not a pictogram and is not permitted on the label. OSHA has designated eight pictograms under this standard for application to a hazard category.
- ✓ **Hazard statement(s):** describe the nature of the hazard(s) of a chemical, including, where appropriate, the degree of hazard. For example: "Causes damage to kidneys through prolonged or repeated exposure when absorbed through the skin." All of the applicable hazard statements must appear on the label. Hazard statements may be combined where appropriate to reduce redundancies and improve readability. The hazard statements are specific to the hazard



classification categories, and chemical users should always see the same statement for the same hazards, no matter what the chemical is or who produces it.

- ✓ **Precautionary statement(s):** means a phrase that describes recommended measures that should be taken to minimize or prevent adverse effects resulting from exposure to a hazardous chemical or improper storage or handling.
- ✓ **Name, address and phone number of the chemical manufacturer, distributor, or importer**
- How an employee might use the labels in the workplace. For example,
  - ✓ Explain how information on the label can be used to ensure proper storage of hazardous chemicals.
  - ✓ Explain how the information on the label might be used to quickly locate information on first aid when needed by employees or emergency personnel.
- General understanding of how the elements work together on a label. For example,
  - ✓ Explain that where a chemical has multiple hazards, different pictograms are used to identify the various hazards. The employee should expect to see the appropriate pictogram for the corresponding hazard class.
  - ✓ Explain that when there are similar precautionary statements, the one providing the most protective information will be included on the label.
- Training on the format of the SDS must include information on:
  - Standardized 16-section format, including the type of information found in the various sections

- ✓ For example, the employee should be instructed that with the new format, Section 8 (Exposure Controls/Personal Protection) will always contain information about exposure limits, engineering controls and ways to protect yourself, including personal protective equipment.
- How the information on the label is related to the SDS
  - ✓ For example, explain that the precautionary statements would be the same on the label and on the SDS.

As referenced in [Dr. Michaels' OSHA Training Standards Policy Statement \(April 28, 2010\)](#) – with all training, OSHA requires employers to present information in a manner and language that their employees can understand. If employers customarily need to communicate work instructions or other workplace information to employees in a language other than English, they will also need to provide safety and health training to employees in the same manner. Similarly, if the employee's vocabulary is limited, the training must account for that limitation. By the same token, if employees are not literate, telling them to read training materials will not satisfy the employer's training obligation.

OSHA's Hazard Communication website (<http://www.osha.gov/dsg/hazcom/index.html>) has the following QuickCards and OSHA Briefs to assist employers with the required training.

- Label QuickCard ([English/Spanish](#))
- Pictogram QuickCard ([English/Spanish](#))
- Safety Data Sheet QuickCard ([English](#)) ([Spanish](#))
- [Safety Data Sheet OSHA Brief](#)
- Label/Pictogram OSHA Brief (to come)

**This is one in a series of informational fact sheets highlighting OSHA programs, policies or standards. It does not impose any new compliance requirements. For a comprehensive list of compliance requirements of OSHA standards or regulations, refer to Title 29 of the Code of Federal Regulations. This information will be made available to sensory-impaired individuals upon request. The voice phone is (202) 693-1999; teletypewriter (TTY) number: (877) 889-5627.**

**For assistance, contact us. We can help. It's confidential.**



U.S. Department of Labor  
[www.osha.gov](http://www.osha.gov) (800) 321-OSHA (6742)

DSG FS-3642 02/2013



## OSHA Brief on Hazard Communication Standard: Labels and Pictograms

# OSHA<sup>®</sup> BRIEF

## Hazard Communication Standard: Labels and Pictograms

OSHA has adopted new hazardous chemical labeling requirements as a part of its recent revision of the Hazard Communication Standard, 29 CFR 1910.1200 (HCS), bringing it into alignment with the United Nations' Globally Harmonized System of Classification and Labelling of Chemicals (GHS). These changes will help ensure improved quality and consistency in the classification and labeling of all chemicals, and will also enhance worker comprehension. As a result, workers will have better information available on the safe handling and use of hazardous chemicals, thereby allowing them to avoid injuries and illnesses related to exposures to hazardous chemicals.

The revised HCS changes the existing Hazard Communication Standard (HCS/HazCom 1994<sup>1</sup>) from a performance-based standard to one that has more structured requirements for the labeling of chemicals. The revised standard requires that information about chemical hazards be conveyed on labels using quick visual notations to alert the user, providing immediate recognition of the hazards. Labels must also provide instructions on how to handle the chemical so that chemical users are informed about how to protect themselves.

The label provides information to the workers on the specific hazardous chemical. While labels provide important information for anyone who handles, uses, stores, and transports hazardous chemicals, they are limited by design in the amount of information they can provide. Safety Data Sheets (SDSs), which must accompany hazardous chemicals, are the more complete resource for details regarding hazardous chemicals. The revised

standard also requires the use of a 16-section safety data sheet format, which provides detailed information regarding the chemical. There is a separate [OSHA Brief on SDSs](#) that provides information on the new SDS requirements.

All hazardous chemicals shipped after June 1, 2015, must be labeled with specified elements including pictograms, signal words and hazard and precautionary statements. However, manufacturers, importers, and distributors may start using the new labeling system in the revised HCS before the June 1, 2015 effective date if they so choose. Until the June 1, 2015 effective date, manufacturers, importers and distributors may maintain compliance with the requirements of HazCom 1994 or the revised standard. Distributors may continue to ship containers labeled by manufacturers or importers (but not by the distributor themselves) in compliance with the HazCom 1994 until December 1, 2015.

This document is designed to inform chemical receivers, chemical purchasers, and trainers about the label requirements. It explains the new labeling elements, identifies what goes on a label, and describes what pictograms are and how to use them.

### Label Requirements

Labels, as defined in the HCS, are an appropriate group of written, printed or graphic informational elements concerning a hazardous chemical that are affixed to, printed on, or attached to the immediate container of a hazardous chemical, or to the outside packaging.

The HCS requires chemical manufacturers, importers, or distributors to ensure that each container of hazardous chemicals leaving the workplace is labeled, tagged or marked with the following information: product identifier; signal word; hazard statement(s); precautionary

<sup>1</sup> Prior to the 2012 update, the Hazard Communication Standard had last been amended in 1994. 'HazCom 1994' refers to the version of the Hazard Communication Standard in effect directly prior to the 2012 revision, printed in the 1995 through 2011 versions of the Code of Federal Regulations. It is also available on OSHA's webpage.



statement(s); and pictogram(s); and name, address and telephone number of the chemical manufacturer, importer, or other responsible party.

#### Labels for a hazardous chemical must contain:

- Name, Address and Telephone Number
- Product Identifier
- Signal Word
- Hazard Statement(s)
- Precautionary Statement(s)
- Pictogram(s)

To develop labels under the revised HCS, manufacturers, importers and distributors must first identify and classify the chemical hazard(s). Appendices A, B, and C are all mandatory. The classification criteria for health hazards are in Appendix A and the criteria for physical hazards are presented in Appendix B of the revised Hazard Communication Standard. After classifying the hazardous chemicals, the manufacturer, importer or distributor then consults Appendix C to determine the appropriate pictograms, signal words, and hazard and precautionary statement(s), for the chemical label. Once this information has been identified and gathered, then a label may be created.

#### Label Elements

The HCS now requires the following elements on labels of hazardous chemicals:

- **Name, Address and Telephone Number** of the chemical manufacturer, importer or other responsible party.
- **Product Identifier** is how the hazardous chemical is identified. This can be (but is not limited to) the chemical name, code number or batch number. The manufacturer, importer or distributor can decide the appropriate product identifier. The same product identifier must be both on the label and in section 1 of the SDS.
- **Signal Words** are used to indicate the relative level of severity of the hazard and

alert the reader to a potential hazard on the label. There are only two words used as signal words, "Danger" and "Warning." Within a specific hazard class, "Danger" is used for the more severe hazards and "Warning" is used for the less severe hazards. There will only be one signal word on the label no matter how many hazards a chemical may have. If one of the hazards warrants a "Danger" signal word and another warrants the signal word "Warning," then only "Danger" should appear on the label.

- **Hazard Statements** describe the nature of the hazard(s) of a chemical, including, where appropriate, the degree of hazard. For example: "Causes damage to kidneys through prolonged or repeated exposure when absorbed through the skin." All of the applicable hazard statements must appear on the label. Hazard statements may be combined where appropriate to reduce redundancies and improve readability. The hazard statements are specific to the hazard classification categories, and chemical users should always see the same statement for the same hazards no matter what the chemical is or who produces it.
- **Precautionary Statements** describe recommended measures that should be taken to minimize or prevent adverse effects resulting from exposure to the hazardous chemical or improper storage or handling. There are four types of precautionary statements: prevention (to minimize exposure); response (in case of accidental spillage or exposure emergency response, and first-aid); storage; and disposal. For example, a chemical presenting a specific target organ toxicity (repeated exposure) hazard would include the following on the label: "Do not breathe dust/fume/gas/mist/vapors/spray. Get medical advice/attention if you feel unwell. Dispose of contents/container in accordance with local/regional/national and international regulations."

A forward slash (/) designates that the classifier can choose one of the precautionary statements. In the example





above, the label could state, “Do not breathe vapors or spray. Get medical attention if you feel unwell. Dispose of contents in accordance with local/regional/national/international regulations.” See Examples 1 and 2A of this document as an example.

In most cases, the precautionary statements are independent. However, OSHA does allow flexibility for applying precautionary statements to the label, such as combining statements, using an order of precedence or eliminating an inappropriate statement.

Precautionary statements may be combined on the label to save on space and improve readability. For example, “Keep away from heat, spark and open flames,” “Store in a well-ventilated place,” and “Keep cool” may be combined to read: “Keep away from heat, sparks and open flames and store in a cool, well-ventilated place.” Where a chemical is classified for a number of hazards and the precautionary statements are similar, the most stringent statements must be included on the label. In this case, the chemical manufacturer, importer, or distributor may impose an order of precedence where phrases concerning response require rapid action to ensure the health and safety of the exposed person. In the self-reactive hazard category Types C, D, E or F, three of the four precautionary statements for prevention are:

- “Keep away from heat/sparks/open flame/hot surfaces. - No Smoking.”;
- “Keep/Store away from clothing/.../combustible materials”;
- “Keep only in original container.”

These three precautionary statements could be combined to read: “Keep in original container and away from heat, open flames, combustible materials and hot surfaces. - No Smoking.”

Finally, a manufacturer or importer may eliminate a precautionary statement if

it can demonstrate that the statement is inappropriate.

- **Supplementary Information.** The label producer may provide additional instructions or information that it deems helpful. It may also list any hazards not otherwise classified under this portion of the label. This section must also identify the percentage of ingredient(s) of unknown acute toxicity when it is present in a concentration of  $\geq 1\%$  (and the classification is not based on testing the mixture as a whole). If an employer decides to include additional information regarding the chemical that is above and beyond what the standard requires, it may list this information under what is considered “supplementary information.” There is also no required format for how a workplace label must look and no particular format an employer has to use; however, it cannot contradict or detract from the required information.

An example of an item that may be considered supplementary is the personal protective equipment (PPE) pictogram indicating what workers handling the chemical may need to wear to protect themselves. For example, the Hazardous Materials Information System (HMIS) pictogram of a person wearing goggles may be listed. Other supplementary information may include directions of use, expiration date, or fill date, all of which may provide additional information specific to the process in which the chemical is used.

- Pictograms are graphic symbols used to communicate specific information about the hazards of a chemical. On hazardous chemicals being shipped or transported from a manufacturer, importer or distributor, the required pictograms consist of a red square frame set at a point with a black hazard symbol on a white background, sufficiently wide to be clearly visible. A square red frame set at a point without a hazard symbol is not a pictogram and is not permitted on the label.







The pictograms OSHA has adopted improve worker safety and health, conform with the GHS, and are used worldwide.





While the GHS uses a total of nine pictograms, OSHA will only enforce the use of eight. The environmental pictogram is not mandatory but may be used to provide additional information. Workers may see the ninth symbol on a label because label preparers may choose to add the environment pictogram as supplementary information. Figure 1 shows the symbol for each pictogram, the written name for each pictogram, and the hazards associated with each of the pictograms. Most of the symbols are already used for transportation and many chemical users may be familiar with them.

**Figure 1: Pictograms and Hazards**

<p><b>Health Hazard</b></p>  <ul style="list-style-type: none"> <li>• Carcinogen</li> <li>• Mutagenicity</li> <li>• Reproductive Toxicity</li> <li>• Respiratory Sensitizer</li> <li>• Target Organ Toxicity</li> <li>• Aspiration Toxicity</li> </ul>	<p><b>Flame</b></p>  <ul style="list-style-type: none"> <li>• Flammables</li> <li>• Pyrophorics</li> <li>• Self-Heating</li> <li>• Emits Flammable Gas</li> <li>• Self-Reactives</li> <li>• Organic Peroxides</li> </ul>	<p><b>Exclamation Mark</b></p>  <ul style="list-style-type: none"> <li>• Irritant (skin and eye)</li> <li>• Skin Sensitizer</li> <li>• Acute Toxicity (harmful)</li> <li>• Narcotic Effects</li> <li>• Respiratory Tract Irritant</li> <li>• Hazardous to Ozone Layer (Non-Mandatory)</li> </ul>
<p><b>Gas Cylinder</b></p>  <ul style="list-style-type: none"> <li>• Gases Under Pressure</li> </ul>	<p><b>Corrosion</b></p>  <ul style="list-style-type: none"> <li>• Skin Corrosion/ Burns</li> <li>• Eye Damage</li> <li>• Corrosive to Metals</li> </ul>	<p><b>Exploding Bomb</b></p>  <ul style="list-style-type: none"> <li>• Explosives</li> <li>• Self-Reactives</li> <li>• Organic Peroxides</li> </ul>
<p><b>Flame Over Circle</b></p>  <ul style="list-style-type: none"> <li>• Oxidizers</li> </ul>	<p><b>Environment (Non-Mandatory)</b></p>  <ul style="list-style-type: none"> <li>• Aquatic Toxicity</li> </ul>	<p><b>Skull and Crossbones</b></p>  <ul style="list-style-type: none"> <li>• Acute Toxicity (fatal or toxic)</li> </ul>

It is important to note that the OSHA pictograms do not replace the diamond-shaped labels that the U.S. Department of Transportation (DOT) requires for the transport of chemicals, including chemical drums, chemical totes, tanks or other containers. Those labels must be on the external part of a shipped container and must meet the

DOT requirements set forth in 49 CFR 172, Subpart E. If a label has a DOT transport pictogram, Appendix C.2.3.3 states that the corresponding HCS pictogram shall not appear. However, DOT does not view the HCS pictogram as a conflict and for some international trade both pictograms may need to be present on the label. Therefore, OSHA intends to revise C.2.3.3. In the meantime, the agency will allow both DOT and HCS pictograms for the same hazard on a label. While the DOT diamond label is required for all hazardous chemicals on the outside shipping containers, chemicals in smaller containers inside the larger shipped container do not require the DOT diamond but do require the OSHA pictograms. (See Example 2.)

Labels must be legible, in English, and prominently displayed. Other languages may be displayed in addition to English. Chemical manufacturers, importers, and distributors who become newly aware of any significant information regarding the hazards of a chemical must revise the label within six months.

### Employer Responsibilities

Employers are responsible for maintaining the labels on the containers, including, but not limited to, tanks, totes, and drums. This means that labels must be maintained on chemicals in a manner which continues to be legible and the pertinent information (such as the hazards and directions for use) does not get defaced (i.e., fade, get washed off) or removed in any way.

The employer is not responsible for updating labels on shipped containers, even if the shipped containers are labeled under HazCom 1994. The employer must relabel items if the labels are removed or defaced. However, if the employer is aware of newly-identified hazards that are not disclosed on the label, the employer must ensure that the workers are aware of the hazards as discussed below under workplace labels.

### Workplace Labels

OSHA has not changed the general requirements for workplace labeling. Employers have the option to create their own workplace labels. They can either provide all of the required information that is on the



label from the chemical manufacturer or, the product identifier and words, pictures, symbols or a combination thereof, which in combination with other information immediately available to employees, provide specific information regarding the hazards of the chemicals.

If an employer has an in-plant or workplace system of labeling that meets the requirements of HazCom 1994, the employer may continue to use this system in the workplace as long as this system, in conjunction with other information immediately available to the employees, provides the employees with the information on all of the health and physical hazards of the hazardous chemical. This workplace labeling system may include signs, placards, process sheets, batch tickets, operating procedures, or other such written materials to identify hazardous chemicals. Any of these labeling methods or a combination thereof may be used instead of a label from the manufacturer, importer or distributor as long as the employees have immediate access to all of the information about the hazards of the chemical. Workplace labels must be in English. Other languages may be added to the label if applicable.

If the employer chooses to use the pictograms that appear in Appendix C on the workplace (or in-plant) labels, these pictograms may have a black border, rather than a red border.

Employers may use additional instructional symbols that are not included in OSHA's HCS pictograms on the workplace labels. An example of an instructional pictogram is a person with goggles, denoting that goggles must be worn while handling the given chemical. Including both types of pictograms on workplace labels is acceptable. The same is true if the employer wants to list environmental pictograms or PPE pictograms from the HMIS to identify protective measures for those handling the chemical.

Employers may continue to use rating systems such as National Fire Protection Association (NFPA) diamonds or HMIS requirements for workplace labels as long as they are consistent with the requirements of the Hazard Communication Standard and the employees have immediate access to the specific hazard

information as discussed above. An employer using NFPA or HMIS labeling must, through training, ensure that its employees are fully aware of the hazards of the chemicals used.

If an employer transfers hazardous chemicals from a labeled container to a portable container that is only intended for immediate use by the employee who performs the transfer, no labels are required for the portable container.

### Sample Labels

The following examples demonstrate how a manufacturer or importer may display the appropriate information on the label. As mentioned above, once the manufacturer determines the classification of the chemical (class and category of each hazard) using Appendices A and B, it would determine the required pictograms, signal words, hazard statements, and precautionary statements using Appendix C. The final step is to put the information on the label.

The examples below show what a sample label might look like under the revised HCS requirements. The examples break the labeling out into "steps" to show the order of information gathering and how label creation occurs. Step 1 is performing classification; step 2 is gathering full label information; and step 3 is creating the label.

These examples are for informational purposes only and are not meant to represent the only labels manufacturers, importers and distributors may create for these hazards.



**Example 1: This example demonstrates a simple label.**

**The Substance:**

HS85  
Batch Number: 85L6543

**Step 1: Perform Classification**

Class: Acute Oral Toxicity; Category 4

**Step 2: Gather Labeling Information**

Pictograms:



**Signal Word:**

WARNING

**Hazard Statements:**

Harmful if Swallowed

**Precautionary Statements:**

Prevention:

- Wash hands and face thoroughly after handling.
- Do not eat, drink or smoke when using this product.

Response:

- If swallowed: Call a doctor if you feel unwell.<sup>2</sup>
- Rinse mouth

Storage:

None specified

Disposal:

- Dispose of contents/container in accordance with local/regional/national/international regulations.<sup>3</sup>

**Step 3: Create the Label**

Putting together the above information on HS85, a label might list the following information:

**Example 1: HS85 Label**

**HS85**  
Batch number: 85L6543



**Warning**  
Harmful if swallowed

Wash hands and face thoroughly after handling. Do not eat, drink or smoke when using this product. Dispose of contents/container in accordance with local, state and federal regulations.

**First aid:**  
If swallowed: Call a doctor if you feel unwell. Rinse mouth.

GHS Example Company, 123 Global Circle, Anyville, NY 130XX Telephone (888) 888-8888

<sup>2</sup> The manufacturer of this chemical determined that calling a doctor was the most appropriate emergency medical advice; therefore, it is listed as part of the first-aid procedures.

<sup>3</sup> The downstream users must familiarize themselves with the proper disposal methods in accordance with local, regional, state and federal regulations. It is impractical to expect the label preparer to list all potential regulations that exist.



## Example 2: This example demonstrates a more complex label.

Example 2 is for a substance that is a severe physical and health hazard. For shipping packages of chemicals that will be transported in the United States (i.e., drums, totes, tanks, etc.), the U.S. DOT requires a DOT label(s) on the outside container(s) for hazardous chemicals. Two versions of this label are presented below to demonstrate the difference between an OSHA label with pictograms from the HCS and a DOT label required for transport of a shipping container.

### The Substance:

OXI252 (disodiumflammy)  
CAS number: 111-11-11xx

### Step 1: Perform Classification

Class: Oxidizing Solid, Category 1  
Class: Skin Corrosive, Category 1A

### Step 2: Gather Labeling Information

#### Pictograms:



#### Signal Word:

DANGER

#### Hazard Statements:

- May cause fire or explosion; strong oxidizer
- Causes severe skin burns and eye damage

#### Precautionary Statements:

##### Prevention:

- Keep away from heat.
- Keep away from clothing and other combustible materials.
- Take any precaution to avoid mixing with combustibles.
- Wear protective neoprene gloves, safety goggles and face shield with chin guard.
- Wear fire/flame resistant clothing.
- Do not breathe dust or mists.
- Wash arms, hands and face thoroughly after handling.

#### Response:

- IF ON SKIN (or hair): Take off immediately all contaminated clothing. Rinse skin with water.
- IF ON CLOTHING: Rinse immediately contaminated clothing and skin with plenty of water before removing clothes. Wash contaminated clothing before reuse.
- IF IN EYES: Rinse cautiously with water for several minutes. Remove contact lenses, if present and easy to do. Continue rinsing.
- IF INHALED: Remove person to fresh air and keep comfortable for breathing.
- IF SWALLOWED: Rinse mouth. Do NOT induce vomiting.
- Immediately call poison center.<sup>4</sup>

#### Specific Treatment:

Treat with doctor-prescribed burn cream.<sup>5</sup>

#### In case of fire:

Use water spray. In case of major fire and large quantities: Evacuate area. Fight fire remotely due to the risk of explosion.

#### Storage:

Store locked up.

#### Disposal:

- Dispose of contents/container in accordance with local/regional/national/international regulations.<sup>3</sup>

### Step 3: Create the Label

Putting together the above information on OXI252, a label might list the following information:



<sup>4</sup> In this example, the manufacturer determined that calling a poison control center is the most appropriate emergency medical advice.

<sup>5</sup> Not all SDSs will have direction for "specific treatment" on the label. This is only if the manufacturer specifically notes a certain treatment that needs to be used to treat a worker who has been exposed to this chemical.



### Example 2A: OXI252 Label inner package label with OSHA pictograms

**OXI252**  
(disodiumflammy)  
CAS #: 111-11-11xx

**Danger**  
May cause fire or explosion; strong oxidizer  
Causes severe skin burns and eye damage

Keep away from heat. Keep away from clothing and other combustible materials. Take any precaution to avoid mixing with combustibles. Wear protective neoprene gloves, safety goggles and face shield with chin guard. Wear fire/flame resistant clothing. Do not breathe dust or mists. Wash arms, hands and face thoroughly after handling. Store locked up. Dispose of contents and container in accordance with local, state and federal regulations.



**First aid:**  
IF ON SKIN (or hair) or clothing<sup>6</sup>: Rinse immediately contaminated clothing and skin with plenty of water before removing clothes. Wash contaminated clothing before reuse.  
IF IN EYES: Rinse cautiously with water for several minutes. Remove contact lenses, if present and easy to do. Continue rinsing.  
IF INHALED: Remove person to fresh air and keep comfortable for breathing.  
IF SWALLOWED: Rinse mouth. Do NOT induce vomiting.  
Immediately call poison center.  
Specific Treatment: Treat with doctor-prescribed burn cream.

**Fire:**  
In case of fire: Use water spray. In case of major fire and large quantities: Evacuate area. Fight fire remotely due to the risk of explosion.

Great Chemical Company, 55 Main Street, Anywhere, CT 064XX Telephone (888) 777-8888

### Example 2B: OXI252 Label meeting DOT requirements for shipping<sup>7</sup>

**OXI252**  
(disodiumflammy)  
CAS #: 111-11-11xx

**Danger**  
May cause fire or explosion; strong oxidizer  
Causes severe skin burns and eye damage

Keep away from heat. Keep away from clothing and other combustible materials. Take any precaution to avoid mixing with combustibles. Wear protective neoprene gloves, safety goggles and face shield with chin guard. Wear fire/flame resistant clothing. Do not breathe dust or mists. Wash arms, hands and face thoroughly after handling. Store locked up. Dispose of contents and container in accordance with local, state and federal regulations.

**First aid:**  
IF ON SKIN (or hair) or clothing: Rinse immediately contaminated clothing and skin with plenty of water before removing clothes. Wash contaminated clothing before reuse.  
IF IN EYES: Rinse cautiously with water for several minutes. Remove contact lenses, if present and easy to do. Continue rinsing.  
IF INHALED: Remove person to fresh air and keep comfortable for breathing. Immediately call a doctor.  
IF SWALLOWED: Rinse mouth. Do NOT induce vomiting.  
Immediately call poison center.  
Specific Treatment: Treat with doctor-prescribed burn cream.

**Fire:**  
In case of fire: Use water spray. In case of major fire and large quantities: Evacuate area. Fight fire remotely due to the risk of explosion.

Great Chemical Company, 55 Main Street, Anywhere, CT 064XX Telephone (888) 777-8888

<sup>6</sup> There are occasions where label preparers may combine statements on the label. In this case the similar statements were combined and the most stringent were listed. For example, the first-aid pre-

cautionary statements were combined for exposure to skin, hair and clothing.

<sup>7</sup> DOT Labels must comply with the size requirements presented in 49 CFR 172.





For more detailed information about labels and Safety Data Sheets (SDSs) under the revised Hazard Communication Standard, please refer to 29 CFR 1910.1200 - paragraphs (f) and (g), and Appendix C.

The revised Hazard Communication Standard and additional guidance materials are available on OSHA's Hazard Communication page, located at: [www.osha.gov/dsg/hazcom/index.html](http://www.osha.gov/dsg/hazcom/index.html).

Disclaimer: This OSHA Brief provides a general overview of the label requirements in the Hazard Communication Standard (see 29 CFR 1910.1200(f) and Appendix C of 29 CFR 1910.1200). It does not alter or determine compliance responsibilities in the standard or the Occupational Safety and Health Act of 1970. Since interpretations and enforcement policy may change over time, the reader should consult current OSHA interpretations and decisions by the Occupational Safety and Health Review Commission and the courts for additional guidance on OSHA compliance requirements.

**This is one in a series of informational briefs highlighting OSHA programs, policies or standards. It does not impose any new compliance requirements. For a comprehensive list of compliance requirements of OSHA standards or regulations, refer to Title 29 of the Code of Federal Regulations. This information will be made available to sensory-impaired individuals upon request. The voice phone is (202) 693-1999; teletypewriter (TTY) number: (877) 889-5627.**

**For assistance, contact us. We can help. It's confidential.**



U.S. Department of Labor  
[www.osha.gov](http://www.osha.gov) (800) 321-OSHA (6742)

DSG BR-3636 2/2013





## OSHA Brief on Hazard Communication Standard: Safety Data Sheets

# OSHA<sup>®</sup> BRIEF

## Hazard Communication Standard: Safety Data Sheets

The Hazard Communication Standard (HCS) (29 CFR 1910.1200(g)), revised in 2012, requires that the chemical manufacturer, distributor, or importer provide Safety Data Sheets (SDSs) (formerly MSDSs or Material Safety Data Sheets) for each hazardous chemical to downstream users to communicate information on these hazards. The information contained in the SDS is largely the same as the MSDS, except now the SDSs are required to be presented in a consistent user-friendly, 16-section format. This brief provides guidance to help workers who handle hazardous chemicals to become familiar with the format and understand the contents of the SDSs.

The SDS includes information such as the properties of each chemical; the physical, health, and environmental health hazards; protective measures; and safety precautions for handling, storing, and transporting the chemical. The information contained in the SDS must be in English (although it may be in other languages as well). In addition, OSHA requires that SDS preparers provide specific minimum information as detailed in Appendix D of 29 CFR 1910.1200. The SDS preparers may also include additional information in various section(s).

Sections 1 through 8 contain general information about the chemical, identification, hazards, composition, safe handling practices, and emergency control measures (e.g., fire fighting). This information should be helpful to those that need to get the information quickly. Sections 9 through 11 and 16 contain other technical and scientific information, such as physical and chemical properties, stability and reactivity information, toxicological information, exposure control information, and other information including the date of preparation or last revision. The SDS must also state that no applicable information was found when the preparer does not find relevant information for any required element.

The SDS must also contain Sections 12 through 15, to be consistent with the UN Globally Harmonized System of Classification and Labeling of Chemicals (GHS), but OSHA will not enforce the content of these sections because they concern matters handled by other agencies.

A description of all 16 sections of the SDS, along with their contents, is presented below:

### Section 1: Identification

This section identifies the chemical on the SDS as well as the recommended uses. It also provides the essential contact information of the supplier. The required information consists of:

- Product identifier used on the label and any other common names or synonyms by which the substance is known.
- Name, address, phone number of the manufacturer, importer, or other responsible party, and emergency phone number.
- Recommended use of the chemical (e.g., a brief description of what it actually does, such as flame retardant) and any restrictions on use (including recommendations given by the supplier).



## Section 2: Hazard(s) Identification

This section identifies the hazards of the chemical presented on the SDS and the appropriate warning information associated with those hazards. The required information consists of:

- The hazard classification of the chemical (e.g., flammable liquid, category<sup>1</sup>).
- Signal word.
- Hazard statement(s).
- Pictograms (the pictograms or hazard symbols may be presented as graphical reproductions of the symbols in black and white or be a description of the name of the symbol (e.g., skull and crossbones, flame).
- Precautionary statement(s).
- Description of any hazards not otherwise classified.
- For a mixture that contains an ingredient(s) with unknown toxicity, a statement describing how much (percentage) of the mixture consists of ingredient(s) with unknown acute toxicity. Please note that this is a total percentage of the mixture and not tied to the individual ingredient(s).

## Section 3: Composition/Information on Ingredients

This section identifies the ingredient(s) contained in the product indicated on the SDS, including impurities and stabilizing additives. This section includes information on substances, mixtures, and all chemicals where a trade secret is claimed. The required information consists of:

### Substances

- Chemical name.
- Common name and synonyms.
- Chemical Abstracts Service (CAS) number and other unique identifiers.
- Impurities and stabilizing additives, which are themselves classified and which contribute to the classification of the chemical.

### Mixtures

- Same information required for substances.
- The chemical name and concentration (i.e., exact percentage) of all ingredients which are classified as health hazards and are:
  - Present above their cut-off/concentration limits or
  - Present a health risk below the cut-off/concentration limits.
- The concentration (exact percentages) of each ingredient must be specified except concentration ranges may be used in the following situations:
  - A trade secret claim is made,
  - There is batch-to-batch variation, or
  - The SDS is used for a group of substantially similar mixtures.

### Chemicals where a trade secret is claimed

- A statement that the specific chemical identity and/or exact percentage (concentration) of composition has been withheld as a trade secret is required.

<sup>1</sup> Chemical, as defined in the HCS, is any substance, or mixture of substances.



#### Section 4: First-Aid Measures

This section describes the initial care that should be given by untrained responders to an individual who has been exposed to the chemical. The required information consists of:

- Necessary first-aid instructions by relevant routes of exposure (inhalation, skin and eye contact, and ingestion).
- Description of the most important symptoms or effects, and any symptoms that are acute or delayed.
- Recommendations for immediate medical care and special treatment needed, when necessary.

#### Section 5: Fire-Fighting Measures

This section provides recommendations for fighting a fire caused by the chemical. The required information consists of:

- Recommendations of suitable extinguishing equipment, and information about extinguishing equipment that is not appropriate for a particular situation.
- Advice on specific hazards that develop from the chemical during the fire, such as any hazardous combustion products created when the chemical burns.
- Recommendations on special protective equipment or precautions for firefighters.

#### Section 6: Accidental Release Measures

This section provides recommendations on the appropriate response to spills, leaks, or releases, including containment and cleanup practices to prevent or minimize exposure to people, properties, or the environment. It may also include recommendations distinguishing between responses for large and small spills where the spill volume has a significant impact on the hazard. The required information may consist of recommendations for:

- Use of personal precautions (such as removal of ignition sources or providing sufficient ventilation) and protective equipment to prevent the contamination of skin, eyes, and clothing.
- Emergency procedures, including instructions for evacuations, consulting experts when needed, and appropriate protective clothing.
- Methods and materials used for containment (e.g., covering the drains and capping procedures).
- Cleanup procedures (e.g., appropriate techniques for neutralization, decontamination, cleaning or vacuuming; adsorbent materials; and/or equipment required for containment/clean up).

#### Section 7: Handling and Storage

This section provides guidance on the safe handling practices and conditions for safe storage of chemicals. The required information consists of:

- Precautions for safe handling, including recommendations for handling incompatible chemicals, minimizing the release of the chemical into the environment, and providing advice on general hygiene practices (e.g., eating, drinking, and smoking in work areas is prohibited).
- Recommendations on the conditions for safe storage, including any incompatibilities. Provide advice on specific storage requirements (e.g., ventilation requirements).



### Section 8: Exposure Controls/Personal Protection

This section indicates the exposure limits, engineering controls, and personal protective measures that can be used to minimize worker exposure. The required information consists of:

- OSHA Permissible Exposure Limits (PELs), American Conference of Governmental Industrial Hygienists (ACGIH) Threshold Limit Values (TLVs), and any other exposure limit used or recommended by the chemical manufacturer, importer, or employer preparing the safety data sheet, where available.
- Appropriate engineering controls (e.g., use local exhaust ventilation, or use only in an enclosed system).
- Recommendations for personal protective measures to prevent illness or injury from exposure to chemicals, such as personal protective equipment (PPE) (e.g., appropriate types of eye, face, skin or respiratory protection needed based on hazards and potential exposure).
- Any special requirements for PPE, protective clothing or respirators (e.g., type of glove material, such as PVC or nitrile rubber gloves; and breakthrough time of the glove material).

### Section 9: Physical and Chemical Properties

This section identifies physical and chemical properties associated with the substance or mixture. The minimum required information consists of:

- Appearance (physical state, color, etc.);
- Odor;
- Odor threshold;
- pH;
- Melting point/freezing point;
- Initial boiling point and boiling range;
- Flash point;
- Evaporation rate;
- Flammability (solid, gas);
- Upper/lower flammability or explosive limits;
- Vapor pressure;
- Vapor density;
- Relative density;
- Solubility(ies);
- Partition coefficient: n-octanol/water;
- Auto-ignition temperature;
- Decomposition temperature; and
- Viscosity.

The SDS may not contain every item on the above list because information may not be relevant or is not available. When this occurs, a notation to that effect must be made for that chemical property. Manufacturers may also add other relevant properties, such as the dust deflagration index (Kst) for combustible dust, used to evaluate a dust's explosive potential.



## Section 10: Stability and Reactivity

This section describes the reactivity hazards of the chemical and the chemical stability information. This section is broken into three parts: reactivity, chemical stability, and other. The required information consists of:

### Reactivity

- Description of the specific test data for the chemical(s). This data can be for a class or family of the chemical if such data adequately represent the anticipated hazard of the chemical(s), where available.

### Chemical stability

- Indication of whether the chemical is stable or unstable under normal ambient temperature and conditions while in storage and being handled.
- Description of any stabilizers that may be needed to maintain chemical stability.
- Indication of any safety issues that may arise should the product change in physical appearance.

### Other

- Indication of the possibility of hazardous reactions, including a statement whether the chemical will react or polymerize, which could release excess pressure or heat, or create other hazardous conditions. Also, a description of the conditions under which hazardous reactions may occur.
- List of all conditions that should be avoided (e.g., static discharge, shock, vibrations, or environmental conditions that may lead to hazardous conditions).
- List of all classes of incompatible materials (e.g., classes of chemicals or specific substances) with which the chemical could react to produce a hazardous situation.
- List of any known or anticipated hazardous decomposition products that could be produced because of use, storage, or heating. (Hazardous combustion products should also be included in Section 5 (Fire-Fighting Measures) of the SDS.)

## Section 11: Toxicological Information

This section identifies toxicological and health effects information or indicates that such data are not available. The required information consists of:

- Information on the likely routes of exposure (inhalation, ingestion, skin and eye contact). The SDS should indicate if the information is unknown.
- Description of the delayed, immediate, or chronic effects from short- and long-term exposure.
- The numerical measures of toxicity (e.g., acute toxicity estimates such as the LD50 (median lethal dose)) - the estimated amount [of a substance] expected to kill 50% of test animals in a single dose.
- Description of the symptoms. This description includes the symptoms associated with exposure to the chemical including symptoms from the lowest to the most severe exposure.
- Indication of whether the chemical is listed in the National Toxicology Program (NTP) Report on Carcinogens (latest edition) or has been found to be a potential carcinogen in the International Agency for Research on Cancer (IARC) Monographs (latest editions) or found to be a potential carcinogen by OSHA.



### Section 12: Ecological Information (non-mandatory)

This section provides information to evaluate the environmental impact of the chemical(s) if it were released to the environment. The information may include:

- Data from toxicity tests performed on aquatic and/or terrestrial organisms, where available (e.g., acute or chronic aquatic toxicity data for fish, algae, crustaceans, and other plants; toxicity data on birds, bees, plants).
- Whether there is a potential for the chemical to persist and degrade in the environment either through biodegradation or other processes, such as oxidation or hydrolysis.
- Results of tests of bioaccumulation potential, making reference to the octanol-water partition coefficient ( $K_{ow}$ ) and the bioconcentration factor (BCF), where available.
- The potential for a substance to move from the soil to the groundwater (indicate results from adsorption studies or leaching studies).
- Other adverse effects (e.g., environmental fate, ozone layer depletion potential, photochemical ozone creation potential, endocrine disrupting potential, and/or global warming potential).

### Section 13: Disposal Considerations (non-mandatory)

This section provides guidance on proper disposal practices, recycling or reclamation of the chemical(s) or its container, and safe handling practices. To minimize exposure, this section should also refer the reader to Section 8 (Exposure Controls/Personal Protection) of the SDS. The information may include:

- Description of appropriate disposal containers to use.
- Recommendations of appropriate disposal methods to employ.
- Description of the physical and chemical properties that may affect disposal activities.
- Language discouraging sewage disposal.
- Any special precautions for landfills or incineration activities.

### Section 14: Transport Information (non-mandatory)

This section provides guidance on classification information for shipping and transporting of hazardous chemical(s) by road, air, rail, or sea. The information may include:

- UN number (i.e., four-figure identification number of the substance)<sup>2</sup>.
- UN proper shipping name<sup>2</sup>.
- Transport hazard class(es)<sup>2</sup>.
- Packing group number, if applicable, based on the degree of hazard<sup>2</sup>.
- Environmental hazards (e.g., identify if it is a marine pollutant according to the International Maritime Dangerous Goods Code (IMDG Code)).
- Guidance on transport in bulk (according to Annex II of MARPOL 73/78<sup>3</sup> and the International Code for the Construction and Equipment of Ships Carrying Dangerous Chemicals in Bulk (International Bulk Chemical Code (IBC Code))).
- Any special precautions which an employee should be aware of or needs to comply with, in connection with transport or conveyance either within or outside their premises (indicate when information is not available).

<sup>2</sup>Found in the most recent edition of the United Nations Recommendations on the Transport of Dangerous Goods.

<sup>3</sup>MARPOL 73/78 means the International Convention for the Prevention of Pollution from Ships, 1973, as modified by the Protocol of 1978 relating thereto, as amended.





### Section 15: Regulatory Information (non-mandatory)

This section identifies the safety, health, and environmental regulations specific for the product that is not indicated anywhere else on the SDS. The information may include:

- Any national and/or regional regulatory information of the chemical or mixtures (including any OSHA, Department of Transportation, Environmental Protection Agency, or Consumer Product Safety Commission regulations).

### Section 16: Other Information

This section indicates when the SDS was prepared or when the last known revision was made. The SDS may also state where the changes have been made to the previous version. You may wish to contact the supplier for an explanation of the changes. Other useful information also may be included here.

#### Employer Responsibilities

Employers must ensure that the SDSs are readily accessible to employees for all hazardous chemicals in their workplace. This may be done in many ways. For example, employers may keep the SDSs in a binder or on computers as long as the employees have immediate access to the information without leaving their work area when needed and a back-up is available for rapid access to the SDS in the case of a power outage or other emergency. Furthermore, employers may want to designate a person(s) responsible for obtaining and maintaining the SDSs. If the employer does not have an SDS, the employer or designated person(s) should contact the manufacturer to obtain one.

#### References

OSHA, 29 CFR 1910.1200(g) and Appendix D.  
United Nations Globally Harmonized System of Classification and Labelling of Chemicals (GHS), third revised edition, United Nations, 2009.  
These references and other information related to the revised Hazard Communication

Standard can be found on OSHA's Hazard Communication Safety and Health Topics page, located at:  
<http://www.osha.gov/dsg/hazcom/index.html>.

Disclaimer: This brief provides a general overview of the safety data sheet requirements in the Hazard Communication Standard (see 29 CFR 1910.1200(g) and Appendix D of 29 CFR 1910.1200). It does not alter or determine compliance responsibilities in the standard or the Occupational Safety and Health Act of 1970. Since interpretations and enforcement policy may change over time, the reader should consult current OSHA interpretations and decisions by the Occupational Safety and Health Review Commission and the courts for additional guidance on OSHA compliance requirements. Please note that states with OSHA-approved state plans may have additional requirements for chemical safety data sheets, outside of those outlined above. For more information on those standards, please visit:  
<http://www.osha.gov/dcsp/osp/statestandards.html>.

**This is one in a series of informational briefs highlighting OSHA programs, policies or standards. It does not impose any new compliance requirements. For a comprehensive list of compliance requirements of OSHA standards or regulations, refer to Title 29 of the Code of Federal Regulations. This information will be made available to sensory-impaired individuals upon request. The voice phone is (202) 693-1999; teletypewriter (TTY) number: (877) 889-5627.**

**For assistance, contact us. We can help. It's confidential.**



U.S. Department of Labor  
[www.osha.gov](http://www.osha.gov) (800) 321-OSHA (6742)

DSG BR-3514 2/2012

